



traveling with you

Bottari
I T A L Y

www.Bottari.it

CATALOGO AUTOMOTIVE



**È LA PASSIONE
CHE CI MUOVE
LA STESSA DI SEMPRE**

Salone di Francoforte



GAMMA LUBRIFICANTI
LUBRICANTS RANGE



OLIO BASE - OLIO SINT pag 16
OLIO ULTRA SINT pag 17
OLIO MOTO - OLIO UTENSILI pag 18

BATTERIE
BATTERIES



BATTERIE GOODYEAR pag 22
BATTERIE XTRA pag 25

PULIZIA PROTEZIONE & LINEA PET
CLEANING PROTECTION AND PET LINE



LINEA PET pag 30
CHIMICO GOODYEAR pag 36
CHIMICO GULF pag 58
CHIMICO BOTTARI pag 61
ACCESSORI PULIZIA E PROTEZIONE pag 70

TERGICRISTALLI
WIPER BLADES



SPAZZOLE TERGICRISTALLI GOODYEAR pag 96
SPAZZOLE TERGICRISTALLI BOTTARI pag 98
SPAZZOLE TERGICRISTALLI X-TRA pag 101
GOMMINI RICAMBIO
SPAZZOLE TERGICRISTALLI BOTTARI pag 102
GRAPHITE
SPAZZOLE TERGICRISTALLI X-TRA pag 103
APPLICATIVO SPAZZOLE pag 104
ESPOSITORI SPAZZOLE pag 112

ILLUMINAZIONE
CAR LIGHTING



LAMPADINE GOODYEAR pag 116
LAMPADINE XTRA pag 119
LAMPADINE BOTTARI pag 121
TROUSSE E LAMPADINE MICRO BOTTARI pag 125
LAMPADINE XTRA pag 126
LUCI GOODYEAR pag 129
LUCI XTRA-LAMPADINA MOTO pag 130
ESPOSITORI - GUIDA APPLICAZIONE pag 131
LAMPADINE

RUOTE
WHEELS



CATENE DA NEVE GOODYEAR pag 134
CATENE DA NEVE GULF pag 142
CATENE DA NEVE BOTTARI pag 144
CALZE DA NEVE BOTTARI pag 152
CATENE DA NEVE TRUCK BOTTARI pag 153
COPRIGERCHI GOODYEAR pag 154
COPERTURA PNEUMATICI - PORTAGOMME GOODYEAR pag 156
COPRIGERCHI BOTTARI pag 158
ACCESSORI RUOTE pag 164

TAPPETI
CAR MATS



TAPPETI SU MISURA IN MOQUETTE pag 170
TAPPETI SU MISURA IN GOMMA pag 171
TAPPETI IN GOMMA E MOQUETTE GOODYEAR pag 174
TAPPETI IN MOQUETTE E GOMMA BOTTARI pag 177
TAPPETI IN GOMMA E PVC pag 184
TAPPETI IN GOMMA E BATTITACCO IN MOQUETTE pag 185
TAPPETI IN GOMMA E LAMINATI pag 186
ESPOSITORE TOTEM TAPPETI pag 188

FODERE E COPRISIEDILI
SEAT COVERS AND SEAT CUSHIONS



COPRISIEDILI IN LINO pag 192
COMPLETO FODERE BOTTARI pag 194
COMPLETO FODERE LADY pag 196
COMPLETO FODERE UNIVERSALI pag 199
SET FODERE UNIVERSALI pag 200
COPRISIEDILE - FODERA UNIVERSALE pag 202
SCHIENALE BOTTARI pag 203
SCHIENALE - FODERA GOODYEAR pag 209
COMPLETO FODERE GOODYEAR pag 210
COPRISIEDILE GOODYEAR E GULF pag 211

ACCESSORI INTERNI
INTERIOR ACCESSORIES

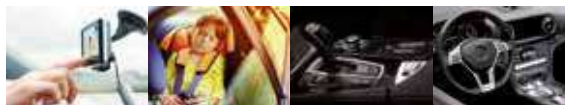

COPRIVOLANTI GOODYEAR pag 214
COPRIVOLANTI BOTTARI pag 215
COPRIVOLANTI BOTTARI-REVOLUTION pag 216
POMELLI pag 219
BRACCIOLI pag 220
PROTEGGI E SALVA SEDILE pag 221
SEGGIOLINI PER BAMBINI pag 222
ACCESSORI BOTTARI pag 223
GRIGLIE E RETI DI SEPARAZIONE pag 224
PEDANA MULTIUSO GOODYEAR pag 225
PEDANA MULTIUSO BOTTARI pag 226
ACCESSORI BOTTARI E GOODYEAR pag 228

INDICE

PORTAGGIO CARRYING SYSTEMS



BARRE PORTATUTTO GOODYEAR pag 234
PORTABICI pag 236
PORTABICI-RETE BAGAGLI-ROOMY pag 237
BAULE pag 238
BOX AUTO

ACCESSORI ESTERNI EXTERIOR ACCESSORIES



SALVAPORTA - SALVAURTI pag 242
TAPPI BENZINA - SPECCHIETTO pag 244
AUSILIARIO
PORTATARGA CON RETROCAMERA
ADESIVI VELOCITÀ - CORDE ELASTICHE pag 245
CINGHIE DI FISSAGGIO pag 246

SOS SOS ACCESSORIES



ACCESSORI SOS pag 250

DEODORANTI PERFUMES

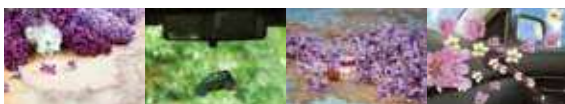

SCENTED MINI BOTTLE - JELLO pag 268
INTENSE - AIR PERFUME - TULIP CLASSIC pag 269
MON LUX - X VERSION - DRY SMILE pag 270
MON CLASSIC - SPORT LUX pag 271
MY PUPPY pag 272
ARBRE MAGIQUE pag 273
BRACCIALETTA ALLONTANA ZANZARE pag 274

MANUTENZIONE-ELETRICI HARDWARE TOOLS - ELETRICAL ITEMS



MANUTENZIONE pag 278
ELETRICI pag 284

EMERGENZA TENDINE E PARASOLI EMERGENCY ITEMS - SUN SHADES - SUN CURTAINS



EMERGENZA pag 296
TENDINE E PARASOLI pag 306

ANTIFURTI E ANTENNE **GUANTI DA LAVORO** ANTITHEFT & ANTENNAS - WORKING GLOVES



ANTIFURTI E ANTENNE pag 316
GUANTI DA LAVORO pag 320

REVOLUTION GIRL **REVOLUTION** REVOLUTION GIRL - REVOLUTION ACCESSORIES



REVOLUTION GIRL pag 324
REVOLUTION pag 336

CAMION TRUCK ACCESSORIES



COPRIVOLANTE - CARTA CARBURANTE pag 348
IDROSPAZZOLE - MANICI pag 349
ACCESSORI pag 350
CORDA TRAINO - KIT CHIAVI pag 351
ASPIRAPOLVERE - CAVI BATTERIA pag 352
CINGHIA DI FISSAGGIO - KIT VALIGETTA pag 353
PRONTO SOCCORSO
CATENE pag 354
ESTINTORI - ACCENDISIGARI pag 355

MOTO E BICI MOTORBIKE AND BIKE ACCESSORIES



MOTO ACCESSORIES pag 358
BIKE ACCESSORIES pag 390

SUPPORTO ALLA VENDITA DISPLAY STANDS



ESPOSITORI IN CARTONE DA TERRA pag 452
ESPOSITORI DA TERRA pag 454
ESPOSITORE PER SPAZZOLE pag 455
ESPOSITORI IN CARTONE DA BANCO pag 456
ESPOSITORI IN CARTONE A CASSETTI pag 457
GANCI E CARTELLINO pag 458
ESPOSITORE 4 PIANI EXPOPLASTIC pag 459
ESPOSITORE TOTEM pag 460
ESPOSITORE pag 461



*“Non smettere mai di investire,
innovare, ricercare e soprattutto osare,
è la chiave vincente in questi tempi
difficili”* Guido Bottari



ACCESSORI AUTO MOTO BICI



**INVENTA
CREA
INNOVA
MIGLIORA**

From a small company to a large international group present in over 60 countries around the world: Bottari Spa, specialized in the production of accessories for cars, motorcycles and bicycles, has traced the road in this complex and varied market right from the start leader of reference, innovating and inventing, exploring and researching, never stopping to do it.

Bottari seleziona le novità e le migliori referenze presenti nel mercato mondiale degli accessori per auto, moto e bici; dai prodotti altamente specializzati, ai prodotti nati per soddisfare le esigenze di un ampio bacino di utenza.



Da piccola realtà artigianale a grande azienda internazionale presente in oltre 60 paesi del mondo: Bottari Spa, specializzata nella produzione di accessori per auto, moto e ciclo, ha tracciato sin dall'inizio la strada in questo complesso e variegato mercato, imponendosi da subito come leader di riferimento, innovando ed inventando, esplorando e ricercando, senza fermarsi mai.

CONTATTI

PHONE: +39 0375 868111

FAX: +39 0375 868150

MAIL: bottari@bottari.it

WEB-SITE: www.bottari.it

BOTTARI È OGGI PRESENTE SUL
MERCATO NAZIONALE
ED ESTERO CON I PROPRI
MARCHI: BOTTARI,
R.EVOLUTION, R.EVOLUTION
MOTORBIKE, GOODBYKE, X-TRA,
WIPER E CON TANTI MARCHI
A LICENZA, TRA I QUALI
GOODYEAR E GULF.



Taglia il traguardo dei

LA STORIA DEL BRAND

BOTTARI HISTORY OF THE LOGO



Il marchio **Bottari** nasce negli anni 60 dimostrandosi già molto forte per i tratti decisi e per l'uso del colore rosso. L'idea iniziale era quella di richiamare attraverso viti e forme geometriche il mondo delle quattro ruote, da noi tanto amato.

The **Bottari** logo was born in the 60's since the beginning proving to be very strong for the bold strokes and the use of the red color. The initial idea was to recall through shapes and screws through the world of the four wheels, which we love so much.



Nel 2006 abbiamo deciso di ripensare alla nostra immagine aziendale "illuminando" il mercato con il nostro ormai famoso "logo giallo su fondo nero". Un vero cambiamento sia nel lettering che nel colore, ma noi adoriamo le sfide!

In 2006, we decided to rewrite our corporate image "illuminating" the market with our now famous "yellow logo on a black background." A real change both in lettering than in the color, but we love challenges!



Per il nostro restyling attuale abbiamo voluto unitarietà di forma e di concetto: le curve esprimono propagazione di energia e la passione per le curve della strada che sono in continuo movimento, come noi. L'energia, l'italianità e la strada sono il nostro business, la nostra passione e il nostro modo di affrontare le sfide.

For our current restyling we wanted unity of form and concept: the curves express the propagation of energy and the passion for the curves of the road that are in constant motion, like us. The energy, the Italian tradition and the road are our business, our passion and our way of dealing with the challenges.

UN'AZIENDA DINAMICA

Bottari seleziona le novità e le migliori referenze presenti nel mercato mondiale degli accessori per auto, moto e bici; dai prodotti altamente specializzati, ai prodotti nati per soddisfare le esigenze di un ampio bacino di utenza. L'esperienza ed il know-how del Gruppo sono una garanzia per i suoi clienti nel mondo.

Con 60 anni di storia, Bottari rappresenta un punto di riferimento per gli operatori del settore, assicurando un servizio logistico tempestivo e puntuale, e rispondendo alle varie e mutevoli esigenze del mercato.

I punti di forza sono: l'ampiezza di assortimento, la diversificazione dell'offerta, l'ottimo rapporto qualità-prezzo, la competenza della rete di vendita, l'efficienza del sistema logistico, la continua ricerca di mercato, la cura nel design, nel packaging e nel sistema espositivo dei prodotti, sempre unico ed innovativo.



Bottari selects the latest news and the best references on the worldwide market of accessories for cars, motorcycles and bicycles; from highly specialized products, to products created to meet the needs of all the consumers. The Group's experience and know-how are a guarantee for its customers worldwide.

With 60 years of history, Bottari represents a point of reference for the operators of the sector, ensuring a timely and punctual logistic service, and responding to the various and changing needs of the market.

The strengths are: the breadth of assortment, the diversification of the offer, the excellent quality-price ratio, the competence of the sales network, the efficiency of the logistics system, the continuous market research, the care in the design, in the packaging and in the display system of the products, always unique and innovative.



NOW





www.Bottari.it
Bottari
I T A L Y

...along the road

*dove c'è Bottari,
c'è una strada*

Oggi il catalogo conta oltre 6.000 referenze, con un trend di crescita sempre costante; i prodotti Bottari sono distribuiti presso tutti i canali commerciali esistenti: negozi specializzati di accessori auto, ricambisti, grossisti, stazioni di servizio, gommisti, officine, concessionarie auto, ferramenta, grande distribuzione organizzata, ipermercati.

Today the catalog has more than 6,000 references, with a constant growth trend; Bottari products are distributed in all the existing commercial channels: specialized shops for car accessories, spare parts dealers, wholesalers, service stations, tire shops, workshops, car dealers, hardware stores, large-scale retail trade, hypermarkets.



SVILUPPO E COMPETENZE

I PUNTI DI FORZA DEL GRUPPO



KNOW HOW

L'indiscussa qualità dei prodotti presenti nel proprio catalogo rende la Bottari un riferimento per tutti gli operatori del settore, interessati al continuo aggiornamento delle novità di mercato ed al riassortimento costante degli articoli a scaffale.

LOGISTICA E DISTRIBUZIONE

Bottari si avvale di una moderna piattaforma logistica presso lo stabilimento centrale di Pomponesco (Mn) con una superficie coperta di oltre 25.000 mq e 60.000 posti pallet, di un'organizzazione distributiva capillare, flessibile e sempre tempestiva ed in sintonia con la velocità del mercato. Precisione e rapidità nell'evasione degli ordini sono sempre al primo posto per soddisfare appieno la clientela.

SOLUZIONI PER OGNI ESIGENZA

Un'attenzione speciale viene dedicata alla continua ricerca di nuovi prodotti, per soddisfare le più svariate esigenze e per essere sempre al passo con i tempi del mercato. Bottari studia le soluzioni specifiche per ogni canale di vendita, con un occhio di riguardo al packaging, per essere sempre attraenti e riconoscibili al primo sguardo; su richiesta presenta anche un'ampia offerta di espositori per il supporto alla vendita, al fine di perfezionare ulteriormente la presentazione del prodotto.



KNOW HOW

The undisputed quality of the products in its catalog makes Bottari a reference for all the operators in the sector, interested in the continuous updating of market news and the constant re-assortment of items on the shelf.

LOGISTICS AND DISTRIBUTION

Bottari uses a modern logistics platform at the central plant of Pomponesco (Mn) with a covered area of over 25.000 square meters and 60.000 pallets, a capillary distribution organization, flexible and always timely and in tune with the speed of the market. Accuracy and speed in order processing are always in first place to fully satisfy customers.

EVERY NEEDS SOLUTIONS

Special attention is given to the continuous search for new products, to meet the most varied needs and to keep pace with the times of the market. Bottari studies the specific solutions for each sales channel, with an eye to the packaging, to always be attractive and recognizable at first glance; on request it also presents a wide range of displays for sales support, in order to further refine the presentation of the product.





AUTO

MOTO

BICI



VIAGGIA CON TE
Travel with you

INDICE ILLUSTRATO DEL CATALOGO

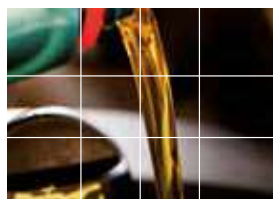

PAG 15
LUBRIFICANTI
Lubricants range

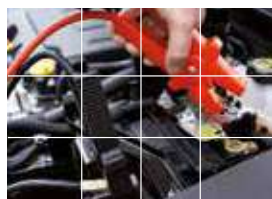

PAG 21
BATTERIE
Batteries

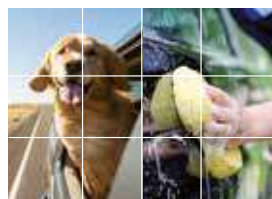

PAG 29
**PULIZIA
PROTEZIONE
PET**
*Cleaning protection
and pet line*



PAG 95
TERGICRISTALLI
Wiper blades



PAG 115
ILLUMINAZIONE
Car lighting



PAG 133
RUOTE
Wheels



PAG 169
TAPPETI
Car mats



PAG 191
**FODERE E
COPRISIEDILI**
*Seat covers and seat
cushions*

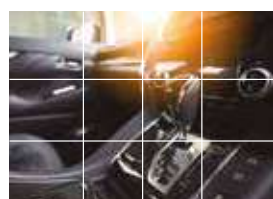

PAG 213
ACC. INTERNI
Interior accessories



PAG 233
PORTAGGIO
Carrying systems



PAG 241
ACC. ESTERNI
Exterior accessories



PAG 249
SOS
Sos accessories



PAG 267
DEODORANTI
Perfumes



PAG 277
**MANUTENZIONE
ELETTRICI**
*Hardware tools
electrical items*



PAG 295
**EMERGENZA
TENDINE
PARASOLI**
*Emergency items
sun shades*



PAG 315
**ANTIFURTI
ANTENNE
GUANTI**
*Antitheft & antennas
working gloves*

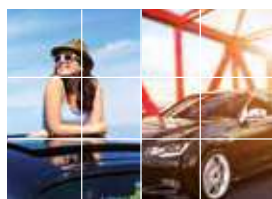

PAG 323
**REVOLUTION
GIRL
REVOLUTION**
*Revolution girl
revolution accessories*



PAG 347
CAMION
Truck accessories



PAG 357
MOTO E BICI
*Motorbike and bike
accessories*



PAG 451
SUPP.VENDITA
Display stands



GAMMA LUBRIFICANTI

LUBRIFICANTS RANGE

SUPPORTO VENDITA LUBRIFICANTI



www.Bottari.it
Bottari
ITALY



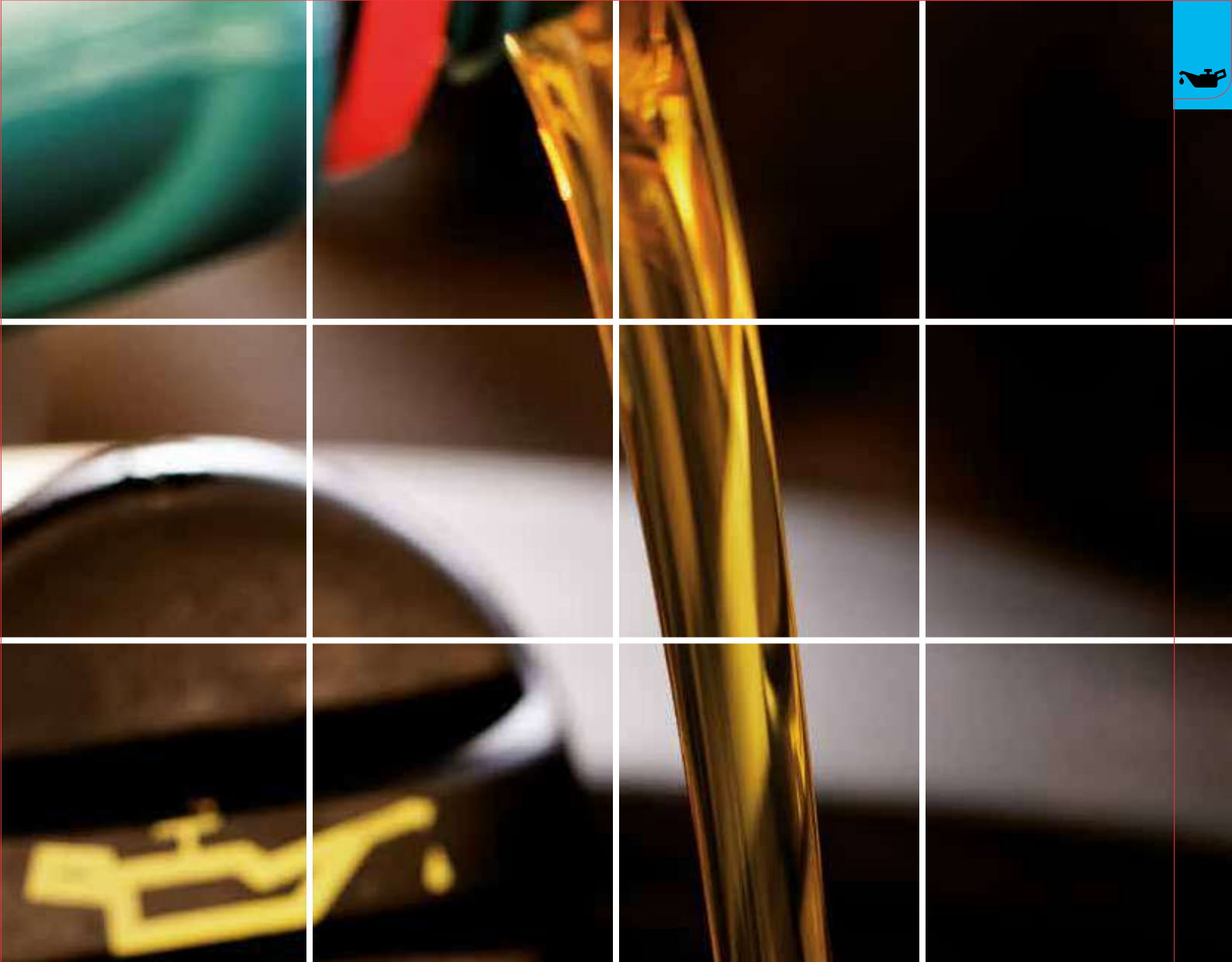

GAMMA LUBRIFICANTI

LUBRICANTS RANGE

OLIO BASE - OLIO SINT pag 16
OLIO ULTRA SINT pag 17
OLIO MOTO - OLIO UTENSILI pag 18



OLIO BASE MULTIGRADE 15W-40

55518 - 1L. MASTER 12

Lubrificante a base multigrado minerale di altissime prestazioni per motori a benzina, diesel, turbodiesel, metano e gpl, aspirati o turbocompressi. La sua speciale formulazione assicura elevati standard di pulizia e protezione antiusura, ideale anche per rabbocchi, è idoneo per veicoli muniti di marmitta catalitica, per autovetture e veicoli commerciali leggeri. Formulato con basi minerali. **Garantisce intervalli di cambio prolungati**, massima protezione e pulizia del motore grazie alle spiccate caratteristiche di detergenza e disperdenza, protegge da corrosione e ruggine, massima reattività nelle partenze in climi freddi. Le molecole di **BOTTARI BASE MULTIGRADE** proteggono dal primo istante aderendo alle superfici del motore più soggette a sollecitazioni. La formula di protezione antiusura mantiene pulito il motore, con una totale assenza di depositi su cilindri, pistoni, valvole, candele e turbocompressori.



SAE **15W-40**

API SL/CF
ACEA A3/B3
MB 229.1
VW 501.01/505.00

BENZINA - DIESEL
TURBODIESEL - METANO - GPL

OLIO BASE MULTIGRADE 15W-40

55519 - 4L. MASTER 4

Lubrificante a base multigrado minerale di altissime prestazioni per motori a benzina, diesel, turbodiesel, metano e gpl, aspirati o turbocompressi. La sua speciale formulazione assicura elevati standard di pulizia e protezione antiusura, ideale anche per rabbocchi, è idoneo per veicoli muniti di marmitta catalitica, per autovetture e veicoli commerciali leggeri. Formulato con basi minerali. **Garantisce intervalli di cambio prolungati**, massima protezione e pulizia del motore grazie alle spiccate caratteristiche di detergenza e disperdenza, protegge da corrosione e ruggine, massima reattività nelle partenze in climi freddi. Le molecole di **BOTTARI BASE MULTIGRADE** proteggono dal primo istante aderendo alle superfici del motore più soggette a sollecitazioni. La formula di protezione antiusura mantiene pulito il motore, con una totale assenza di depositi su cilindri, pistoni, valvole, candele e turbocompressori.



SAE **15W-40**

API SL/CF
ACEA A3/B3
MB 229.1
VW 501.01/505.00

BENZINA - DIESEL
TURBODIESEL - METANO - GPL

OLIO SINT PLUS EXCELLENT 10W-40

55520 - 1L. MASTER 12

Lubrificante a base sintetica di altissime prestazioni per motori a benzina, diesel, turbodiesel, metano e gpl anche moderni, aspirati o turbocompressi. La sua speciale formulazione assicura elevati standard di pulizia e protezione antiusura, idoneo anche per rabbocchi, miscelabile con prodotti a base minerale, è ideale per autovetture munite di marmitta catalitica. Formulato con basi sintetiche non rigenerate. **Garantisce intervalli di cambio prolungati**, massima protezione e pulizia del motore, nonché reattività nelle partenze in climi freddi. Le molecole di **BOTTARI SINT PLUS** proteggono dal primo istante aderendo alle superfici del motore più soggette ad usura.



SAE **10W-40**

API SL/CF
ACEA A3/B3
ACEA A3/B4
MB 229.1
VW 501.01/505.00

BENZINA - DIESEL
TURBODIESEL - METANO - GPL

OLIO SINT PLUS EXCELLENT 10W-40

55521 - 4L. MASTER 4

Lubrificante a base sintetica di altissime prestazioni per motori a benzina, diesel, turbodiesel, metano e gpl anche moderni, aspirati o turbocompressi. La sua speciale formulazione assicura elevati standard di pulizia e protezione antiusura, idoneo anche per rabbocchi, miscelabile con prodotti a base minerale, è ideale per autovetture munite di marmitta catalitica. Formulato con basi sintetiche non rigenerate. **Garantisce intervalli di cambio prolungati**, massima protezione e pulizia del motore, nonché reattività nelle partenze in climi freddi. Le molecole di **BOTTARI SINT PLUS** proteggono dal primo istante aderendo alle superfici del motore più soggette ad usura.



SAE **10W-40**

API SL/CF
ACEA A3/B3
ACEA A3/B4
MB 229.1
VW 501.01/505.00

BENZINA - DIESEL
TURBODIESEL - METANO - GPL



OLIO ULTRA SINT LONGLIFE III 5W-40

55522 - 1L. MASTER 12

Lubrificante **totalmente sintetico di altissime prestazioni** per motori a **benzina, diesel, turbodiesel, metano e gpl** di ultima generazione, aspirati o turbocompressi, equipaggiati con sistemi di post-trattamento dei gas esausti (catalizzatori e filtri antiparticolati: DPF, FAP...). La sua speciale formulazione assicura elevati standard di pulizia e protezione antiusura, idoneo anche per rabbocchi. Formulato con basi sintetiche non rigenerate. La gradazione **SAE 5W-40** è particolarmente studiata per la riduzione del consumo di carburante ("Fuel Economy"). **Garantisce intervalli di cambio prolungati**, massima protezione e pulizia del motore, nonché reattività nelle partenze in climi freddi. Le molecole di **BOTTARI ULTRA SINT** proteggono dal primo istante aderendo alle superfici del motore più soggette a usura.



SAE **5W-40**

API SM/SL/CF
ACEA A3/B4
MB 229.3/229.5
VW 501.01/502.00/505.00
BMW LL-01
RENAULT RN0710/0700
PSA B71 2296
OPEL GM GM-LL-A-025/LL-B-025
FIAT 9.55535-G2/D3

BENZINA - DIESEL
TURBODIESEL - METANO - GPL

OLIO ULTRA SINT LONGLIFE III 5W-40

55523 - 4L. MASTER 4

Lubrificante **totalmente sintetico di altissime prestazioni** per motori a **benzina, diesel, turbodiesel, metano e gpl** di ultima generazione, aspirati o turbocompressi, equipaggiati con sistemi di post-trattamento dei gas esausti (catalizzatori e filtri antiparticolati: DPF, FAP...). La sua speciale formulazione assicura elevati standard di pulizia e protezione antiusura, idoneo anche per rabbocchi. Formulato con basi sintetiche non rigenerate. La gradazione **SAE 5W-40** è particolarmente studiata per la riduzione del consumo di carburante ("Fuel Economy"). **Garantisce intervalli di cambio prolungati**, massima protezione e pulizia del motore, nonché reattività nelle partenze in climi freddi. Le molecole di **BOTTARI ULTRA SINT** proteggono dal primo istante aderendo alle superfici del motore più soggette a usura.



SAE **5W-40**

API SM/SL/CF
ACEA A3/B4
MB 229.3/229.5
VW 501.01/502.00/505.00
BMW LL-01
RENAULT RN0710/0700
PSA B71 2296
OPEL GM GM-LL-A-025/LL-B-025
FIAT 9.55535-G2/D3

BENZINA - DIESEL
TURBODIESEL - METANO - GPL

OLIO ULTRA SINT LONGLIFE III 5W-30

55524 - 1L. MASTER 12

Lubrificante **totalmente sintetico di altissime prestazioni** per motori a **benzina, diesel, turbodiesel, metano e gpl** di ultima generazione, aspirati o turbocompressi, equipaggiati con sistemi di post-trattamento dei gas esausti (catalizzatori e filtri antiparticolati: DPF, FAP...). La sua speciale formulazione assicura elevati standard di pulizia e protezione antiusura, idoneo anche per rabbocchi. Formulato con basi sintetiche non rigenerate. La gradazione **SAE 5W-30** è particolarmente studiata per la riduzione del consumo di carburante ("Fuel Economy"). **Garantisce intervalli di cambio prolungati**, massima protezione e pulizia del motore, nonché reattività nelle partenze in climi freddi. Le molecole di **BOTTARI ULTRA SINT** proteggono dal primo istante aderendo alle superfici del motore più soggette a usura.



SAE **5W-30**

API SM/SL/CF
ACEA A3/B4
FIAT 9.55535-G2/D2
MB 229.3/229.5
VW 505.01/502.00/505.00
OPEL GM-LL-A-025/LL-B-025
BMW LL-01
PSA B71 2296
RENAULT RN0710/0700

BENZINA - DIESEL
TURBODIESEL - METANO - GPL

OLIO ULTRA SINT LONGLIFE III 5W-30

55525 - 4L. MASTER 4

Lubrificante **totalmente sintetico di altissime prestazioni** per motori a **benzina, diesel, turbodiesel, metano e gpl** di ultima generazione, aspirati o turbocompressi, equipaggiati con sistemi di post-trattamento dei gas esausti (catalizzatori e filtri antiparticolati: DPF, FAP...). La sua speciale formulazione assicura elevati standard di pulizia e protezione antiusura, idoneo anche per rabbocchi. Formulato con basi sintetiche non rigenerate. La gradazione **SAE 5W-30** è particolarmente studiata per la riduzione del consumo di carburante ("Fuel Economy"). **Garantisce intervalli di cambio prolungati**, massima protezione e pulizia del motore, nonché reattività nelle partenze in climi freddi. Le molecole di **BOTTARI ULTRA SINT** proteggono dal primo istante aderendo alle superfici del motore più soggette a usura.



SAE **5W-30**

API SM/SL/CF
ACEA A3/B4
FIAT 9.55535-G2/D2
MB 229.3/229.5
VW 505.01/502.00/505.00
OPEL GM-LL-A-025/LL-B-025
BMW LL-01
PSA B71 2296
RENAULT RN0710/0700

BENZINA - DIESEL
TURBODIESEL - METANO - GPL



OLIO MOTO SCOOTER 2T ULTRA TOP 50

55550 - 1L. MASTER 12

Lubrificante moto a base multigrado minerale di altissime prestazioni per motori, scooter, barche, attrezzature per il giardinaggio, piccoli generatori, ecc... a due tempi raffreddati ad aria e ad acqua con miscelazione automatica o premiscelata. Utilizzabile sia con le benzine normali che senza piombo. La composizione già prefluidificata, ideale per i sistemi a lubrificazione separata, consente una più facile preparazione quando l'erogazione avviene in forma premiscelata. La sua formulazione garantisce massima protezione anche nelle condizioni di guida più estreme, assicurando elevati standard di pulizia, grazie alle spiccate caratteristiche di detergenza. Le molecole di **BOTTARI ULTRA TOP 50** assicurano la riduzione della fumosità allo scarico ed evita la formazione di depositi su candele, pistoni e luci di scarico.



ULTRA TOP 50

MOTO SCOOTER 2T

API TB
JASO FB
ISO L-EG8

**MINIMA FUMOSITÀ
MASSIME PRESTAZIONI**

OLIO MOTO SCOOTER 2T SINT TOP 50

55551 - 1L. MASTER 12

Lubrificante moto a base sintetica di altissime prestazioni a basso contenuto di ceneri e arricchito con particolari additivi che assicurano al motore il mantenimento delle prestazioni. Ideale per motori e scooter a due tempi anche di ultima generazione raffreddati ad aria e ad acqua con o senza marmitta catalitica. Favorisce la pulizia della camera di combustione e riduce l'usura dei componenti del motore, cilindro, fasce e pistone. Utilizzabile sia con le benzine normali che senza piombo. La sua formulazione garantisce massima protezione anche nelle condizioni di guida più estreme. Compatibile con tutti i materiali usati per le tenute e le guarnizioni. La sua speciale formulazione assicura elevati standard di pulizia e protezione antiusura, grazie alle spiccate caratteristiche di detergenza. Le molecole di **BOTTARI SINT TOP 50** assicurano la riduzione della fumosità allo scarico ed evitano la formazione di depositi assicurando prestazioni brillanti per ogni tipo di guida. Può essere utilizzato anche in sistemi con premiscelatore.



SINT TOP 50

MOTO SCOOTER 2T

API TC
JASO FD
ISO L-EG8

**MINIMA FUMOSITÀ
MASSIME PRESTAZIONI**

OLIO SINT TOP 4T 10W-40

55552 - 1L. MASTER 12

Lubrificante moto a base sintetica di ultima concezione. Altissime prestazioni a basso contenuto di ceneri e arricchito con particolari additivi che assicurano al motore il mantenimento delle prestazioni. Solo un lubrificante rafforzato con basi sintetiche di prima qualità può garantire l'efficienza del motore e il mantenimento delle prestazioni nel tempo. Se la tua moto o il tuo scooter vengono usati in condizioni stressanti, anche con due passeggeri e con elaborazioni necessitano del più alto livello di protezione e pulizia interna, in qualsiasi stagione. Ideale per motori, scooter e quad ecc... a quattro tempi anche di ultima generazione. Favorisce la pulizia della camera di combustione e riduce l'usura dei componenti del motore, cilindro, fasce e pistone. La sua formulazione garantisce massima protezione anche nelle condizioni di guida più estreme. Compatibile con tutti i materiali usati per le tenute e le guarnizioni. La sua speciale formulazione assicura elevati standard di pulizia e protezione antiusura, grazie alle spiccate caratteristiche di detergenza. Le molecole di **BOTTARI SINT TOP 10W-40** assicurano la riduzione della fumosità allo scarico ed evitano la formazione di depositi assicurando prestazioni brillanti per ogni tipo di guida.



SINT TOP 10W-40

MOTO SCOOTER 4T

API SL
JASO MA2

**MINIMA FUMOSITÀ
MASSIME PRESTAZIONI**

OLIO UTENSILI ISO VG 100

55079 - 1L. MASTER 12

Olio lubrificante per utensili e compressori. Olio minerale di elevata qualità per compressori ed impianti idraulici in genere, per lubrificazione generale ed impieghi vari a circolazione. Idoneo alle basse temperature. Impedisce il formarsi della ruggine anche in presenza di elevata umidità. Ottime proprietà antiusura.



**OLIO LUBRIFICANTE
PER UTENSILI E COMPRESSORI**



**ALTA VISCOSITÀ
ELEVATA DURATA
NEL TEMPO
ANTIOSSIDANTE
ANTICORROSIONE**

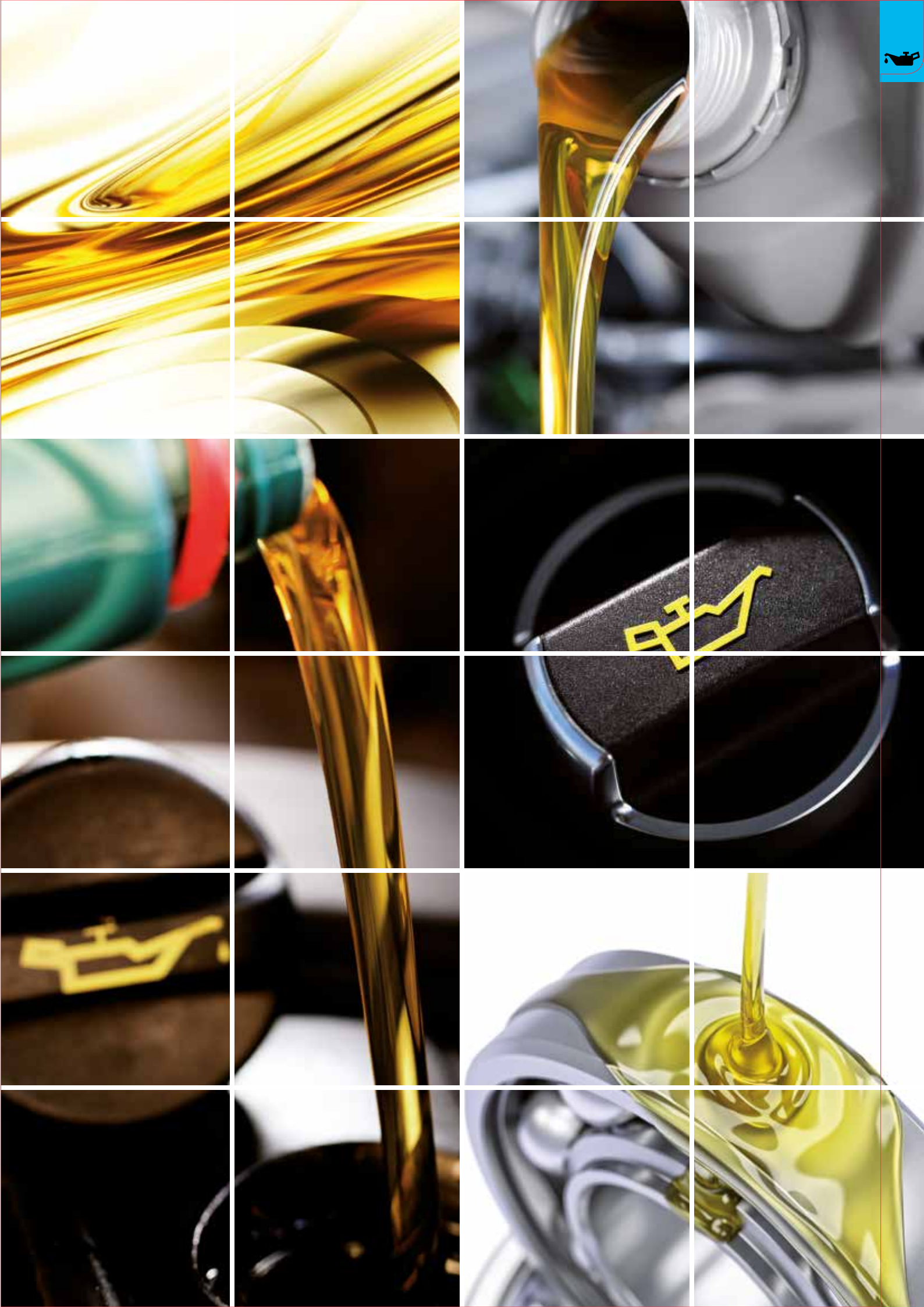

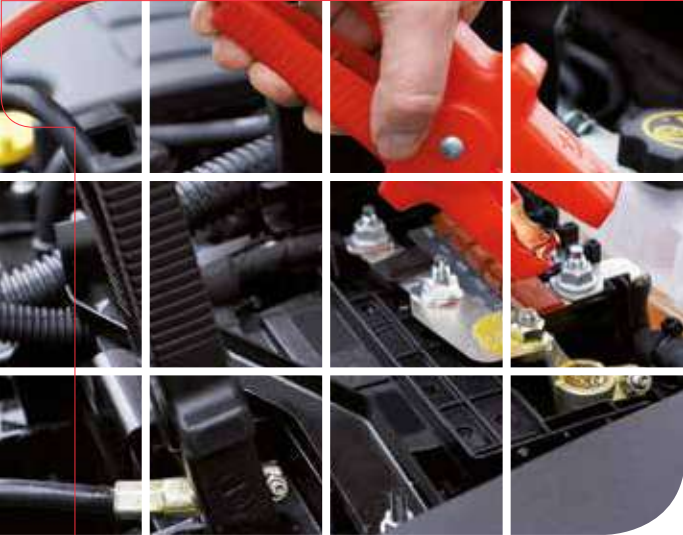

BATTERIE

BATTERIES

SUPPORTO VENDITA BATTERIE



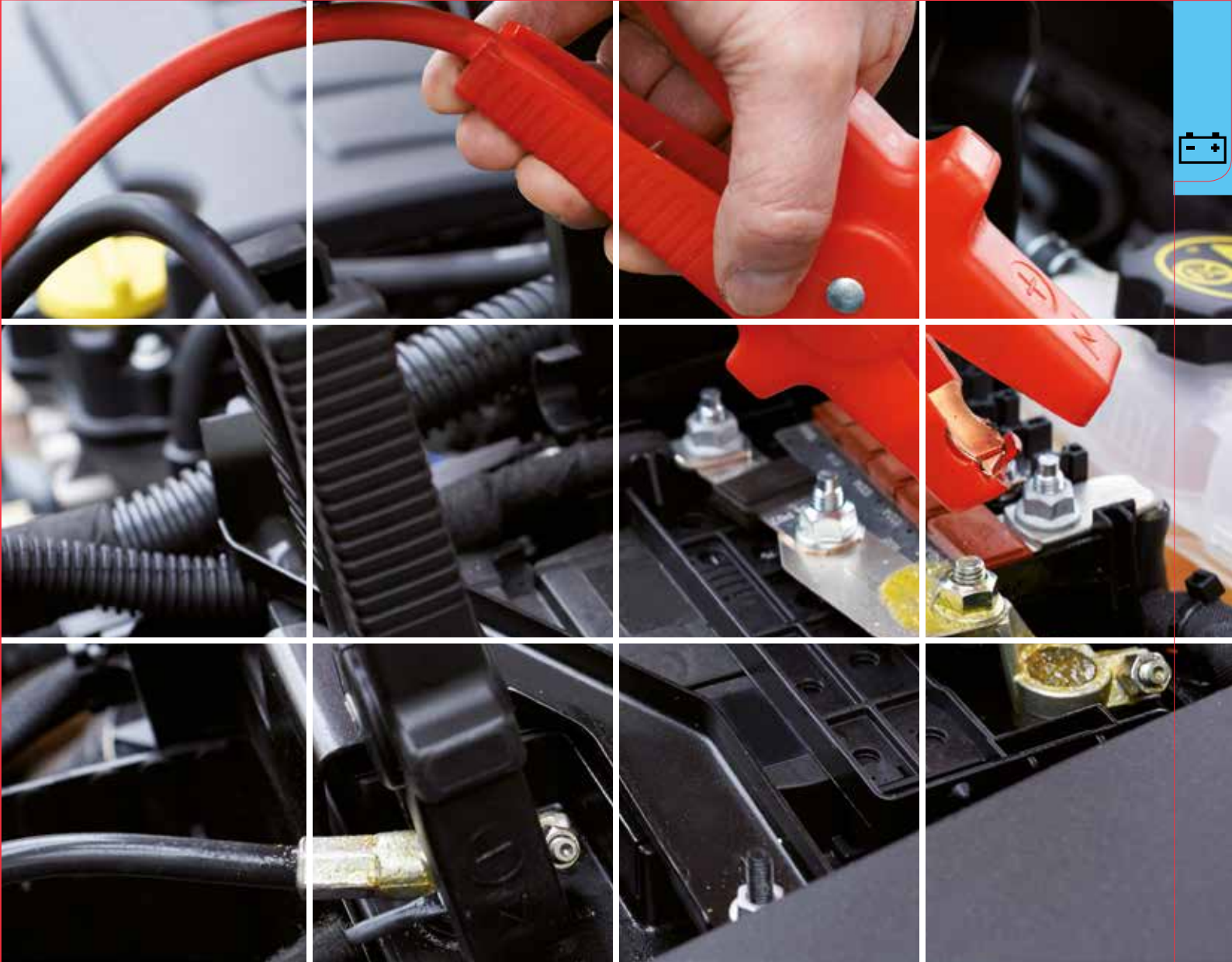

BATTERIE

BATTERIES

BATTERIE GOODYEAR pag 22
 BATTERIE XTRA pag 25



POWER HOUSE 330A [EN] - 40AH

77501

- BATTERIA 12V - 40AH
- BATTERY 12V - 40AH
- BATTERIE 12V - 40AH
- Batterie 12V - 40AH
- BATERÍA 12V - 40AH

START CURRENT:	330A [EN]
MISURE/SIZE:	207x175x175MM
TERMINALI/TERMINALS:	STANDARD
POLO/POLE:	+ DESTRO/RIGHT



POWER HOUSE 370A [EN] - 45AH

77504

- BATTERIA 12V - 45AH
- BATTERY 12V - 45AH
- BATTERIE 12V - 45AH
- Batterie 12V - 45AH
- BATERÍA 12V - 45AH

START CURRENT:	370A [EN]
MISURE/SIZE:	207x175x175MM
TERMINALI/TERMINALS:	STANDARD
POLO/POLE:	+ DESTRO/RIGHT

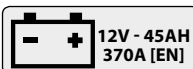

POWER HOUSE 390A [EN] - 50AH

77507

- BATTERIA 12V - 50AH
- BATTERY 12V - 50AH
- BATTERIE 12V - 50AH
- Batterie 12V - 50AH
- BATERÍA 12V - 50AH

START CURRENT:	390A [EN]
MISURE/SIZE:	207x175x175MM
TERMINALI/TERMINALS:	STANDARD
POLO/POLE:	+ DESTRO/RIGHT

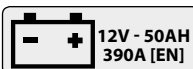



POWER HOUSE 450A [EN] - 55AH

77510

- BATTERIA 12V - 55AH
- BATTERY 12V - 55AH
- BATTERIE 12V - 55AH
- Batterie 12V - 55AH
- BATERÍA 12V - 55AH

START CURRENT:	450A [EN]
MISURE/SIZE:	242x175x190MM
TERMINALI/TERMINALS:	STANDARD
POLO/POLE:	+ DESTRO/RIGHT



POWER HOUSE 510A [EN] - 60AH

77513

- BATTERIA 12V - 60AH
- BATTERY 12V - 60AH
- BATTERIE 12V - 60AH
- Batterie 12V - 60AH
- BATERÍA 12V - 60AH

START CURRENT:	510A [EN]
MISURE/SIZE:	242x175x190MM
TERMINALI/TERMINALS:	STANDARD
POLO/POLE:	+ DESTRO/RIGHT

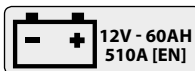

POWER HOUSE 650A [EN] - 70AH

77516

- BATTERIA 12V - 70AH
- BATTERY 12V - 70AH
- BATTERIE 12V - 70AH
- Batterie 12V - 70AH
- BATERÍA 12V - 70AH

START CURRENT:	650A [EN]
MISURE/SIZE:	276x175x190MM
TERMINALI/TERMINALS:	STANDARD
POLO/POLE:	+ DESTRO/RIGHT

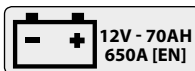

POWER HOUSE 710A [EN] - 80AH

77519

- BATTERIA 12V - 80AH
- BATTERY 12V - 80AH
- BATTERIE 12V - 80AH
- Batterie 12V - 80AH
- BATERÍA 12V - 80AH

START CURRENT:	710A [EN]
MISURE/SIZE:	276x175x190MM
TERMINALI/TERMINALS:	STANDARD
POLO/POLE:	+ DESTRO/RIGHT

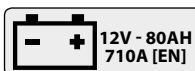

POWER HOUSE 780A [EN] - 90AH

77522

- BATTERIA 12V - 90AH
- BATTERY 12V - 90AH
- BATTERIE 12V - 90AH
- Batterie 12V - 90AH
- BATERÍA 12V - 90AH

START CURRENT:	780A [EN]
MISURE/SIZE:	353x175x190MM
TERMINALI/TERMINALS:	STANDARD
POLO/POLE:	+ DESTRO/RIGHT

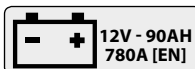

POWER HOUSE 770A [EN] - 100AH

77525

- BATTERIA 12V - 100AH
- BATTERY 12V - 100AH
- BATTERIE 12V - 100AH
- Batterie 12V - 100AH
- BATERÍA 12V - 100AH

START CURRENT:	770A [EN]
MISURE/SIZE:	353x175x190MM
TERMINALI/TERMINALS:	STANDARD
POLO/POLE:	+ DESTRO/RIGHT

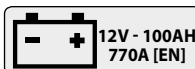



XPOWER5 300A [EN] - 40AH

55101

- BATTERIA 12V - 40AH
- BATTERY 12V - 40AH
- BATTERIE 12V - 40AH
- Batterie 12V - 40AH
- BATERÍA 12V - 40AH

START CURRENT:	300A [EN]
MISURE/SIZE:	207x175x175MM
TERMINALI/TERMINALS:	STANDARD
POLO/POLE:	+ DESTRO/RIGHT

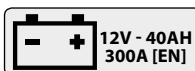

XPOWER5 340A [EN] - 45AH

55104

- BATTERIA 12V - 45AH
- BATTERY 12V - 45AH
- BATTERIE 12V - 45AH
- Batterie 12V - 45AH
- BATERÍA 12V - 45AH

START CURRENT:	340A [EN]
MISURE/SIZE:	207x175x175MM
TERMINALI/TERMINALS:	STANDARD
POLO/POLE:	+ DESTRO/RIGHT

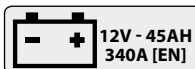

XPOWER5 360A [EN] - 50AH

55107

- BATTERIA 12V - 50AH
- BATTERY 12V - 50AH
- BATTERIE 12V - 50AH
- Batterie 12V - 50AH
- BATERÍA 12V - 50AH

START CURRENT:	360A [EN]
MISURE/SIZE:	207x175x175MM
TERMINALI/TERMINALS:	STANDARD
POLO/POLE:	+ DESTRO/RIGHT



XPOWER5 420A [EN] - 55AH

55110

- BATTERIA 12V - 55AH
- BATTERY 12V - 55AH
- BATTERIE 12V - 55AH
- Batterie 12V - 55AH
- BATERÍA 12V - 55AH

START CURRENT:	420A [EN]
MISURE/SIZE:	242x175x190MM
TERMINALI/TERMINALS:	STANDARD
POLO/POLE:	+ DESTRO/RIGHT

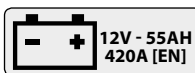

XPOWER5 480A [EN] - 60AH

55113

- BATTERIA 12V - 60AH
- BATTERY 12V - 60AH
- BATTERIE 12V - 60AH
- Batterie 12V - 60AH
- BATERÍA 12V - 60AH

START CURRENT:	480A [EN]
MISURE/SIZE:	242x175x190MM
TERMINALI/TERMINALS:	STANDARD
POLO/POLE:	+ DESTRO/RIGHT

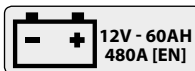

XPOWER5 620A [EN] - 70AH

55116

- BATTERIA 12V - 70AH
- BATTERY 12V - 70AH
- BATTERIE 12V - 70AH
- Batterie 12V - 70AH
- BATERÍA 12V - 70AH

START CURRENT:	620A [EN]
MISURE/SIZE:	276x175x190MM
TERMINALI/TERMINALS:	STANDARD
POLO/POLE:	+ DESTRO/RIGHT

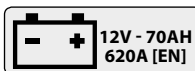



XPOWER5 680A [EN] - 80AH

55119

- BATTERIA 12V - 80AH
- BATTERY 12V - 80AH
- BATTERIE 12V - 80AH
- Batterie 12V - 80AH
- BATERÍA 12V - 80AH

START CURRENT:	680A [EN]
MISURE/SIZE:	276x175x190MM
TERMINALI/TERMINALS:	STANDARD
POLO/POLE:	+ DESTRO/RIGHT

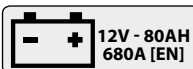

XPOWER5 750A [EN] - 90AH

55122

- BATTERIA 12V - 90AH
- BATTERY 12V - 90AH
- BATTERIE 12V - 90AH
- Batterie 12V - 90AH
- BATERÍA 12V - 90AH

START CURRENT:	7500A [EN]
MISURE/SIZE:	353x175x190MM
TERMINALI/TERMINALS:	STANDARD
POLO/POLE:	+ DESTRO/RIGHT

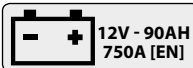

XPOWER5 740A [EN] - 100AH

55125

- BATTERIA 12V - 100AH
- BATTERY 12V - 100AH
- BATTERIE 12V - 100AH
- Batterie 12V - 100AH
- BATERÍA 12V - 100AH

START CURRENT:	740A [EN]
MISURE/SIZE:	353x175x190MM
TERMINALI/TERMINALS:	STANDARD
POLO/POLE:	+ DESTRO/RIGHT

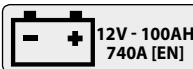



PULIZIA PROTEZIONE & LINEA PET

CLEANING PROTECTION AND PET LINE

SUPPORTO VENDITA PULIZIA E PROTEZIONE



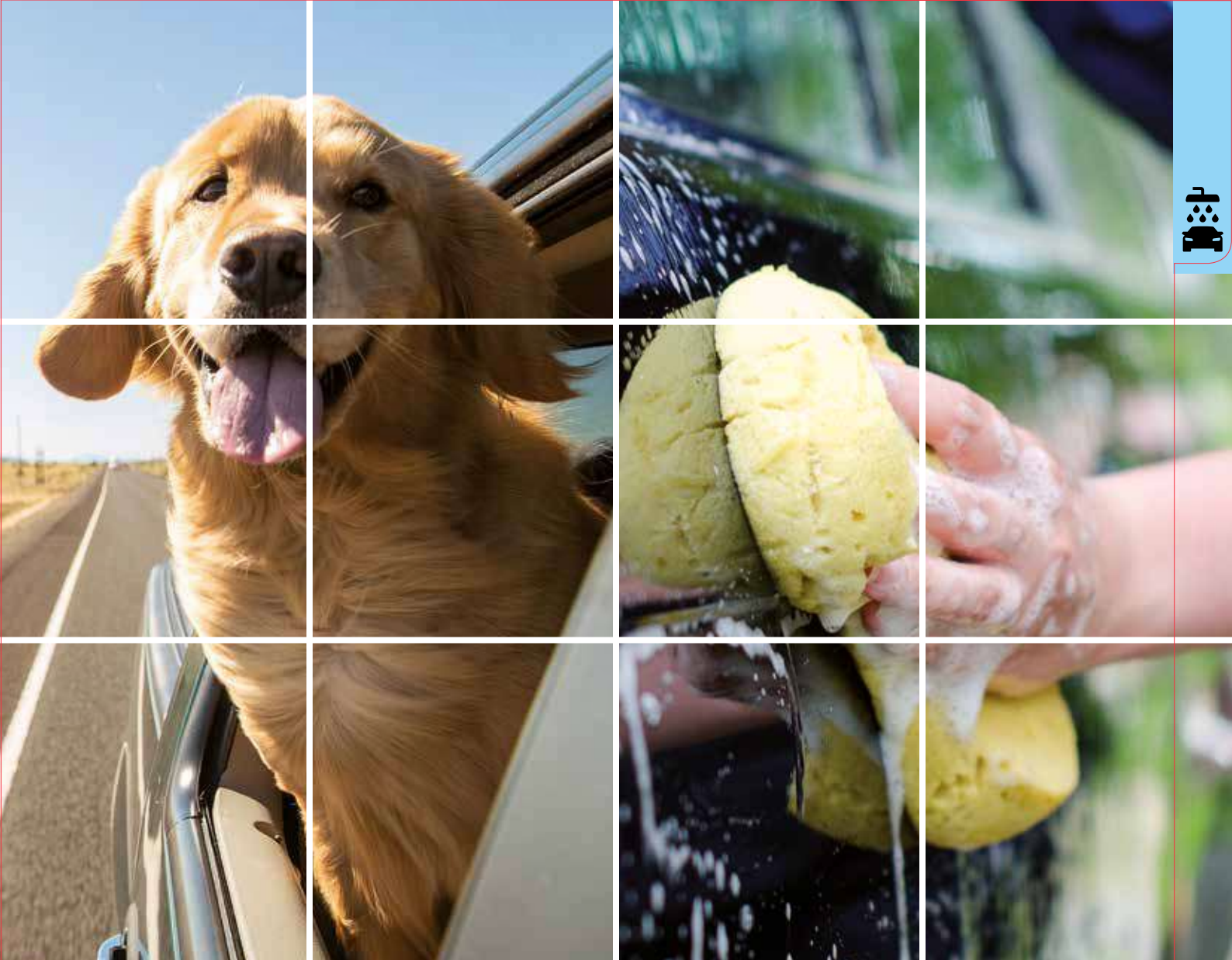

PULIZIA PROTEZIONE & LINEA PET

CLEANING PROTECTION AND PET LINE

LINEA PET	pag 30
CHIMICO GOODYEAR	pag 36
CHIMICO GULF	pag 58
CHIMICO BOTTARI	pag 61
ACCESSORI PULIZIA E PROTEZIONE	pag 70



PROTEGGI SEDILE ANTERIORE



77480

- PROTEGGI SEDILE ANTERIORE
- CAPA DE ASSENTO
- PROTECTION DE SIÈGE AVANT
- Schutzhülle
- FUNDA DE ASIENTO



LAVABILE E RESISTENTE



MASTER 24 INNER 6

PROTEGGI SEDILI POSTERIORI

77481

- PROTEGGI SEDILI POSTERIORI
- REAR SEAT PROTECTOR
- PROTECTION DE SIÈGE
- Schutzhülle
- PROTECCIÓN ASIENTO



**CON GANCI
DI FISSAGGIO
140x145CM**



MASTER 12 INNER 6

PROTEGGI VANO DI CARICO



77482

- PROTEGGI VANO DI CARICO
- PROTECT LOADING COMPARTMENT
- PROTÉGER LE COMPARTIMENT DE CHARGEMENT
- Füllfach Schützen
- PROTEGER EL COMPARTIMIENTO DE CARGA

**LAVABILE
E IMPERMEABILE**



**3 PEZZI
SEPARATI
CHE SI ADATTANO
A TUTTI I TIPI DI BAULE**



MASTER 12 INNER 6

BORSA TRASPORTINO

77483

- BORSA TRASPORTINO **SALVASPAZIO**
- TRANSPORT BAG
- SAC DE TRANSPORT
- Tragetasche
- BOLSA DE TRANSPORTE

GOODYEAR



IDEALE PER IL TRASPORTO DI GATTI E CANI DI PICCOLA TAGLIA.
APERTURE LATERALI E FRONTALI PER RENDERE SEMPLICE L'INGRESSO DEL VOSTRO ANIMALE.
OTTIMA VENTILAZIONE CHE RENDE SICURO IL TRASPORTO.

MASTER 8 INNER 4

SEPARA SEDILE E ORGANIZER

77484

- SEPARA SEDILE E ORGANIZER
- SEPARA SEAT AND ORGANIZER
- SEPARA SEAT ET ORGANISATEUR
- Separa Sitz und Organizer
- ASIENTO SEPARA Y ORGANIZADOR



GOODYEAR



MASTER 12 INNER 6

RETE DI PROTEZIONE E DI SEPARAZIONE

77485

- RETE DI PROTEZIONE E DI SEPARAZIONE
- PROTECTION AND SEPARATION NETWORK
- RÉSEAU DE PROTECTION ET DE SÉPARATION
- Schutz- und Trennungnetz
- RED DE PROTECCIÓN Y SEPARACIÓN

GOODYEAR

CON GANCI DI FISSAGGIO

90x70CM

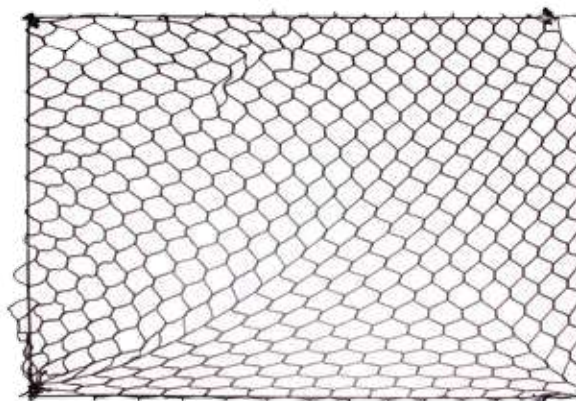

MASTER 24 INNER 12

GRIGLIA PER VENTILAZIONE FINESTRINO E SICUREZZA



77486

- GRIGLIA PER VENTILAZIONE FINESTRINO E SICUREZZA
- WINDOW GRILLE FOR SECURITY AND VENTILATION
- GRILLE DE SÉCURITÉ ET DE VENTILATION
- Schutz-und Lüftungsgitter
- REJA DE SEGURIDAD Y DE VENTILACIÓN

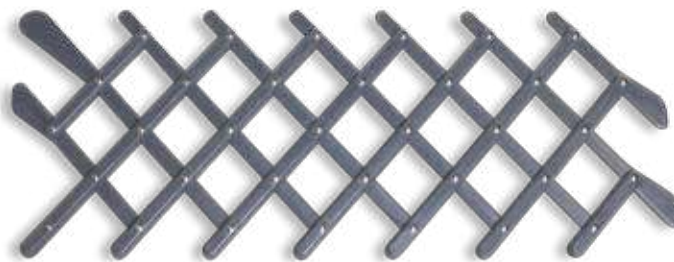

SALVASPAZIO



MASTER 48 INNER 12

PRATICA E REGOLABILE È L'IDEALE PER AREARE L'ABITACOLO DELL'AUTOMOBILE IN TUTTA SICUREZZA

SET BORSA PER CIBO E CIOTOLA IMPERMEABILE



77487

- SET BORSA PER CIBO E CIOTOLA IMPERMEABILE
- BAG SET FOR FOOD AND WATERPROOF BOWL
- SAC ENSEMBLE POUR BOL ALIMENTAIRE ET ETANCHE
- Tasche für Lebensmittel und Wasserdicht Schüssel
- BOLSO FIJADO PARA ALIMENTOS E IMPERMEABILIZANTES

IMPERMEABILE



**IDEALE ANCHE PER
CONTENERE ACQUA**

SALVASPAZIO

**CONTIENE FINO A
4 KG DI CIBO**



MASTER 12 INNER 6

SPAZZOLA IN GOMMA SPECIALE TOGLI PELI



77488

- SPAZZOLA IN GOMMA
- RUBBER BRUSH
- BROSE EN CAOUTCHOUC
- Gummibürste
- CEPILLO DE GOMA



MASTER 48 INNER 12

SPAZZOLA IN GOMMA PER RIMUOVERE I PELI DI ANIMALI DAI TESSUTI, PARTICOLARMENTE INDICATA PER SEDILI, TAPPETI E TAPPEZZERIA AUTOMOBILE. RIMUOVE I PELI IN MODO SEMPLICE E VELOCE.

RULLO ADESIVO RIMUOVI PELI E IMPURITÀ

77489

- RULLO ADESIVO RIMUOVI PELI E IMPURITÀ
- LINT ROLLER
- ROULEAU RAMASSE POILS
- Fusselroller
- RODILLIO QUINTA-PELUSAS



PACK



**BASTA LAVARLO CON ACQUA E
RITORNA SUBITO ADERENTE E
PRONTO ALL'USO**

MASTER 48 INNER 12

GOODYEAR

GUINZAGLIO CON CONNETTORE CINTURA DI SICUREZZA

77490

- GUINZAGLIO PER PASSEGGIO E CON CONNETTORE CINTURA DI SICUREZZA
- LEASH FOR WALKING AND WITH SAFETY BELT CONNECTOR
- LAISSE POUR MARCHER ET AVEC CONNECTEUR DE CEINTURE DE SÉCURITÉ
- Leine zum Gehen und mit Sicherheitsgurtverbinder
- CORREA PARA CAMINAR Y CON CONECTOR DE CORREA DE SEGURIDAD



MASTER 24 INNER 12

GOODYEAR

CONNETTORE CINTURA DI SICUREZZA

77491

- CONNETTORE CINTURA DI SICUREZZA REGOLABILE PER COLLARE
- ADJUSTABLE SAFETY BELT CONNECTOR FOR COLLAR
- CONNECTEUR DE CEINTURE DE SÉCURITÉ RÉGLABLE POUR COL
- Einstellbarer Sicherheitsgurtverbinder für Kragen
- CONECTOR DE CORREA DE SEGURIDAD AJUSTABLE PARA COLLAR



MASTER 48 INNER 12

SI PUÒ AGGANCIARE A QUALSIASI COLLARE O PETTORINA

GOODYEAR

RETE SEPARAZIONE

77498

- TRASPORTO ANIMALI E MERCE
- DOG AND GOODS CARGO GUARD
- FILET POUR LE TRASPORTE DES ANIMAUX ET MERCHANDISE UNIVERSELLE
- Universalnetz für den Transport von Tieren und Waren
- RED PARA EL TRASPORTE DE ANIMALES Y MERCANCIA UNIVERSAL

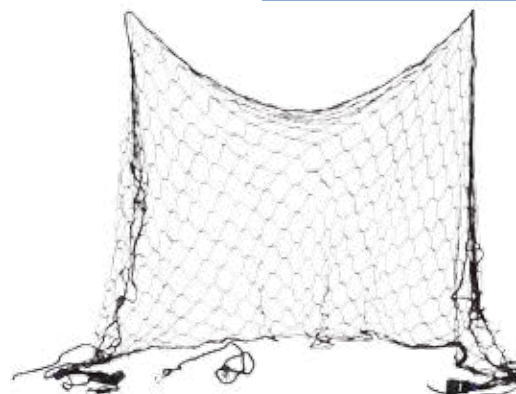

MASTER 24 INNER 12

77498

150 x 60 cm

GOODYEAR

GRIGLIA SICUREZZA

77499

77499

2 elementi

- GRIGLIA DI SEPARAZIONE, TRASPORTO ANIMALI E MERCE
- UNIVERSAL DOG AND GOODS CARGO GUARD
- GRILLE POUR LE TRASPORT DES ANIMAUX ET MARCHANDISE
- Universal Trenngitter für den Transport von Tieren und Waren
- SEPARADOR PARA EL TRANSPORTE DE ANIMALES Y MERCANCIA

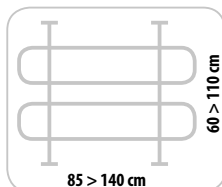

MASTER 6

2 ELEMENTI

REGOLABILE
ADJUSTABLE

GOODYEAR



GRIGLIA SICUREZZA

77500

77500

3 elementi

- GRIGLIA DI SEPARAZIONE, TRASPORTO ANIMALI E MERCE
- UNIVERSAL DOG AND GOODS CARGO GUARD
- GRILLE POUR LE TRASPORT DES ANIMAUX ET MARCHANDISE
- Universal Trenngitter für den Transport von Tieren und Waren
- SEPARADOR PARA EL TRANSPORTE DE ANIMALES Y MERCANCIA

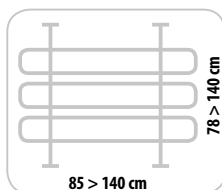

MASTER 6

3 ELEMENTI

REGOLABILE
ADJUSTABLE

GOODYEAR

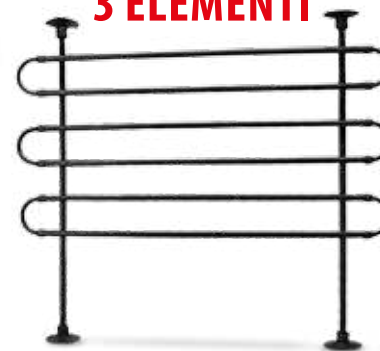

PULITORE TESSUTI E MOQUETTE INTERNO AUTO

77492

- PULITORE PER TESSUTI E MOQUETTE DI INTERNI AUTO 750 ml
- CLEANER FOR CAR UPHOLSTERY AND CARPETS 750 ML
- NETTOYANT POUR TISSUS DE VOITURE ET CARPETING 750 ml
- Reiniger für Car Tissues und Teppich 750 ml
- LIMPIADOR PARA TEJIDOS DE COCHE Y ALFOMBRAS 750 ml



MASTER 12

INDICATO PER LA PULIZIA DI
MOQUETTE E TESSUTI



GOODYEAR



PULITORE PER PELLE AUTO

77493

- PULITORE PER INTERNI AUTO IN PELLE E SIMIL PELLE 750 ml
- LEATHER CLEANER FOR CAR 750 ml
- NETTOYANT AUTO AUTO CUIR 750 ml
- Leder-Reiniger für Auto 750 ml
- LIMPIADOR DE CUERO PARA COCHE 750 ml



MASTER 12

INDICATO PER LA PULIZIA DI
QUALSIASI TIPO DI PELLE



GOODYEAR



PULITORE PLASTICHE AUTO

77494

- PULITORE PLASTICHE AUTO 750 ml
- PLASTIC CLEANER FOR CAR 750 ml
- NETTOYANT PLASTIQUE POUR VOITURE 750 ml
- Kunststoffreiniger für Auto 750 ml
- NETTOYANT PLASTIQUE POUR VOITURE 750 ml



MASTER 12

INDICATO PER TUTTI I TIPI
DI PLASTICHE
EFFETTO ANTISTATICO CONTRO IL
DEPOSITO DI PELO DI ANIMALI



GOODYEAR



SGRASSATORE TRASPORTINI E GABBIE DA VIAGGIO

77495

- SGRASSATORE TRASPORTINI E GABBIE DA VIAGGIO 750 ml
- DEGREASER FOR CAGES 750 ML
- DÉGRAISSANT POUR CAGES 750 ml
- Entgaser für Cages 750 ml
- DESENGRASANTE PARA JAULAS 750 ml



MASTER 12

INDICATO PER LA PULIZIA
PROFONDA DI TRASPORTINI,
LETTIERE E TELI BAGAGLIAIO

GOODYEAR



RIMUOVI ODORI

77496

- RIMUOVI ODORI 750 ml
- ODOR ELIMINATOR 750 ML
- ELIMINATEUR D'ODEUR 750 ml
- Geruchseliminator 750 ml
- ELIMINADOR DE OLOR 750 ml



MASTER 12

ELIMINA I CATTIVI ODORI
DEGLI ANIMALI LASCIANDO UN
GRADEVOLE PROFUMO



GOODYEAR



ALLONTANA CANI E GATTI

77497

- ALLONTANA CANI E GATTI / DISABITUANTE 750 ml
- DOGS AND CATS DISSUADER / DISABLING 750 ML
- DISSUADER CHIEN ET CHAT / DÉACTIVANT 750 ml
- Hunde und Katzen Dissuader / Disable 750 ml
- PERROS Y GATOS DISSUADER / DISABLING 750 ml



MASTER 12

DISSUASORE CANI E GATTI PER
ALLONTANARLI DA RUOTE,
TAPPETI, PAVIMENTI, VASI E PER
TUTTE LE ZONE DOVE NON SONO
DESIDERATI.
COMPLETAMENTE INNOCUO
PER LA SALUTE

GOODYEAR



DETERGENTE TESSUTI E MOQUETTE

77801

- DETERGENTE TESSUTI E MOQUETTE
- UPHOLSTERY AND MOQUETTE MATS DETERGENT
- REMBOURRAGE ET MOQUETTE TAPIS DÉTERGENT
- Polster und Moquette Mats Waschmittel
- TAPICERÍA Y ALFOMBRILLAS DETERGENTE MOQUETTE



- Elimina le macchie
- Non lascia aloni
- Profumo di nuovo
- Protegge
- Anti Allergenico

750 ml

MASTER 12



Applicare il prodotto sulla parte da trattare, lasciare agire alcuni istanti, spugnare e successivamente aspirare o spazzolare. In caso di contatto con gli occhi e la pelle lavare abbondantemente con acqua.

Apply the product on the areas to be cleaned, let it work a little while before sponging, and then vacuum clean or brush off. In case of accidental contact with skin or eyes wash with soap or water.



DETERGENTE TESSUTI E MOQUETTE

77852-650ml

- DETERGENTE TESSUTI E MOQUETTE
- UPHOLSTERY AND MOQUETTE MATS DETERGENT
- REMBOURRAGE ET MOQUETTE TAPIS DÉTERGENT
- Polster und Moquette Mats Waschmittel
- TAPICERÍA Y ALFOMBRILLAS DETERGENTE MOQUETTE

650 ml

MASTER 24



Schiuma attiva per eliminare lo sporco da sedili, superfici in tessuto e rivestimenti in moquette. Non bagna e si rimuove facilmente, lasciando un gradevole profumo. Ravviva i colori e non necessita risciacquo.

Active foam for eliminating dirt from fabric car seats and surfaces as well as carpeted coverings. Does not wet fabrics and it is simple to remove, leaving a pleasant perfume. Revives colours and does not require rinsing.



CON SPAZZOLA

DETERGENTE VETRI

77802

- DETERGENTE VETRI
- GLASS DETERGENT
- DÉTERGENT POUR VITRES
- Reinigungsmittel für Glas
- DETERGENTE PARA VIDRIOSE



- Pulisce
- Rimuove gli insetti
- Sgrassa
- Alto Scorrimento Spazzole
- Anti ghiaccio

750 ml

MASTER 12



Pulisce a fondo vetri e cristalli senza lasciare aloni. Rende la superficie brillante e profumata.

Thoroughly cleans glass and windows without leaving streaks. Leaves the surface bright and lint free.



DETERGENTE UNIVERSALE

77803

- DETERGENTE UNIVERSALE
- UNIVERSAL CLEANER
- NETTOYANT TOUT USAGE
- Universalreiniger
- UNIVERSAL DE DETERGENTE



- Pulisce
- Antistatico
- Sgrassa
- Perfetto su tutti i materiali
- Protegge

750 ml

MASTER 12



Pulisce a fondo gli interni della vostra vettura senza lasciare aloni. Rende la superficie brillante e profumata.

Thoroughly cleans your car interiors without leaving streaks. Leaves the surface bright and lint free.





TRATTAMENTO PELLE

77805

- TRATTAMENTO PELLE
- LEATHER CARE
- NOURRISSANT POUR LA PEAU
- Hautpflegecreme
- NUTRIENTE CUERO



Nutre

Pulisce

Rinnova

Protegge

750 ml



MASTER 12



Pulisce e protegge tutti i tipi di pelle conferendo morbidezza ed elasticità. Previene l'invecchiamento della pelle ridonandole tono e lucentezza. Gradevolmente profumato.

Cleans and protects all types of leather, brings back original softness and elasticity. Anti-aging, reinforces the leather and brings back a pristine shine. Pleasantly scented.



CERA LIQUIDA AUTO

77806

- CERA LIQUIDA AUTO
- CAR BODY POLISH
- PRODUIT CIRANT POUR CARROSSERIE
- Poliermittel für die Karosserie
- ABRILLANTADOR DE CARROCEÍAS



Lucida

Rapido

Rinnova

Protegge

750 ml



MASTER 12



Ridona brillantezza a tutte le superfici verniciate di auto e moto. Non contiene abrasivi.

Restores the shiny surface of the painted areas of all vehicles. It doesn't contain abrasives.



CERA LUCIDANTE PROTETTIVA

77816

- CERA LUCIDANTE PROTETTIVA
- UNIVERSAL PROTECTIVE SHINING WAX
- EAU POLONAISE
- Polish Water
- AGUA POLACA

250 ml



MASTER 24



Cera lucidante e protettiva per carrozzeria. Oltre a rendere la verniciatura particolarmente brillante e senza aloni, crea una sottile barriera che protegge dalle intemperie, dai raggi UV, dall'inquinamento e dallo sporco. Resiste a numerosi lavaggi. Utilizzare il prodotto su carrozzeria non surriscaldata e non esposta ai raggi del sole.

Polishing and protective car body wax. It gives a new brightness to the carbody, without marks, and at the same time creates a thin and long lasting film, protecting against elements, dirt, UV rays and pollution. It stands frequent washings. Do not use the product on a warm body or under the direct sun rays.

CERA SPRAY PROTETTIVA

77861

- CERA SPRAY PROTETTIVA
- PROFESSIONAL CAR BODY POLISH
- EAU DE SPRAY
- Spray Water
- AGUA DE PULVERIZACION



Lucida

Deterge

Rinnova

Protegge

600 ml



MASTER 12



Ridona brillantezza a tutte le superfici verniciate di auto e moto. Non contiene abrasivi.

Restores the shiny surface of the painted areas of cars and motorcycles. It doesn't contain abrasives.

CERA POLISH LUCIDANTE

77862

- CERA POLISH LUCIDANTE
- PROFESSIONAL CAR WAY POLISH
- EAU POLONAISE
- Polish Water
- AGUA POLACA



Protegge Lucida
Deterge Rapido
Rinnova

600 ml

MASTER 12



Ridona brillantezza a tutte le superfici verniciate di auto e moto. Non contiene abrasivi.

Restores the shiny surface of the painted areas of cars and motorcycles. It doesn't contain abrasives.

SHAMPOO AUTO

77807

- SHAMPOO AUTO
- SHAMPOO CAR
- SHAMPOO VOITURE
- Autoshampoo
- CHAMPÙ DE COCHES



Sgrassa Antistatico
Deterge Concentrato
Protegge

1 Litro

MASTER 12



La sua formula innovativa deterge e ravviva la superficie della vostra auto lasciandola splendente e senza aloni. Indicato per lavaggi frequenti.

The new special formula cleans and renews the body of your car, giving a shiny finish without marks. Suitable for frequent washings.



SHAMPOO AUTO

77818

- SHAMPOO AUTO
- SHAMPOO CAR
- SHAMPOO VOITURE
- Autoshampoo
- CHAMPÙ DE COCHES



Sgrassa Antistatico
Deterge Concentrato
Protegge

5 Litri

MASTER 4



La sua formula innovativa deterge e ravviva la superficie della vostra auto lasciandola splendente e senza aloni. Indicato per lavaggi frequenti.

The new special formula cleans and renews the body of your car, giving a shiny finish without marks. Suitable for frequent washings.

SHAMPOO & CERA

77808

- SHAMPOO & CERA
- SHAMPOO AND CAR WAX
- SHAMPOO ET VOITURE LUSTRE
- SHAMPOO UND AUTOWACHS
- SHAMPOO Y CERA LIMPIA COCHE



Lucida Protegge
Sgrassa Antistatico
Deterge

1 Litro

MASTER 12



Shampoo auto lucidante consigliato per il lavaggio frequente dell'auto. Con un'unica operazione deterge a fondo, ravviva la carrozzeria e stende una sottile pellicola lucida di cera che protegge nel tempo la vernice della vostra auto.

Polishing Shampoo perfect for frequent washings. In just one product You will have a perfect cleaning, a brighten body and a thin and long lasting paint protective wax layer.





2 IN 1 LUCIDA E PROTEGGE

77863

- 2 IN 1 LUCIDA E PROTEGGE
- PROFESSIONAL 2 IN 1
- 2 EN 1 POLONAISE ET PROTECTEUR
- 2 in 1 Polish und Schutz
- 2 EN 1 LUSTROS Y PROTECTORES



Lucida
Protegge

600 ml

MASTER 12



Ridona brillantezza a tutte le **superfici verniciate** di auto e moto. Non contiene abrasivi.

Restores the shiny surface of the painted areas of cars and motorcycles. It doesn't contain abrasives.

5 IN 1 LUCIDA E PROTEGGE

77864

- 5 IN 1 LUCIDA E PROTEGGE
- PROFESSIONAL 5 IN 1
- 5 EN 1 POLISH ET PROTECTEUR
- 5 in 1 Polish und Schutz
- 5 EN 1 LUSTROS Y PROTECTORES



Elimina resina Elimina il grasso e l'olio
Elimina catrame Lucida le cromature
Elimina i graffi

600 ml

MASTER 12



Ridona brillantezza a tutte le superfici verniciate di auto e moto. Non contiene abrasivi.

Restores the shiny surface of the painted areas of cars and motorcycles. It doesn't contain abrasives.



LUCIDA E RINNOVA CRUSCOTTI

77804-77820-77821-77822

- LUCIDA E RINNOVA CRUSCOTTI
- DASHBOARD BRIGHTENER
- SHINY ET NOUVEAU TABLEAU DE BORD
- Glänzende und neue Instrumententafel
- BRILLANTE Y NUEVO PANEL DE INSTRUMENTOS



Lucida Non unge
Pulisce Antistatico
Anti UV

750 ml

MASTER 12



Prodotto a doppia azione, ravviva e deodora l'interno dell'auto. Grazie ai suoi speciali componenti senza solventi è ideale per lucidare tutte le superfici in plastica della vostra auto. Può essere utilizzato per mantenere lucide valigie, caschi ecc...

A double action product that brightens and perfumes your car's interior. Thanks to the special no-chem formula, it is suitable for all the plastic parts of the car. Also perfect for suitcases, etc helmets,...



77804 LAVANDA

77820 PINO

77821 VANIGLIA

77822 LIMONE

LUCIDA E RINNOVA CRUSCOTTI

77834

- LUCIDA E RINNOVA CRUSCOTTI
- DASHBOARD BRIGHTENER
- SHINY ET NOUVEAU TABLEAU DE BORD
- Glänzende und neue Instrumententafel
- BRILLANTE Y NUEVO PANEL DE INSTRUMENTOS



Lucida Non unge
Pulisce Antistatico
Anti UV

450 ml

MASTER 24



Studiato per rinnovare i cruscotti e tutte le parti in plastica dell'auto. Lucidando forma uno strato protettivo sulle parti trattate ripristinando l'aspetto originale e mantenendole a lungo pulite e brillanti. Forte effetto antistatico.

Designed to renew the look of dashboards and all plastic car parts. When polishing, the product leaves a protective layer, restoring the original appearance while keeping the plastic clean and shinier for longer. Efficient anti-static effect.



77834 PINO

77834 LIMONE

77834 VANIGLIA

77834 OCEANO

LUCIDA E RINNOVA CRUSCOTTI

77836

- LUCIDA E RINNOVA CRUSCOTTI
- DASHBOARD BRIGHTENER
- SHINY ET NOUVEAU TABLEAU DE BORD
- Glänzende und neue Instrumententafel
- BRILLANTE Y NUEVO PANEL DE INSTRUMENTOS

Studiato per rinnovare i cruscotti e tutte le parti in plastica dell'auto. Lucidando forma uno strato protettivo sulle parti trattate ripristinando l'aspetto originale e mantenendole a lungo pulite e brillanti. Forte effetto antistatico.

Designed to renew the look of dashboards and all plastic car parts. When polishing, the product leaves a protective layer, restoring the original appearance while keeping the plastic clean and shinier for longer. Efficient anti-static effect.



250 ml

MASTER 30

Lucida Non unge
Pulisce Antistatico
Anti UV



77836 ROSA

77836 FRAGOLA

77836 PINO

77836 LIMONE

77836 VANIGLIA

77836 OCEANO

LUCIDA CRUSCOTTI EFFETTO LUCIDO

77892

- LUCIDA CRUSCOTTI EFFETTO LUCIDO
- PROFESSIONAL DASHBOARD POLISHER
- POLISSEUR TABLEAUX DE BORDS
- Cockpit-Politur
- LIMPIASALPICADEROS



650 ml

MASTER 24

Lucida Rinnova
Anti UV Protegge
Deterge



Ridona brillantezza a tutte le superfici plastiche di auto e moto. Non contiene abrasivi.

Restores the shiny surface of the plastic areas of cars and motorcycles. It doesn't contain abrasives.



LUCIDA CRUSCOTTI EFFETTO SATINATO

77893

- LUCIDA CRUSCOTTI EFFETTO SATINATO
- PROFESSIONAL SATINATED DASHBOARD POLISHER
- TABLEAU DE BORD MAT
- Nicht glänzend Armaturenbrett Poliermittel
- CUADRO DE MANDO OPACO



650 ml

MASTER 24

Pulisce Non unge
Anti UV Antistatico
Protegge



Ridona brillantezza a tutte le superfici plastiche di auto e moto. Non contiene abrasivi.

Restores the shiny surface of the plastic areas of cars and motorcycles. It doesn't contain abrasives.



SCHIUMA ATTIVA GOMME

77837

- LUCIDA GOMME SCHIUMA ATTIVA
- TYRE SHINE FOAM CLEANER
- NOIR NOUVEAU CAOUTCHOUC
- Schwarz Gummi
- NEGRO CAUCHO NEGRO



650 ml

MASTER 24

Deterge Non unge
Lucida Ravniva
Nutre



LUCIDA GOMME in schiuma è il nuovo e facilissimo prodotto perfetto per prenderti cura delle gomme dei tuoi veicoli. Basta una semplicissima spruzzata sul pneumatico, e la schiuma attiva farà tutto da sola, senza panni, senza rimuovere o stendere il prodotto. LUCIDA GOMME in schiuma non solo ha un effetto detergente che rimuove lo sporco accumulato con il tempo, ma al contempo lascia una pellicola lucida su tutta la superficie, che esalta il profilo del veicolo e protegge la gomma dai raggi UV e dalle intemperie, prevenendone il naturale screpolamento e la decolorazione.

Cleans, shines and protect TIRE SHINE FOAM is the new and easy solution for your vehicles tires care. With just one spray the foam activates immediately, without clothes, without product removal or applying. TIRE SHINE Foam not only has a cleaning power that removes dirt, but also leaves a shiny film on the surface, that enhances the vehicle profile and protects the tire against the UV rays and the elements, preventing discoloration and cracks.



DETERGENTE CERCHI

77854

- DETERGENTE CERCHI IN LEGA/FERRO
- WHEEL DETERGENT
- DÉTERGENT POUR JANTES EN ALLIAGE
- Felgenreiniger für Leichtmetallfelgen
- LIMPIEZA DE LLANTAS

750 ml

MASTER 24



Usato regolarmente, il prodotto Detergente Cerchi rimuove sporco e grasso da tutti i tipi di cerchioni in alluminio, acciaio o plastica, con superfici cromate o lucide, rinnovandole e rendendo la superficie lucente. MODO D'USO: Vaporizzare uniformemente Lucida Cerchioni sulla superficie da trattare o stenderlo con un pennello e lasciare agire senza rimuoverlo. Risciacquare dopo circa 20/30 secondi.

Wheel Detergent removes grease and dirt from all the alloy, steel and plastic wheels, chromed and polished. It perfectly refurbish and polish the surface. USE: Spray evenly Wheel Detergent on the dirt area, or spread it with a brush, and let it dry a little while before removing. Wash it away with water after 20/30 seconds.



NERO GOMME

77855

- DETERGENTE RAVVIVANTE PNEUMATICI
- TYRE SHINE
- RÉNOVATEUR PNEUMATIQUES
- Reifenauffrischer
- NEGRO PARA NEUMÁTICOS

750 ml

MASTER 24



Liquido di altissima qualità che ridona colore e morbidezza ai pneumatici e alle parti in gomma trattate. Resiste nel tempo.

High-quality liquid that restores original colour and softness to tyres and other treated rubber components. Resistant over time.



NERO GOMME CONCENTRATO RAVVIVANTE

77858

- NERO GOMME RAVVIVANTE
- PROFESSIONAL TYRE SHINE
- PNEUS NOIRES
- Schwarze Reifen
- NEUMÁTICOS NEGROS

1 Litro

MASTER 24



Liquido nero di altissima qualità che ridona colore e morbidezza ai pneumatici e alle parti in gomma trattate. Resiste nel tempo. Istruzioni per l'uso. Lavare bene la parte da trattare, spruzzare il prodotto e stenderlo uniformemente con un pennello. Tenere fuori dalla portata dei bambini.

High-quality black liquid that restore original colour and softness to tyres and other treated rubber components. Resistant over time. Keep out of the reach of children. Read the label before use.

Instructions for use. Wash the area to be treated thoroughly; spray on the product, spreading it evenly with a brush.



LAVAVETRI INVERNALE -26°

77819

- LAVAVETRI INVERNALE -26°
- WINTER WINDSCREEN WASHER FLUID -26°
- LIQUIDE PARE-BRISE -26° HIVERNAL
- Flüssigkeit widschutzscheibe -26° winterlich
- LIQUIDO LIMPIA PARABRISAS -26° INVERNAL



Anti aloni Anticongelante
Ugelli puliti Ottima detergenza
Profumato

5 Litri

MASTER 4



Aggiunto alla vaschetta dell'impianto lavavetri abbassa il punto di congelamento dell'acqua nella stagione invernale ne permette il perfetto funzionamento garantendo una perfetta visibilità.

Put it in the windsreen washer tank of your car to lower the water freezing point in the winter season: you will have a perfectly cleaned windscreen.



LIQUIDO DETERGENTE VASCHETTA TERGI

77838

- LIQUIDO DETERGENTE VASCHETTA TERGI
- CITRUS-SCENTED WINDSCREEN WASHER FLUID
- LIQUIDE POUR BAC LAVE-GLACE
- Flüssigkeit für die scheibenwaschanlage
- LIQUIDO LIMPIA CRISTALES

2 Litri

MASTER 8



Liquido detergente per vaschetta tergi vetro aromatizzato al Limone, per una perfetta pulizia di tutti i parabrezza di auto, furgoni e camion.

Citrus-scented windscreen washer fluid.



LIQUIDO DETERGENTE VASCHETTA TERGI

77839

- LIQUIDO DETERGENTE VASCHETTA TERGI
- CITRUS-SCENTED WINDSCREEN WASHER FLUID
- LIQUIDE POUR BAC LAVE-GLACE
- Flüssigkeit für die scheibenwaschanlage
- LIQUIDO LIMPIA CRISTALES

5 Litri

MASTER 4



Liquido detergente per vaschetta tergi vetro aromatizzato al Limone, per una perfetta pulizia di tutti i parabrezza di auto, furgoni e camion.

Citrus-scented windscreen washer fluid.





LIQUIDO LAVAVETRI INVERNALE -40°

77859

- LAVAVETRI INVERNALE -40°C
- WINDSCREEN LIQUID DETERGENT -40°C
- LIQUIDE PARE-BRISE -40° HIVERNAL
- Flüssigkeit Widschutzscheibe -40° Winterlich
- LIQUIDO LIMPIA PARABRISAS -40° INVERNAL

250 ml

MASTER 48



-40°

Aggiunto alla vaschetta dell'impianto lavavetri abbassa il punto di congelamento dell'acqua nella stagione invernale ne permette il perfetto funzionamento garantendo una perfetta visibilità.

Add it in the windscreen fluid tank of the car to reduce the water freezing level during the winter season: it will grant a perfect visibility for greater safety.

LAVAVETRI PLURISTAGIONALE

77860

- LAVAVETRI PLURISTAGIONALE
- WINDSCREEN LIQUID DETERGENT
- LIQUIDE PARE-BRISE
- Flüssigkeit Widschutzscheibe
- LIQUIDO LIMPIA PARABRISAS

250 ml

MASTER 48



Basta versare il liquido nella vaschetta lavavetri e aggiungere 3 lt. d'acqua e la pulizia del parabrezza sarà perfetta. Tenere fuori dalla portata dei bambini. Leggere l'etichetta prima dell'uso.

It is enough to pour it into the glass cleaner tank, add 3 litres water and the windscreen cleaning will be perfect. Keep out of the reach of children. Read the label before use.

LAVAVETRI INVERNALE -26°

77867

- LAVAVETRI INVERNALE -26°
- WINTER WINDSCREEN WASHER FLUID -26°
- LIQUIDE PARE-BRISE -26° HIVERNAL
- Flüssigkeit widschutzscheibe -26° winterlich
- LIQUIDO LIMPIA PARABRISAS -26° INVERNAL

2 Litri

MASTER 6



-26°

Aggiunto alla vaschetta dell'impianto lavavetri abbassa il punto di congelamento dell'acqua nella stagione invernale ne permette il perfetto funzionamento garantendo una perfetta visibilità.

Put it in the windscreen washer tank of your car to lower the water freezing point in the winter season: you will have a perfectly cleaned windscreen.

LAVAVETRI PER VASCHETTA TERGI

77873

- LIQUIDO DETERGENTE VASCHETTA TERGI
- CITRUS-SCENTED WINDSCREEN WASHER FLUID
- LIQUIDE POUR BAC LAVE-GLACE
- Flüssigkeit für die scheibenwaschanlage
- LIQUIDO LIMPIA CRISTALES

CONCENTRATO

100 ml

50 ml x 2 pezzi

MASTER 576
INNER 48



Versare il contenuto del flaconcino direttamente nella vaschetta del tergovetro. Aggiungere acqua a riempimento.

Pour the detergent in the windscreen fluid tank, and fill up with water.



IGIENIZZANTE PER CLIMATIZZATORI

77831

- IGIENIZZANTE PER CLIMATIZZATORI
- HYGIENIZER FOR A/C SYSTEMS
- POUR SYSTÈMES D'AIR CLIMATISÉ
- Klimaanlage-reiniger
- HIGIENIZADOR PARA SISTEMAS DE AIRE ACONDICIONADO

CON CANULA

400 ml

MASTER 12



Elimina i cattivi odori causati da funghi, muffe, batteri e microorganismi dai sistemi di Aria Condizionata. Ideale per impianti automobilistici ed a uso civile. La confezione comprende un tubicino di 60 cm per la distribuzione del prodotto.

It eliminates the smell caused by moulds, bacteria and microorganisms from Air Conditioners. The product is suitable both for automotive and house A/C systems. The package includes a pipe of 60 cms for spreading the product.

SPRAY
a base
Acqua

CLIMA IGIENIZZANTE

77853

- IGIENIZZANTE ANTIODORE PER CONDIZIONATORI D'ARIA
- PERFUMED AIR FRESHENER FOR AIR CONDITIONERS
- AÉROSOL POUR L'ÉLIMINATION DES ODEURS POUR CLIMATISEURS
- Parfümierter Geruchshemmer für Klimaanlagen
- ANTIOLOR PARA CLIMATIZADORES DE AIRE

200 ml

MASTER 24



Elimina i cattivi odori dell'impianto dell'aria condizionata.

Igienizza l'ambiente e profuma l'abitacolo.

Removes the foul smells from the air conditioner. Sanitizes the environment and scents the vehicle interiors.



DEGHIACCIANTE SPRAY

77890

- DEGHIACCIANTE SPRAY
- ICE REMOVER
- DÉCAPANT DE GLACE
- Eisentferner
- REMOVER HIELO

NO GHIACCIO

250 ml

MASTER 24



Elimina all'istante ghiaccio, neve e brina da parabrezza e vetri. Scongela serrature e pinze freni. Non intacca la plastica e le guarnizioni.

Nstantly eliminates ice and frost from windscreens and glass. Defrosts locks, brakes, springs. Does not effect rubber or plastic sealings.



DEGHIACCIANTE SPRAY

77891

- DEGHIACCIANTE SPRAY
- ICE REMOVER
- DÉCAPANT DE GLACE
- Eisentferner
- REMOVER HIELO

NO GHIACCIO

450 ml

MASTER 24



Elimina all'istante ghiaccio, neve e brina da parabrezza e vetri. Scongela serrature e pinze freni. Non intacca la plastica e le guarnizioni.

Nstantly eliminates ice and frost from windscreens and glass. Defrosts locks, brakes, springs. Does not effect rubber or plastic sealings.





LIQUIDO RADIATORI ROSSO -22°

77842

- LIQUIDO ANTICONGELANTE ROSSO RADIATORI
- RED ANTIFREEZE RADIATOR LIQUID
- PRODUIT ANTIGEL PRÉT À L'EMPLOI POUR RADIATEURS
- Gebrauchsfertiges Frostschutzmittel für Kühler
- ANTICONGELANTE PARA RADIADORES, LISTO PARA SU USO

-22°

1 Litro

MASTER 12



Anticongelante per radiatori pronto all'uso, protegge dal gelo l'impianto di raffreddamento dell'auto fino ad una temperatura di -22°C. Contiene particolari inibitori di corrosione ecologici che ne consentono l'impiego anche in presenza di parti in alluminio. Da utilizzarsi anche in estate per aumentare il punto di ebollizione dell'acqua.

Permanent antifreeze liquid, ready for use, ensures protection down to - 22°C. Guarantees total protection of the cooling system of all types of vehicles, including those with engine parts made of aluminium other alloys. The presence of ecological corrosion inhibitors and antifoam agents always guarantees optimum working of the cooling system. May also be used in summer to raise the boiling point of the water.

LIQUIDO RADIATORI BLU -22°

77843

- LIQUIDO ANTICONGELANTE BLU RADIATORI
- BLUE ANTIFREEZE RADIATOR LIQUID
- PRODUIT ANTIGEL PRÉT À L'EMPLOI POUR RADIATEURS
- Gebrauchsfertiges Frostschutzmittel für Kühler
- ANTICONGELANTE PARA RADIADORES, LISTO PARA SU USO

-22°

1 Litro

MASTER 12



Anticongelante per radiatori pronto all'uso, protegge dal gelo l'impianto di raffreddamento dell'auto fino ad una temperatura di -22°C. Contiene particolari inibitori di corrosione ecologici che ne consentono l'impiego anche in presenza di parti in alluminio. Da utilizzarsi anche in estate per aumentare il punto di ebollizione dell'acqua.

Permanent antifreeze liquid, ready for use, ensures protection down to - 22°C. Guarantees total protection of the cooling system of all types of vehicles, including those with engine parts made of aluminium other alloys. The presence of ecological corrosion inhibitors and antifoam agents always guarantees optimum working of the cooling system. May also be used in summer to raise the boiling point of the water.

LIQUIDO RADIATORI ROSSO -22°

77844

- LIQUIDO ANTICONGELANTE ROSSO RADIATORI
- RED ANTIFREEZE RADIATOR LIQUID
- PRODUIT ANTIGEL PRÉT À L'EMPLOI POUR RADIATEURS
- Gebrauchsfertiges Frostschutzmittel für Kühler
- ANTICONGELANTE PARA RADIADORES, LISTO PARA SU USO

-22°

5 Litri

MASTER 4



Anticongelante per radiatori pronto all'uso, protegge dal gelo l'impianto di raffreddamento dell'auto fino ad una temperatura di -22°C. Contiene particolari inibitori di corrosione ecologici che ne consentono l'impiego anche in presenza di parti in alluminio. Da utilizzarsi anche in estate per aumentare il punto di ebollizione dell'acqua.

Permanent antifreeze liquid, ready for use, ensures protection down to - 22°C. Guarantees total protection of the cooling system of all types of vehicles, including those with engine parts made of aluminium other alloys. The presence of ecological corrosion inhibitors and antifoam agents always guarantees optimum working of the cooling system. May also be used in summer to raise the boiling point of the water.

LIQUIDO RADIATORI BLU -22°

77845

- LIQUIDO ANTICONGELANTE BLU RADIATORI
- BLUE ANTIFREEZE RADIATOR LIQUID
- PRODUIT ANTIGEL PRÉT À L'EMPLOI POUR RADIATEURS
- Gebrauchsfertiges Frostschutzmittel für Kühler
- ANTICONGELANTE PARA RADIADORES, LISTO PARA SU USO

-22°

5 Litri

MASTER 4



Anticongelante per radiatori pronto all'uso, protegge dal gelo l'impianto di raffreddamento dell'auto fino ad una temperatura di -22°C. Contiene particolari inibitori di corrosione ecologici che ne consentono l'impiego anche in presenza di parti in alluminio. Da utilizzarsi anche in estate per aumentare il punto di ebollizione dell'acqua.

Permanent antifreeze liquid, ready for use, ensures protection down to - 22°C. Guarantees total protection of the cooling system of all types of vehicles, including those with engine parts made of aluminium other alloys. The presence of ecological corrosion inhibitors and antifoam agents always guarantees optimum working of the cooling system. May also be used in summer to raise the boiling point of the water.

LIQUIDO RADIATORI VIOLA -30°

77846

- LIQUIDO ANTICONGELANTE VIOLA RADIATORI
- PURPLE ANTIFREEZE RADIATOR LIQUID
- PRODUIT ANTIGEL PRÉT À L'EMPLOI POUR RADIATEURS
- Gebrauchsfertiges Frostschutzmittel für Kühler
- ANTICONGELANTE PARA RADIADORES, LISTO PARA SU USO

ACTIVESAFE+



1 Litro

MASTER 12



Liquido per radiatori auto di tipo permanente formulato con inibitori di natura organica. Il prodotto permette in modo particolare la protezione dei componenti in alluminio e in altre leghe leggere, sempre più usati nei motori di ultima generazione. Riduce notevolmente il verificarsi di fenomeni di corrosione e la formazione di incrostazioni. Il prodotto garantisce la protezione dal gelo fino a -30°C e dall'ebollizione estiva con motore funzionante fino a 128°C.

Permanent car radiator fluid formulated with organic inhibitors. The product especially protects those components made of aluminium and other light alloys, found with increasing frequency in the latest generation of motors engines. Significantly reduces corrosion and the formation of scale. It protects down to -30°C and against boiling during the trip in summer condition up to +128°C.

LIQUIDO RADIATORI VERDE -30°

77847

- LIQUIDO ANTICONGELANTE VERDE RADIATORI
- GREEN ANTIFREEZE RADIATOR LIQUID
- PRODUIT ANTIGEL PRÉT À L'EMPLOI POUR RADIATEURS
- Gebrauchsfertiges Frostschutzmittel für Kühler
- ANTICONGELANTE PARA RADIADORES, LISTO PARA SU USO

ACTIVESAFE+



1 Litro

MASTER 12



Anticongelante per radiatori pronto all'uso, protegge dal gelo l'impianto di raffreddamento dell'auto fino ad una temperatura di -22°C. Contiene particolari inibitori di corrosione che ne consentono l'impiego anche in presenza di parti in alluminio. Da utilizzarsi anche in estate per aumentare il punto di ebollizione dell'acqua.

Permanent antifreeze liquid, ready for use, ensures protection down to -22°C. Guarantees total protection of the cooling system of all types of vehicles, including those with engine parts made of aluminium other alloys. The presence of corrosion inhibitors and antifoam agents always guarantees optimum working of the cooling system. May also be used in summer to raise the boiling point of the water.

LIQUIDO RADIATORI GIALLO -30°

77848

- LIQUIDO ANTICONGELANTE GIALLO RADIATORI
- YELLOW ANTIFREEZE RADIATOR LIQUID
- PRODUIT ANTIGEL PRÉT À L'EMPLOI POUR RADIATEURS
- Gebrauchsfertiges Frostschutzmittel für Kühler
- ANTICONGELANTE PARA RADIADORES, LISTO PARA SU USO

ACTIVESAFE+



1 Litro

MASTER 12



Liquido per radiatori auto di tipo permanente formulato con inibitori di natura organica. Il prodotto permette in modo particolare la protezione dei componenti in alluminio e in altre leghe leggere, sempre più usati nei motori di ultima generazione. Riduce notevolmente il verificarsi di fenomeni di corrosione e la formazione di incrostazioni. Il prodotto garantisce la protezione dal gelo fino a -30°C e dall'ebollizione estiva con motore funzionante fino a 128°C.

Permanent car radiator fluid formulated with organic inhibitors. The product especially protects those components made of aluminium and other light alloys, found with increasing frequency in the latest generation of motors engines. Significantly reduces corrosion and the formation of scale. It protects down to -30°C and against boiling during the trip in summer condition up to +128°C.

LIQUIDO RADIATORI ROSSO FLU -30°

77849

- LIQUIDO ANTICONGELANTE ROSSO FLU RADIATORI
- FLUO RED ANTIFREEZE RADIATOR LIQUID
- PRODUIT ANTIGEL PRÉT À L'EMPLOI POUR RADIATEURS
- Gebrauchsfertiges Frostschutzmittel für Kühler
- ANTICONGELANTE PARA RADIADORES, LISTO PARA SU USO

ACTIVESAFE+



1 Litro

MASTER 12



Liquido per radiatori auto di tipo permanente formulato con inibitori di natura organica. Il prodotto permette in modo particolare la protezione dei componenti in alluminio e in altre leghe leggere, sempre più usati nei motori di ultima generazione. Riduce notevolmente il verificarsi di fenomeni di corrosione e la formazione di incrostazioni. Il prodotto garantisce la protezione dal gelo fino a -30°C e dall'ebollizione estiva con motore funzionante fino a 128°C.

Permanent car radiator fluid formulated with organic inhibitors. The product especially protects those components made of aluminium and other light alloys, found with increasing frequency in the latest generation of motors engines. Significantly reduces corrosion and the formation of scale. It protects down to -30°C and against boiling during the trip in summer condition up to +128°C.



LIQUIDO RADIATORI GIALLO PLURISTAGIONALE

77883

- LIQUIDO ANTICONGELANTE GIALLO RADIATORI
- YELLOW ANTIFREEZE RADIATOR LIQUID
- PRODUIT ANTIGEL PRÉT À L'EMPLOI POUR RADIATEURS
- Gebrauchsfertiges Frostschutzmittel für Kühler
- ANTICONGELANTE PARA RADIADORES, LISTO PARA SU USO

ACTIVESAFE+ **PLURISTAGIONALE**
1 Litro
GOODYEAR

MASTER 12



Liquido per radiatori auto di tipo permanente formulato con inibitori di natura organica. Il prodotto permette in modo particolare la protezione dei componenti in alluminio e in altre leghe leggere, sempre più usati nei motori di ultima generazione. Riduce notevolmente il verificarsi di fenomeni di corrosione e la formazione di incrostazioni. Il prodotto garantisce la protezione dal gelo fino a -5°C.

Permanent car radiator fluid formulated with organic inhibitors. The product especially protects those components made of aluminium and other light alloys, found with increasing frequency in the latest generation of motors engines. Significantly reduces corrosion and the formation of scale. It protects down to -5°C.

LIQUIDO RADIATORI ROSSO FLU PLURISTAGIONALE

77882

- LIQUIDO ANTICONGELANTE ROSSO FLU RADIATORI
- FLUO RED ANTIFREEZE RADIATOR LIQUID
- PRODUIT ANTIGEL PRÉT À L'EMPLOI POUR RADIATEURS
- Gebrauchsfertiges Frostschutzmittel für Kühler
- ANTICONGELANTE PARA RADIADORES, LISTO PARA SU USO

ACTIVESAFE+ **PLURISTAGIONALE**
1 Litro
GOODYEAR

MASTER 12



Liquido per radiatori auto di tipo permanente formulato con inibitori di natura organica. Il prodotto permette in modo particolare la protezione dei componenti in alluminio e in altre leghe leggere, sempre più usati nei motori di ultima generazione. Riduce notevolmente il verificarsi di fenomeni di corrosione e la formazione di incrostazioni. Il prodotto garantisce la protezione dal gelo fino a -5°C.

Permanent car radiator fluid formulated with organic inhibitors. The product especially protects those components made of aluminium and other light alloys, found with increasing frequency in the latest generation of motors engines. Significantly reduces corrosion and the formation of scale. It protects down to -5°C.

LIQUIDO RADIATORI BLU PLURISTAGIONALE

77851

- LIQUIDO PLURISTAGIONALE BLU RADIATORI
- BLUE ALL SEASON RADIATOR LIQUID
- RADIATEUR TOUTES SAISONS LIQUIDE
- Flüssigkeitsradiatoren
- RADIADORES PLURISTAGIONALES LÍQUIDOS AZULES

PLURISTAGIONALE
5 Litri
GOODYEAR

MASTER 4



Anticongelante per radiatori pronto all'uso, protegge dal gelo l'impianto di raffreddamento dell'auto fino ad una temperatura di -5°C. Contiene particolari inibitori di corrosione ecologici che ne consentono l'impiego anche in presenza di parti in alluminio. Da utilizzarsi anche in estate per aumentare il punto di ebollizione dell'acqua.

Permanent antifreeze liquid, ready for use, ensures protection down to -5°C. Guarantees total protection of the cooling system of all types of vehicles, including those with engine parts made of aluminium other alloys. The presence of ecological corrosion inhibitors and antifoam agents always guarantees optimum working of the cooling system. May also be used in summer to raise the boiling point of the water.



LIQUIDO RADIATORI BLU INVERNALE -22°

77875

- LIQUIDO ANTICONGELANTE RADIATORI
- BLUE ANTIFREEZE RADIATOR LIQUID
- PRODUIT ANTIGEL PRÉT À L'EMPLOI POUR RADIATEURS
- Gebrauchsfertiges Frostschutzmittel für Kühler
- ANTICONGELANTE PARA RADIADORES, LISTO PARA SU USO

BLU -22° RADIATORI

2 Litri

GOODYEAR

MASTER 6



Anticongelante per radiatori pronto all'uso, protegge dal gelo l'impianto di raffreddamento dell'auto fino ad una temperatura di -22°C. Contiene particolari inibitori di corrosione ecologici che ne consentono l'impiego anche in presenza di parti in alluminio. Da utilizzarsi anche in estate per aumentare il punto di ebollizione dell'acqua.

Permanent antifreeze liquid, ready for use, ensures protection down to - 22°C. Guarantees total protection of the cooling system of all types of vehicles, including those with engine parts made of aluminium other alloys. The presence of ecological corrosion inhibitors and antifoam agents always guarantees optimum working of the cooling system. May also be used in summer to raise the boiling point of the water.

LIQUIDO RADIATORE RADIAFLUIDO

77894

- LIQUIDO ANTICONGELANTE RADIATORI
- ANTIFREEZE RADIATOR LIQUID
- PRODUIT ANTIGEL PRÉT À L'EMPLOI POUR RADIATEURS
- Gebrauchsfertiges Frostschutzmittel für Kühler
- ANTICONGELANTE PARA RADIADORES, LISTO PARA SU USO

BLU

2 Litri

RADIAFLUIDO
GOODYEAR



MASTER 6



Anticongelante per radiatori pronto all'uso, protegge dal gelo l'impianto di raffreddamento dell'auto fino ad una temperatura di -22°C. Contiene particolari inibitori di corrosione ecologici che ne consentono l'impiego anche in presenza di parti in alluminio. Da utilizzarsi anche in estate per aumentare il punto di ebollizione dell'acqua.

Permanent antifreeze liquid, ready for use, ensures protection down to - 22°C. Guarantees total protection of the cooling system of all types of vehicles, including those with engine parts made of aluminium other alloys. The presence of ecological corrosion inhibitors and antifoam agents always guarantees optimum working of the cooling system. May also be used in summer to raise the boiling point of the water.

LIQUIDO RADIATORE RADIAFLUIDO

77895

- LIQUIDO ANTICONGELANTE RADIATORI
- ANTIFREEZE RADIATOR LIQUID
- PRODUIT ANTIGEL PRÉT À L'EMPLOI POUR RADIATEURS
- Gebrauchsfertiges Frostschutzmittel für Kühler
- ANTICONGELANTE PARA RADIADORES, LISTO PARA SU USO

BLU

1 Litro

RADIAFLUIDO
GOODYEAR



MASTER 12



Anticongelante per radiatori pronto all'uso, protegge dal gelo l'impianto di raffreddamento dell'auto fino ad una temperatura di -22°C. Contiene particolari inibitori di corrosione ecologici che ne consentono l'impiego anche in presenza di parti in alluminio. Da utilizzarsi anche in estate per aumentare il punto di ebollizione dell'acqua.

Permanent antifreeze liquid, ready for use, ensures protection down to - 22°C. Guarantees total protection of the cooling system of all types of vehicles, including those with engine parts made of aluminium other alloys. The presence of ecological corrosion inhibitors and antifoam agents always guarantees optimum working of the cooling system. May also be used in summer to raise the boiling point of the water.

ANTICONGELANTE PER RADIATORI

77898

- LIQUIDO ANTICONGELANTE BLU RADIATORI
- ANTIFREEZE RADIATOR LIQUID
- PRODUIT ANTIGEL PRÉT À L'EMPLOI POUR RADIATEURS
- Gebrauchsfertiges Frostschutzmittel für Kühler
- ANTICONGELANTE PARA RADIADORES, LISTO PARA SU USO

-22°C
+112°C

1 Litro

PLURISTAGIONALE
GOODYEAR

MASTER 12



Anticongelante per radiatori pronto all'uso, protegge dal gelo l'impianto di raffreddamento dell'auto fino ad una temperatura di -22°C. Contiene particolari inibitori di corrosione ecologici che ne consentono l'impiego anche in presenza di parti in alluminio. Da utilizzarsi anche in estate per aumentare il punto di ebollizione dell'acqua.

Permanent antifreeze liquid, ready for use, ensures protection down to - 22°C. Guarantees total protection of the cooling system of all types of vehicles, including those with engine parts made of aluminium other alloys. The presence of ecological corrosion inhibitors and antifoam agents always guarantees optimum working of the cooling system. May also be used in summer to raise the boiling point of the water.



PASTA ABRASIVA

77817

- PASTA ABRASIVA
- POLISHING PASTE
- PÂTE ABRASIVE
- Schleifpaste
- PASTA ABRASIVA

250 ml

MASTER 24



Pasta specifica per la rimozione dei piccoli graffi dalla vernice dei veicoli. Stendere una piccola dose di prodotto su un panno asciutto o su ovatta di cotone ed applicare sulla superficie da trattare con delicati movimenti circolari. Procedere con cautela e moderazione, controllando spesso il risultato. Dosare bene la quantità di prodotto e l'intensità della pressione, al fine di non opacizzare od alternare la superficie trattata. Rimuovere con un panno asciutto.

Specific paste for removing small scratches from the vehicles paint. Apply a small amount of product on a dry cloth or cotton wool and spread with regular movements. Check from time to time the result, proceeding gently and with attention. Carefully dose the amount of product and the pressure intensity, to avoid an undesired matt effect to the surface. Remove with a dry cloth.

TRATTAMENTO MULTIFUNZIONE DIESEL

77560

- TRATTAMENTO MULTIFUNZIONE SPECIFICO PER DIESEL/GASOLIO
- DIESEL MULTIFUNCTION TREATMENT
- TRAITEMENT MULTIFONCTIONNEL DIESEL / GASOLIO
- DIESEL / GASOLIO Multifunktionale Behandlung
- DIESEL / GASOLIO TRATAMIENTO MULTIFUNCIONAL

200 ml

MASTER 24



Per un motore sempre come nuovo. Deterge i fori degli iniettori consentendo la perfetta nebulizzazione del gasolio, protegge da eventuali tracce d'acqua, lubrifica la pompa e gli iniettori, aiuta a diminuire il consumo di carburante, abbatta la rumorosità, riduce le emissioni inquinanti.

Dose indicata per un pieno di 60lt. Versare l'additivo nel serbatoio prima del rifornimento. Indispensabile ogni circa 2.500 km, ideale ad ogni rifornimento. Adatto a tutti i motori Diesel aspirati e turbo, ad iniezione diretta od indiretta, anche con FAP e sistema ADBLUE. Compatibile con BioDiesel.

TRATTAMENTO MULTIFUNZIONE BENZINA

77561

- TRATTAMENTO MULTIFUNZIONE SPECIFICO PER BENZINA
- GASOLINE MULTIFUNCTION TREATMENT
- GASOLINE TRAITEMENT MULTIFONCTIONNEL
- BENZIN Multifunktionale Behandlung
- GASOLINA TRATAMIENTO MULTIFUNCIONAL

200 ml

MASTER 24



Per un motore sempre al massimo della condizione di efficienza. Impedisce la formazione e l'accumulo di depositi ed incrostazioni nella camera di combustione e sulle valvole, mantiene perfettamente pulito l'impianto di alimentazione consentendo il lavoro ottimale degli iniettori, riduce i consumi, la rumorosità ed i fumi allo scarico. Elimina i battiti in testa. Compatibile con tutti i sistemi di abbattimento dei gas di scarico.

Dose indicata per un pieno di 60lt di benzina. Versare l'additivo nel serbatoio prima del rifornimento. Indispensabile ogni circa 2.500 km, ideale ad ogni rifornimento. Adatto a tutti i motori Benzina aspirati e turbo, ad iniezione diretta e a doppia alimentazione (GPL o Metano).

TRATTAMENTO DIESEL ANTIGELO

77563

- TRATTAMENTO DIESEL ANTIGELO INVERNALE
- DIESEL ANTI FREEZE WINTER TREATMENT
- ANTIGEL DIESEL
- Frostschutz Diesel
- DIESEL ANTICONGELANTE

-20°

200 ml

MASTER 24



Facilita l'accensione a freddo durante le rigide giornate invernali. Speciale formula anti congelamento del gasolio: previene la solidificazione dei cristalli di paraffina spesso causa dell'intasamento del filtro e consentendo una corretta erogazione del flusso del carburante. Riduce rumore, fumosità ed emissioni prevenendo perdite di potenza. Pulisce ed elimina i depositi che potrebbero formarsi nel sistema di alimentazione. Migliora la fluidità e l'erogazione del motore. Contiene sostanze anti corrosive e protettive.

Dose indicata per un pieno di 60lt. Versare l'additivo nel serbatoio prima del rifornimento. Ideale ad ogni rifornimento. Adatto a tutti i motori Diesel aspirati e turbo, ad iniezione diretta od indiretta, anche con FAP e sistema ADBLUE. Compatibile con BioDiesel.

SBLOKKA - LUBRIFICANTE

77840

- SBLOCCANTE LUBRIFICANTE
- PENETRATING LUBRICANT
- DÉGRIPPANT LUBRIFIANT
- Schraubenlöser/Schmiermittel
- AFLOJA-LUBRICA ROSCAS

SBLOKKA



450 ml

MASTER 24

GOODYEAR



Contiene oli ad elevato potere lubrificante e penetrante. Libera viti, bulloni, cerniere da ruggine e incrostazioni garantendo una futura protezione per le parti trattate.

Penetrating product containing high-lubricant, penetrating oil. Penetrates rust and corrosion to loosen screws, bolts and hinges, while leaving a coating for future protection.



SBLOKKA - LUBRIFICANTE

77841

- SBLOCCANTE LUBRIFICANTE
- PENETRATING LUBRICANT
- DÉGRIPPANT LUBRIFIANT
- Schraubenlöser/Schmiermittel
- AFLOJA-LUBRICA ROSCAS

SBLOKKA



250 ml

MASTER 24

GOODYEAR



Contiene oli ad elevato potere lubrificante e penetrante. Libera viti, bulloni, cerniere da ruggine e incrostazioni garantendo una futura protezione per le parti trattate.

Penetrating product containing high-lubricant, penetrating oil. Penetrates rust and corrosion to loosen screws, bolts and hinges, while leaving a coating for future protection.

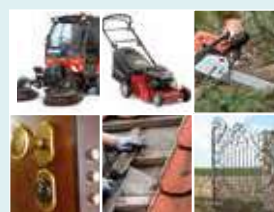

SVITA LUBRIFICA SBLOCCA

77857

- SBLOCCANTE LUBRIFICANTE
- PENETRATING LUBRICANT
- DÉGRIPPANT LUBRIFIANT
- Schraubenlöser/Schmiermittel
- AFLOJA-LUBRICA ROSCAS

SVITA LUBRIFICA SBLOCCA

450 ml

MASTER 24

GOODYEAR



Contiene oli ad elevato potere lubrificante e penetrante. Rimuove viti, bulloni, cerniere da ruggine e incrostazioni garantendo una futura protezione per le parti trattate.

Agitare la bombola (se necessario applicare la cannuccia), spruzzare sulle parti bloccate. Lasciare agire per qualche minuto poi muovere.



LIQUIDO FRENI DOT 4

77856

- FLUIDO SINTETICO PER FRENI DOT4
- DOT4 BRAKE FLUID
- LIQUIDE FREINS DOT4
- Bremsflüssigkeit DOT4
- LÍQUIDO DE FRENOS DOT4

250 ml

MASTER 48

GOODYEAR



Liquido sintetico per freni ad alto punto d'ebollizione, per tutti i circuiti di frenaggio a disco o a tamburo. Indicato per auto, camion ecc. Importante: non lasciare il prodotto aperto, assorbe umidità.

Synthetic brake fluid with high boiling point for all types of disk and drum brakes. Recommended for cars, lorries, buses, etc. Important: is absorbs humidity, don't leave the product opened.





CROMATURE BRILLANTI

77884

- CROMATURE BRILLANTI
- CHROMED PARTS
- CHROMATURES BRILLANTES
- Verchromte Teile
- CROMATURAS DE BRILLO

150 ml

MASTER 12



Ripristina-Lucida-Protegge

Restore-Polish-Protect



RIMUOVI GRAFFI

77896

- RIMUOVI GRAFFI
- SCRATCH REMOVER
- DÉCAPANT D'ÉCRASEMENT
- Kratzerentferner
- REMOVEDOR DE RAYONES

150 ml

MASTER 12



Stendere il prodotto sul graffio da trattare con un panno morbido di lana o cotone. Strofinare energeticamente e ripetere più volte se necessario. Evitare una pressione eccessiva. Rimuove graffi, segni e ossidazioni da superfici metalliche e plastiche verniciate o cromate. Ideale per auto, moto, furgoni...



RINNOVA FANALI

77897

- RINNOVA FANALI
- LIGHTS RESTORER
- RENOUVELER LES CANAUX
- Erneuern sie die Kanäle
- RENOVAR LOS CANALES

150 ml

MASTER 12



Stendere il prodotto sulla parabola dei fari con un panno morbido di lana o cotone. Strofinare energeticamente e ripetere più volte se necessario. Rimuove l'opacità, gli aloni ed elimina i graffi. Consigliato prima di ogni revisione. Ideale per auto, moto, furgoni... e per tutti i fari in policarbonato.



2 ROTOLI CARTA OFFICINA

77876

- 2 ROTOLI CARTA OFFICINA
- 2 PAPERS ROLLS
- PAPIER OFFICINE 2 ROULEAUX
- 2 Rollen Offizielles Papier
- 2 ROLLOS OFFICINE PAPEL



MASTER 12



millensi

DETERGENTE CASCHI E VISIERE

77874

- DETERGENTE CASCHI E VISIERE
- HELMETHS AND VISORS CLEANER
- DÉTERGENT DE CASH ET DE VISIÈRE
- Cash und Visor Detergent
- DETERGENTE EN EFECTIVO Y VISOR

75 ml

MASTER 24



Detergente appositamente formulato per la pulizia interna ed esterna del casco e visiere/frontalini. Pulisce a fondo anche le superfici interne di tessuto eliminando le tracce di sporco ed è efficace anche per togliere tracce di smog, insetti, polvere dalla parte esterna del casco.



LUCIDA CARENATURA E PLASTICHE

77885

- LUCIDA CARENATURA E PLASTICHE
- MOTORBIKE BODY AND PLASTIC FAIRINGS POLISHER
- POLISSAGE ET POLISSAGE PLASTIQUE
- Polieren und Plastik Polieren
- PULIDO Y PULIDO DE PLÁSTICO

75 ml

MASTER 24



Formulato completamente esente da solventi e propellenti in grado di pulire e proteggere tutte le superfici in plastica e gomma delle moto. Grazie alla presenza di speciali additivi forma un film particolarmente efficace che impedisce agli agenti atmosferici di danneggiare le parti trattate.



PANNO LUCIDANTE MOTO

77888

- PANNO LUCIDANTE E PULENTE
- POLISHING AND CLEANING CLOTH
- POLISSAGE ET POULIE
- Polier- und Riemenscheibe
- PULVERIZACIÓN Y POLEA PAN

MASTER 144
INNER 24



IN MICROFIBRA



GUANTO LUCIDANTE

77889

- GUANTO LUCIDANTE E PULENTE IN MICROFIBRA
- PROFESSIONAL MICROFIBER CLEANER GLOVES
- GANT DE MICROFIBRE PULSE
- Mikrofaser Impulshandschuh
- GUANTE DE PULSO MICROFIBRA

MASTER 144
INNER 24





SALVIETTE AUTO PLASTICA & CRUSCOTTI

77702

- SALVIETTE AUTO PLASTICA & CRUSCOTTI
- CAR WIPES DASHBOARD & PLASTIC
- VOITURE ADAPTÉE
- Helied Auto
- COCHE ASISTIDO



20
pcs



MASTER 96 INNER 24

Efficace nel rimuovere tracce di sporco. Pulisce, protegge e rende lucido qualsiasi tipo di cruscotto e plastica.

Effective in removing dirt. It cleans, protects and makes shiny every kind of dashboard and plastic.



effetto lucido
gloss finish

SALVIETTE AUTO TRATTAMENTO PELLE

77703

- SALVIETTE AUTO TRATTAMENTO PELLE
- CAR WIPES LEATHER CARE
- VOITURE ADAPTÉE
- Helied Auto
- COCHE ASISTIDO



20
pcs



MASTER 96 INNER 24

Elimina lo sporco più tenace e nel contempo nutre e protegge tutte le superfici in pelle.

Eliminates the strongest dirt and at the same time protects and feeds leather surfaces.



SALVIETTE AUTO INTERNI E TESSUTI

77704

- SALVIETTE AUTO INTERNI E TESSUTI
- CAR WIPES UPHOLSTERY AND INTERIORS
- VOITURE ADAPTÉE
- Helied Auto
- COCHE ASISTIDO



20
pcs



MASTER 96 INNER 24

Elimina le macchie di sporco dai sedili, dai pannelli e dai tappeti della tua vettura.

Removes dirt from seats, panels and carpets of your car.



SALVIETTE AUTO DETERGENTE VETRI

77705

- SALVIETTE AUTO DETERGENTE VETRI
- CAR WIPES GLASS CLEANER
- VOITURE ADAPTÉE
- Helied Auto
- COCHE ASISTIDO



20
pcs



MASTER 96 INNER 24

Salviette per vetri e specchi. Detergono in profondità rimuovendo ogni tipo di impurità.

Glass and mirrors wipes. Cleans deeply and removes every kind of impurity.



SALVIETTE AUTO PLASTICA & CRUSCOTTI

77701

- SALVIETTE AUTO PLASTICA & CRUSCOTTI
- CAR WIPES DASHBOARD & PLASTIC
- VOITURE ADAPTÉE
- Helied Auto
- COCHE ASISTIDO



20
pcs



MASTER 96 INNER 24

Efficace nel rimuovere tracce di sporco. Pulisce e protegge senza ungere qualsiasi tipo di cruscotto e plastica.

Effective in removing dirt. It cleans and protects every kind of dashboard and plastic.



**effetto opaco
matt finish**

PELLE SINTETICA

77420

- PELLE SINTETICA
- SYNTHETIC MULTI PURPOSE CLOTH
- CHIFFON EN MICROFIBRE
- MIKROFASERTUCH
- PAÑO DE MICROFIBRA



STOP ALONI

MISURA/SIZE 43X32 CM

MASTER 24

Nuova Pelle Sintetica multi-uso.

Il PVA è apprezzato dai professionisti per la pulizia profonda e la grande assorbenza, che si traducono in una pulizia senza aloni dopo l'asciugatura. Dura a lungo ed è molto versatile su vetro, carrozzeria, plastiche e su tutte le superfici dure in genere. Va usato umido, ben strizzato. Riporre nel suo astuccio dopo l'uso. Lavabile a mano a 40°.

New Synthetic multi-purpose cloth. PVA is well appreciated by professionals for the high cleaning properties and the great absorbency, that means no stains or marks after drying. It has a long life and it is versatile on glass, car body, plastic and all the hard surfaces. For wet use, well squeezed. Store in the plastic can after use. 40° hand wash.

PELLE SCAMOSCIATA IN MICROFIBRA

77423

- PELLE SCAMOSCIATA IN MICROFIBRA ALKANTARA
- MICROFIBER SYNTETIC CHAMOIS LEATHER
- CHIFFON EN MICROFIBRES SUEDE
- Mikrofaser Suede
- PAÑO DE MICROFIBRA SUEDE

ALKANTARA



MISURA/SIZE XXL

MASTER 144 INNER 36



**USATA ASCIUTTA:
IMPIEGO**



PER L'AUTO

PULIZIA DEL CRUSCOTTO, CARROZZERIA, VETRI, SPECCHI RETROVISORI, ECC.

**USATA BAGNATA:
IMPIEGO**



PER L'AUTO

PULIZIA DEL PARABREZZA, FANALI, VETRI, CARROZZERIA, ECC.

**USATA ASCIUTTA:
IMPIEGO**



PER LA CASA

PULIZIA DEL COMPUTERS, TV, HI-FI, OCCHIALI, MOBILI, ARGENTERIA, SPECCHI ECC.

**USATA BAGNATA:
IMPIEGO**



PER LA CASA

PULIZIA DI CUCINE, VETRI, SPECCHI, BAGNI, SANITARI, BRICOLAGE, ECC.

PELLE SCAMOSCIATA IN MICROFIBRA

77424

- PELLE SCAMOSCIATA IN MICROFIBRA
- MICROFIBER SYNTETIC CHAMOIS LEATHER
- CHIFFON EN MICROFIBRES SUEDE
- Mikrofaser Suede
- PAÑO DE MICROFIBRA SUEDE



MISURA/SIZE LARGE

MASTER 144 INNER 36



**USATA ASCIUTTA:
IMPIEGO**



PER L'AUTO

PULIZIA DEL CRUSCOTTO, CARROZZERIA, VETRI, SPECCHI RETROVISORI, ECC.

**USATA BAGNATA:
IMPIEGO**



PER L'AUTO

PULIZIA DEL PARABREZZA, FANALI, VETRI, CARROZZERIA, ECC.

**USATA ASCIUTTA:
IMPIEGO**



PER LA CASA

PULIZIA DEL COMPUTERS, TV, HI-FI, OCCHIALI, MOBILI, ARGENTERIA, SPECCHI ECC.

**USATA BAGNATA:
IMPIEGO**



PER LA CASA

PULIZIA DI CUCINE, VETRI, SPECCHI, BAGNI, SANITARI, BRICOLAGE, ECC.



DAINOPELL SCAMOSCIATA



77425

- PELLE SINTETICA SCAMOSCIATA NATURALE
- SYNTHETIC CHAMOIS LEATHER
- PEAU DE CHAMOIS SYNTHETIQUE
- Kunstwilledertuch
- GAMUZA PIEL SINTÉTICA



MISURA/SIZE LARGE

MASTER 144 INNER 36



Il panno DAINOPELL Tuttofare è realizzato con un'alta percentuale di fibre di origine naturale ad alto potere assorbente. Utilizzabile con qualsiasi detergente, non lascia pelucchi o aloni. Ideale per tutti i tipi di pulizia, auto, moto, furgoni, camion, barche, biciclette, cucina, bagno, mobili laccati, ecc... Si consiglia, prima dell'uso, di bagnare il panno in acqua calda e strizzare. Lavabile in lavatrice a 60°.

The DAINOPELL All-Purpose cloth is made with a high percentage of fibres of natural origin with a high absorbent capacity. Usable with any detergent, it is lint-free and leaves no rings. Ideal for all types of cleaning, kitchen, bathroom, lacquered furniture, etc... Before use it is recommended to wet the cloth in warm water and squeeze. Machine washable at 60°C.

DAINOLUX SCAMOSCIATO



77427

- PANNO IN MICROFIBRA SCAMOSCIATO
- CLOTH MICROFIBER SUEDE
- CHIFFON EN MICROFIBRES SUEDE
- Mikrofaser Suede
- PAÑO DE MICROFIBRA SUEDE



MISURA/SIZE LARGE

MASTER 144 INNER 36



Il panno DAINOLUX Tuttofare è realizzato con un'alta percentuale di fibre di origine naturale ad alto potere assorbente. Utilizzabile con qualsiasi detergente, non lascia pelucchi o aloni. Ideale per tutti i tipi di pulizia, auto, moto, bici, furgone, camion, barche, cucina, bagno, mobili laccati, ecc... Si consiglia, prima dell'uso, di bagnare il panno in acqua calda e strizzare. Lavabile in lavatrice a 60°.

The DAINOLUX All-Purpose cloth is made with a high percentage of fibres of natural origin with a high absorbent capacity. Usable with any detergent, it is lint-free and leaves no rings. Ideal for all types of cleaning, kitchen, bathroom, lacquered furniture, etc... Before use it is recommended to wet the cloth in warm water and squeeze. Machine washable at 60°C.

DAINOBRILL SCAMOSCIATO



77428

- PELLE SINTETICA SCAMOSCIATA NATURALE
- SYNTHETIC CHAMOIS LEATHER
- PEAU DE CHAMOIS SYNTHETIQUE
- Kunstwilledertuch
- GAMUZA PIEL SINTÉTICA



MISURA/SIZE LARGE

MASTER 144 INNER 36



Il panno DAINOBRILL Vetri è realizzato solo con microfibre di origine naturale, trattate in modo da garantire la massima efficacia e resistenza. Il 100% di viscosa permette di raggiungere un potere assorbente senza precedenti, di molto superiore ad un panno tradizionale, mentre la speciale spalmatura e il compattamento delle fibre rendono il panno molto scorrevole, facilitandone l'utilizzo. Eccezionale su tutte le superfici lucide, in particolar modo su cristallo e acciaio. Si consiglia, prima dell'uso, di bagnare il panno in acqua calda e strizzare. Lavabile in lavatrice a 60°.

The DAINOBRILL Window cloth is made only with microfibrils of natural origin, treated so as to guarantee the greatest effectiveness and strength. Exceptional on all shiny surfaces, especially on crystal and steel. Before use it is recommended to wet the cloth in warm water and squeeze. Machine washable at 60°C.

DAINOCLEAN SCAMOSCIATO



77429

- PANNO IN MICROFIBRA SCAMOSCIATO
- CLOTH MICROFIBER SUEDE
- CHIFFON EN MICROFIBRES SUEDE
- Mikrofaser Suede
- PAÑO DE MICROFIBRA SUEDE



MISURA/SIZE XL

MASTER 144 INNER 36



Il panno DAINOCLEAN, ricco di fibre di origine naturale, lava e asciuga tutti i tipi di superficie della tua auto. Ideale per tutti i tipi di pulizia, auto, moto, bici, furgone, camion, barche, cucina, bagno, mobili laccati, ceramiche, marmi, cotto, ecc... Scorrevole e resistente, garantisce ottimi risultati riducendo la fatica. Si consiglia, prima dell'uso, di bagnare il panno in acqua calda e strizzare. Lavabile in lavatrice a 60°.

The DAINOCLEAN, rich in fibres of natural origin, washes and dries all types of surfaces, such as ceramic tiles, marble, terracotta, etc... Smooth and strong, it guarantees excellent results reducing fatigue. Before use it is recommended to wet the cloth in warm water and squeeze. Machine washable at 60°C.

PANNO MICROFIBRA VETRI

77414

- PANNO MICROFIBRA PER VETRI
- MICROFIBER WINDOW CLOTH
- CHIFFON EN MICROFIBRE
- Mikrofaser Tuch
- PAÑO DE MICROFIBRA



MISURA/SIZE 40X40 CM



MASTER 24

CARATTERISTICHE: Realizzato con le migliori tecnologie per ottenere una microfibra speciale ed unica. Utilizzo specifico su tutte le parti in vetro e plastica della tua auto (vetri, fari, specchi...). Non graffia, non lascia pelucchi.

FEATURES: Microfibre cloth. Ideal for washing and drying, easy to keep in the car. Specially made for glass and plastic parts (windows, headlights, mirrors...). Best used when wet.



PANNO MICROFIBRA CARROZZERIA

77416

- PANNO MICROFIBRA PER CARROZZERIA
- MICROFIBER CAR BODY CLOTH
- CHIFFON EN MICROFIBRE
- Mikrofaser Tuch
- PAÑO DE MICROFIBRA



MISURA/SIZE 40X40 CM



MASTER 24

CARATTERISTICHE: Realizzato con le migliori tecnologie per ottenere una microfibra speciale ed unica. Utilizzo specifico per l'esterno e la carrozzeria della tua auto (pulisce e lucida la carrozzeria, le parti cromate, i fascioni in plastica...). Non graffia, non lascia pelucchi.

FEATURES: Microfiber cloth, ideal to washing and drying, easy to keep in the car. Specially made for the car body (metal parts, chromed areas, bumpers...). Best used when wet.



PANNO MICROFIBRA INTERNI

77415

- PANNO MICROFIBRA INTERNI
- MICROFIBER INTERIOR CLOTH
- CHIFFON EN MICROFIBRE
- Mikrofaser Tuch
- PAÑO DE MICROFIBRA



MISURA/SIZE 40X40 CM



MASTER 24

CARATTERISTICHE: Realizzato con le migliori tecnologie per ottenere una microfibra speciale ed unica. Utilizzo specifico per l'abitacolo della tua auto (cruscotto, sedili, tunnel, aree difficili...). Non graffia, non lascia pelucchi.

FEATURES: Microfiber cloth, ideal for washing and drying, easy to keep in the car. Specially made for the interior of your car (dashboard, seats, difficult areas...). Best used when wet.





PANNO MICROFIBRA MULTIUSO

77417

- PANNO MICROFIBRA MULTIUSO
- MICROFIBER MULTIPURPOSE CLOTH
- CHIFFON EN MICROFIBRE
- Mikrofasertuch
- PAÑO DE MICROFIBRA



MISURA/SIZE 40X40 CM



MASTER 24

CARATTERISTICHE: Realizzato con le migliori tecnologie per ottenere una microfibra speciale ed unica. Utilizzo senza limitazioni per tutte le superfici della tua auto (esterni, interni, vetri...). La speciale tessitura del panno garantisce un ottimo risultato per ogni impiego di lucidatura e pulizia della vettura. Non graffia, non lascia pelucchi.

FEATURES: Microfiber cloth, ideal for washing and drying, easy to keep in the car. Specially made for all the areas of your car (exteriors, interiors, glass...). Best used when wet.



GUANTO MICROFIBRA MULTIUSO

77418

- GUANTO MICROFIBRA MULTIUSO
- MICROFIBER MULTIPURPOSE GLOVE
- EPONGE EN MICROFIBRE
- Mikrofaserschwamm
- ESPONJA MICROFIBRA



MISURA/SIZE EXTRA LARGE



MASTER 24

CARATTERISTICHE: realizzato con le migliori tecnologie per ottenere una microfibra speciale ed unica. Utilizzo senza limitazioni per tutte le superfici della tua auto (esterni, interni, vetri...). La speciale tessitura del guanto garantisce un ottimo risultato per ogni impiego di lucidatura e pulizia della vettura. Lato in ciniglia perfetto per insaponare e lavare, lato in microfibra indicato per lucidare, asciugare e per una pulizia generale. Non graffia, non lascia pelucchi.

FEATURES: microfiber sponge, ideal for washing and drying, easy to keep in the car. Specially made for all the areas of your car (exteriors, interiors, glass...). The Chenille side is perfect for washing and soaping. The microfiber side is suitable for polishing, drying and general cleaning. Best used when wet.



SPUGNA MICROFIBRA MULTIUSO

77419

- SPUGNA MICROFIBRA MULTIUSO
- MICROFIBER MULTIPURPOSE SPONGE
- EPONGE EN MICROFIBRE
- Mikrofaserschwamm
- ESPONJA MICROFIBRA



MISURA/SIZE EXTRA LARGE



MASTER 24

CARATTERISTICHE: realizzata con le migliori tecnologie per ottenere una microfibra speciale ed unica. Utilizzo senza limitazioni per tutte le superfici della tua auto (esterni, interni, vetri...). La speciale tessitura della spugna garantisce un ottimo risultato per ogni impiego di lucidatura e pulizia della vettura. Lato in ciniglia perfetto per insaponare e lavare, lato in microfibra indicato per lucidare, asciugare e per una pulizia generale. Non graffia, non lascia pelucchi.

FEATURES: microfiber sponge, ideal for washing and drying, easy to keep in the car. Specially made for all the areas of your car (exteriors, interiors, glass...). The chenille side is perfect for washing and soaping. The microfiber side is suitable for polishing, drying and general cleaning. Best used when wet.



SALVIETTE AUTO PLASTICA & CRUSCOTTI

76110

- SALVIETTE AUTO PLASTICA & CRUSCOTTI
- CAR WIPES DASHBOARD & PLASTIC
- VOITURE ADAPTÉE
- Helied Auto
- COCHE ASISTIDO



20
pcs



MASTER 96 INNER 24

Efficace nel rimuovere tracce di sporco. Pulisce, protegge e rende lucido qualsiasi tipo di cruscotto e plastica.

Effective in removing dirt. It cleans, protects and makes shiny every kind of dashboard and plastic.



effetto lucido
gloss finish

SALVIETTE AUTO PLASTICA & CRUSCOTTI

76111

- SALVIETTE AUTO PLASTICA & CRUSCOTTI
- CAR WIPES DASHBOARD & PLASTIC
- VOITURE ADAPTÉE
- Helied Auto
- COCHE ASISTIDO



20
pcs



MASTER 96 INNER 24

Efficace nel rimuovere tracce di sporco. Pulisce e protegge senza ungere qualsiasi tipo di cruscotto e plastica.

Effective in removing dirt. It cleans and protects every kind of dashboard and plastic.



effetto opaco
matt finish

SALVIETTE AUTO DETERGENTE VETRI

76113

- SALVIETTE AUTO DETERGENTE VETRI
- CAR WIPES GLASS CLEANER
- VOITURE ADAPTÉE
- Helied Auto
- COCHE ASISTIDO



20
pcs



MASTER 96 INNER 24

Salvietine per vetri e specchi. Detergono in profondità rimuovendo ogni tipo di impurità.

Glass and mirrors wipes. Cleans deeply and removes every kind of impurity.





SALVIETTE AUTO TRATTAMENTO PELLE

76114

- SALVIETTE AUTO TRATTAMENTO PELLE
- CAR WIPES LEATHER CARE
- VOITURE ADAPTÉE
- Helied Auto
- COCHE ASISTIDO



20
pcs



MASTER 96 INNER 24

Elimina lo sporco più tenace e nel contempo nutre e protegge tutte le superfici in pelle.

Eliminates the strongest dirt and at the same time protects and feeds leather surfaces.



SALVIETTE AUTO INTERNI E TESSUTI

76115

- SALVIETTE AUTO INTERNI E TESSUTI
- CAR WIPES UPHOLSTERY AND INTERIORS
- VOITURE ADAPTÉE
- Helied Auto
- COCHE ASISTIDO



20
pcs



MASTER 96 INNER 24

Elimina le macchie di sporco dai sedili, dai pannelli e dai tappeti della tua vettura.

Removes dirt from seats, panels and carpets of your car.



PELLE SINTETICA

76099

- PELLE SINTETICA
- SYNTHETIC MULTI PURPOSE CLOTH
- PEAU SYNTHETIQUE
- Synthetische Haut
- PIEL SINTÉTICA

MASTER 24



Nuova Pelle Sintetica multi-uso. Il PVA è apprezzato dai professionisti per la pulizia profonda e la grande assorbenza, che si traducono in una pulizia senza aloni dopo l'asciugatura. Dura a lungo ed è molto versatile su vetro, carrozzeria, plastiche e su tutte le superfici dure in genere. Va usato umido, ben strizzato. Riporre nel suo astuccio dopo l'uso. Lavabile a mano a 40°.

New Synthetic multi-purpose cloth. PVA is well appreciated by professionals for the high cleaning properties and the great absorbency, that means no stains or marks after drying. It has a long life and it is versatile on glass, car body, plastic and all the hard surfaces. For wet use, well squeezed. Store in the plastic can after use. 40° hand wash.

PANNO IN MICROFIBRA

76100

- PANNO IN MICROFIBRA
- MICROFIBRE CLOTH
- CHIFFON EN MICROFIBRE
- Mikrofaserstuch
- PAÑO DE MICROFIBRA

MASTER 24



Prodotto adatto alla pulizia dell'auto o della casa non lascia peli nè residui calcarei.

Product suitable for cleaning your car or your home. Does not leave any residue.

PANNO IN MICROFIBRA

76101

- PANNO IN MICROFIBRA PER VETRI
- MICROFIBRE WINDOW CLOTH
- CHIFFON EN MICROFIBRE POUR VITRES
- Mikrofaserfenstertuch
- PAÑO DE MICROFIBRA PARA VENTANILLAS

MASTER 24

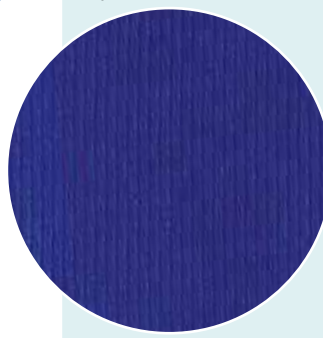

Realizzato con le migliori tecnologie per ottenere una microfibra speciale ed unica. Utilizzo specifico su tutte le parti in vetro e plastica della tua auto (vetri, fari, specchi...).

Non graffia, non lascia pelucchi.

Microfibre cloth. Ideal for washing and drying, easy to keep in the car. Specially made for glass and plastic parts (windows, headlights, mirrors...). Best used when wet.

PANNO IN MICROFIBRA PER CARROZZERIA

76102

- PANNO IN MICROFIBRA PER CARROZZERIA
- MICROFIBRE CAR BODY CLOTH
- CHIFFON EN MICROFIBRE POUR CARROSSERIE
- Mikrofaserstuch Fahrzeugkarosserie
- PAÑO DE MICROFIBRA PARA CARROCEÍA

MASTER 24

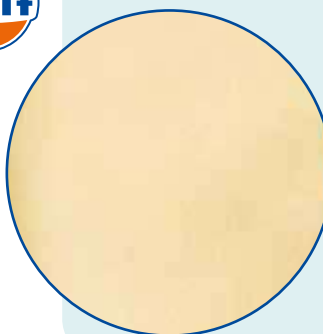

Realizzato con le migliori tecnologie per ottenere una microfibra speciale ed unica. Utilizzo specifico per l'esterno e la carrozzeria della tua auto (pulisce e lucida la carrozzeria, le parti cromate, i fascioni in plastica...).

Non graffia, non lascia pelucchi.

Microfiber cloth, ideal for washing and drying, easy to keep in the car. Specially made for the car body (metal parts, chromed areas, bumpers...). Best used when wet.



RAVVIVANTE GOMME

31268

- DETERGENTE RAVVIVANTE PNEUMATICI
- TYRE SHINE
- RÉNOVATEUR PNEUMATIQUES
- Reifenauffrischer
- NEGRO PARA NEUMÁTICOS

1 Litro

MASTER 24



Liquido di altissima qualità che ridona colore e morbidezza ai pneumatici e alle parti in gomma trattate. Resiste nel tempo.

High-quality liquid that restores original colour and softness to tyres and other treated rubber components. Resistant over time.



NERO GOMME

31701

- DETERGENTE RAVVIVANTE PNEUMATICI
- TYRE SHINE
- RÉNOVATEUR PNEUMATIQUES
- Reifenauffrischer
- NEGRO PARA NEUMÁTICOS

750 ml

MASTER 12



Liquido di altissima qualità che ridona colore e morbidezza ai pneumatici e alle parti in gomma trattate. Resiste nel tempo.

High-quality liquid that restores original colour and softness to tyres and other treated rubber components. Resistant over time.



DETERGENTE CERCHI

31702

- DETERGENTE CERCHI IN LEGA/FERRO
- WHEEL DETERGENT
- DÉTERGENT POUR JANTES EN ALLIAGE
- Felgenreiniger für Leichtmetallfelgen
- LIMPIEZA DE LLANTAS

750 ml

MASTER 12



Usato regolarmente, il prodotto Detergente Cerchi rimuove sporco e grasso da tutti i tipi di cerchioni in alluminio, acciaio o plastica, con superfici cromate o lucide, rinnovandole e rendendo la superficie lucente.

Wheel Detergent removes grease and dirt from all the alloy, steel and plastic wheels, chromed and polished. It perfectly refurbish and polish the surface.



NERO GOMME SCHIUMA ATTIVA

31269-31271

- LUCIDA NERO GOMME, SCHIUMA ATTIVA
- TIRE SHINE, ACTIVE FOAM
- NOIR NOUVEAU CAOUTCHOUC
- Schwarz Gummi
- NEGRO CAUCHO NEGRO



- Deterge
- Non unge
- Lucida
- Ravviva
- Nutre

31269	650ml
31271	250ml

MASTER 24



LUCIDA GOMME in schiuma è il nuovo e facilissimo prodotto perfetto per prenderti cura delle gomme dei tuoi veicoli. Basta una semplicissima spruzzata sullo pneumatico, e la schiuma attiva farà tutto da sola, senza panni, senza rimuovere o stendere il prodotto. LUCIDA GOMME in schiuma non solo ha un effetto detergente che rimuove lo sporco accumulato con il tempo, ma al contempo lascia una pellicola lucida su tutta la superficie, che esalta il profilo del veicolo e protegge la gomma dai raggi UV e dalle intemperie, prevenendone il naturale screpolamento e la decolorazione.

SHINE FOAM is the new and easy solution for your vehicles tires care. With just one spray the foam activates immediately, without clothes, without product removal or applying. TIRE SHINE Foam not only has a cleaning power that removes dirt, but also leaves a shiny film on the surface, that enhances the vehicle profile and protects the tire against the UV rays and the elements, preventing discoloration and cracks.



GONFIA E RIPARA PNEUMATICI

31380

- GONFIA E RIPARA
- TYRE REPAIR
- GONFLE ET RÉPARE
- Reifenfüll-und Dichtmittel
- HINCHA Y REPARA NEUMÁTICOS



450 ml

MASTER 24

Prodotto di emergenza. In caso di foratura del pneumatico, permette di poter raggiungere il centro di assistenza più vicino. Pratico e funzionale renderà più sicuri i vostri viaggi.

Inflates and repairs for Emergencies. In the case of tyre punctures, this will allow you to reach the nearest assistance centre. Practical and easy to use, makes your journeys safer.



SPEED AND GO PNEUMATICI

35205

- GONFIA E RIPARA PNEUMATICI
- TYRE REPAIR INFLATES AND REPAIRS FOR EMERGENCIES
- GONFLE ET RÉPARE PRODUIT D'URGENCE
- Reifenfüll-und Dichtmittel Erzeugnis für Notfälle
- HINCHA Y REPARA NEUMÁTICOS PRODUCTO DE EMERGENCIA



450 ml

MASTER 24

Prodotto di emergenza. In caso di foratura del pneumatico, permette di poter raggiungere il centro di assistenza più vicino. Pratico e funzionale renderà più sicuri i vostri viaggi.

Inflates and repairs for Emergencies. In the case of tyre punctures, this will allow you to reach the nearest assistance centre. Practical and easy to use, makes your journeys safer.



SBLOCCANTE LUBRIFICANTE

31384

- SBLOCCANTE LUBRIFICANTE
- PENETRATING LUBRICANT
- DÉGRIPPANT LUBRIFIANT
- SCHRAUBENLÖSER/SCHMIERMITTEL
- AFLOJA-LUBRICA ROSCAS



250 ml

MASTER 24

Contiene oli ad elevato potere lubrificante e penetrante. Rimuove viti, bulloni, cerniere da ruggine e incrostazioni garantendo una futura protezione per le parti trattate.

Penetrating product containing high-lubricant, penetrating oil. Penetrates rust and corrosion to loosen screws, bolts and hinges, while leaving a coating for future protection.

SBLOCCANTE LUBRIFICANTE

31385

- SBLOCCANTE LUBRIFICANTE
- PENETRATING LUBRICANT
- DÉGRIPPANT LUBRIFIANT
- SCHRAUBENLÖSER/SCHMIERMITTEL
- AFLOJA-LUBRICA ROSCAS



450 ml

MASTER 24

Contiene oli ad elevato potere lubrificante e penetrante. Rimuove viti, bulloni, cerniere da ruggine e incrostazioni garantendo una futura protezione per le parti trattate.

Penetrating product containing high-lubricant, penetrating oil. Penetrates rust and corrosion to loosen screws, bolts and hinges, while leaving a coating for future protection.



SBLOCCANTE LUBRIFICANTE SPRAY

35200

- SBLOCCANTE LUBRIFICANTE SPRAY
- PENETRATING LUBRICANT
- DÉGRIPPANT LUBRIFIANT
- Schraubenlöser/Schmiermittel
- AFLOJA-LUBRICA ROSCAS



250 ml

MASTER 24

Rimuove viti, bulloni cerniere da ruggine e incrostazioni garantendo una futura protezione per le parti trattate.

Penetrates rust and corrosion to loosen screws, bolts and hinges, while leaving a coating for future protection.



SBLOCCANTE LUBRIFICANTE SPRAY

35201

- SBLOCCANTE LUBRIFICANTE SPRAY
- PENETRATING LUBRICANT
- DÉGRIPPANT LUBRIFIANT
- Schraubenlöser/Schmiermittel
- AFLOJA-LUBRICA ROSCAS



450 ml

MASTER 24

Rimuove viti, bulloni cerniere da ruggine e incrostazioni garantendo una futura protezione per le parti trattate.

Penetrates rust and corrosion to loosen screws, bolts and hinges, while leaving a coating for future protection.



GRASSO LUBRIFICANTE SPRAY

31387

- GRASSO LUBRIFICANTE
- LUBRICANT GREASE
- GRAISSE LUBRIFIANTE
- Schmierfett
- GRASA LUBRIFICANTE



250 ml

MASTER 24

Lubrifica tutti i tipi di catene di moto e biciclette formando una leggera pellicola, protegge la catena dall'ossidazione e dall'usura. Può essere applicato anche a freddo.

Lubricates all types of motorbike and bicycle chains. Leaves a light film to protect the chain against corrosion and wear. May be used on cold objects.



LIQUIDO FRENI DOT4

31376

- FLUIDO SINTETICO PER FRENI DOT4
- DOT4 BRAKE FLUID
- LIQUIDE FREINS DOT4
- Bremsflüssigkeit DOT4
- LÍQUIDO DE FRENOS DOT4



250 ml

MASTER 48

Fluido sintetico per freni ad alto punto d'ebollizione, per tutti i circuiti di frenaggio a disco o a tamburo. Indicato per auto, camion ecc.

Synthetic brake fluid with high boiling point for all types of disk and drum brakes. Recommended for cars, lorries, buses, etc.

LIQUIDO ROSSO RADIATORI

31371

- LIQUIDO ANTICONGELANTE ROSSO RADIATORI
- RED ANTIFREEZE RADIATOR LIQUID
- PRODUIT ANTIGEL PRÉ À L'EMPLOI POUR RADIATEURS
- GEBRAUCHSFERTLIGES FROSTSCHUTZMLTTEL FÜR KÜHLER
- ANTICONGELANTE PARA RADIADORES, LISTO PARA SU USO

1 Litro **-22°**

MASTER 12



Anticongelante per radiatori pronto all'uso, protegge dal gelo l'impianto di raffreddamento dell' auto fino ad una temperatura di -22°C. Contiene particolari inibitori di corrosione ecologici che ne consentono l'impiego anche in presenza di parti in alluminio. Da utilizzarsi anche in estate per aumentare il punto di ebollizione dell'acqua.

Permanent antifreeze liquid, ready for use, ensures protection down to - 22°C. Guarantees total protection of the cooling system of all types of vehicles, including those with engine parts made of aluminium other alloys. The presence of ecological corrosion inhibitors and antifoam agents always guarantees optimum working of the cooling system. May also be used in summer to raise the boiling point of the water.

LIQUIDO BLU RADIATORI

31372

- LIQUIDO ANTICONGELANTE BLU RADIATORI
- BLUE ANTIFREEZE RADIATOR LIQUID
- PRODUIT ANTIGEL PRÉ À L'EMPLOI POUR RADIATEURS
- GEBRAUCHSFERTLIGES FROSTSCHUTZMLTTEL FÜR KÜHLER
- ANTICONGELANTE PARA RADIADORES, LISTO PARA SU USO

1 Litro **-22°**

MASTER 12



Anticongelante per radiatori pronto all'uso, protegge dal gelo l'impianto di raffreddamento dell' auto fino ad una temperatura di -22°C. Contiene particolari inibitori di corrosione ecologici che ne consentono l'impiego anche in presenza di parti in alluminio. Da utilizzarsi anche in estate per aumentare il punto di ebollizione dell'acqua.

Permanent antifreeze liquid, ready for use, ensures protection down to - 22°C. Guarantees total protection of the cooling system of all types of vehicles, including those with engine parts made of aluminium other alloys. The presence of ecological corrosion inhibitors and antifoam agents always guarantees optimum working of the cooling system. May also be used in summer to raise the boiling point of the water.

LIQUIDO ROSSO RADIATORI

31373

- LIQUIDO ANTICONGELANTE ROSSO RADIATORI
- RED ANTIFREEZE RADIATOR LIQUID
- PRODUIT ANTIGEL PRÉ À L'EMPLOI POUR RADIATEURS
- GEBRAUCHSFERTLIGES FROSTSCHUTZMLTTEL FÜR KÜHLER
- ANTICONGELANTE PARA RADIADORES, LISTO PARA SU USO

5 Litri **-22°**

MASTER 4



Anticongelante per radiatori pronto all'uso, protegge dal gelo l'impianto di raffreddamento dell' auto fino ad una temperatura di -22°C. Contiene particolari inibitori di corrosione ecologici che ne consentono l'impiego anche in presenza di parti in alluminio. Da utilizzarsi anche in estate per aumentare il punto di ebollizione dell'acqua.

Permanent antifreeze liquid, ready for use, ensures protection down to - 22°C. Guarantees total protection of the cooling system of all types of vehicles, including those with engine parts made of aluminium other alloys. The presence of ecological corrosion inhibitors and antifoam agents always guarantees optimum working of the cooling system. May also be used in summer to raise the boiling point of the water.

LIQUIDO BLU RADIATORI

31374

- LIQUIDO ANTICONGELANTE BLU RADIATORI
- BLUE ANTIFREEZE RADIATOR LIQUID
- PRODUIT ANTIGEL PRÉ À L'EMPLOI POUR RADIATEURS
- GEBRAUCHSFERTLIGES FROSTSCHUTZMLTTEL FÜR KÜHLER
- ANTICONGELANTE PARA RADIADORES, LISTO PARA SU USO

5 Litri **-22°**

MASTER 4



Anticongelante per radiatori pronto all'uso, protegge dal gelo l'impianto di raffreddamento dell' auto fino ad una temperatura di -22°C. Contiene particolari inibitori di corrosione ecologici che ne consentono l'impiego anche in presenza di parti in alluminio. Da utilizzarsi anche in estate per aumentare il punto di ebollizione dell'acqua.

Permanent antifreeze liquid, ready for use, ensures protection down to - 22°C. Guarantees total protection of the cooling system of all types of vehicles, including those with engine parts made of aluminium other alloys. The presence of ecological corrosion inhibitors and antifoam agents always guarantees optimum working of the cooling system. May also be used in summer to raise the boiling point of the water.



IGIENIZZANTE CLIMA

31716

- SBLOCCANTE LUBRIFICANTE SPRAY
- PENETRATING LUBRICANT
- DÉGRIPPANT LUBRIFIANT
- Schraubenlöser/Schmiermittel
- AFLOJA-LUBRICA ROSCAS

200 ml

MASTER 24



Antiodore per condizionatori d'aria. Elimina i cattivi odori dell'impianto dell'aria condizionata. Igienizza l'ambiente e profuma l'abitacolo.

Perfumed air freshener for air conditioners. Removes the foul smells from the air conditioner. Sanitizes the environment and scents the vehicle interiors.



ESTINTORE SPRAY

31520

- ESTINTORE SPRAY ADATTO PER SPEGNERE PICCOLI FUOCHI
- SPRAY EXTINGUISHER
- EXTINCTEUR
- Feuerlöscher
- EXTINTOR



450 ml

MASTER 12



Viene utilizzato per domare gli incendi sulle auto, sulle barche, negli uffici, nelle case, ecc. Non è tossico, non è dannoso per l'ambiente e neanche macchiante. Può essere utilizzato per estinguere l'attrezzatura elettrica con voltaggio fino a 1000V dalla distanza di 1 metro.

Ideal for extinguishing cars, boats, offices, houses, etc. Nontoxic, environment-friendly, stain-resistant. Can be used to extinguish fires, including electric equipment up to 1000V in distance 1 m.



ESTINTORE SPRAY

35196

- ESTINTORE SPRAY ADATTO PER SPEGNERE PICCOLI FUOCHI
- SPRAY EXTINGUISHER
- EXTINCTEUR
- Feuerlöscher
- EXTINTOR



1000 ml

MASTER 12



Viene utilizzato per domare gli incendi sulle auto, sulle barche, negli uffici, nelle case, ecc. Non è tossico, non è dannoso per l'ambiente e neanche macchiante. Può essere utilizzato per estinguere l'attrezzatura elettrica con voltaggio fino a 1000V dalla distanza di 1 metro.

Ideal for extinguishing cars, boats, offices, houses, etc. Nontoxic, environment-friendly, stain-resistant. Can be used to extinguish fires, including electric equipment up to 1000V in distance 1 m.



LAVAVETRI PLURISTAGIONALE

31350

- LAVAVETRI PLURISTAGIONALE
- WINDSCREEN LIQUID DETERGENT
- LIQUIDE PARE-BRISE
- FLÜSSIGKEIT WIDSCHUTZSCHEIBE
- LÌQUIDO LIMPIA PARABRISAS



250 ml

MASTER 48

Basta versare il liquido nella vaschetta lavavetri e aggiungere 3 lt. d'acqua e la pulizia del parabrezza sarà perfetta.

It is enough to pour it into the glass cleaner tank, add 3 litres water and the windscreen cleaning will be perfect.



LIQUIDO VASCHETTA TERGI

31440

- LAVAVETRI INVERNALE -40°C
- WINDSCREEN LIQUID DETERGENT -40°C
- LIQUIDE PARE-BRISE -40° HIVALNAL
- Flüssigkeit Widschutzscheibe -40° Winterlich
- LÌQUIDO LIMPIA PARABRISAS -40° INVERNAL



250 ml

MASTER 48

-40°

Aggiunto alla vaschetta dell'impianto lavavetri abbassa il punto di congelamento dell'acqua nella stagione invernale ne permette il perfetto funzionamento garantendo una perfetta visibilità.

Add it in the windscreen fluid tank of the car to reduce the water freezing level during the winter season: it will grant a perfect visibility for greater safety.



WINTER

LAVAVETRI PARABREZZA

31357

- LIQUIDO DETERGENTE PER VASCHETTA TERGI
- CITRUS-SCENTED WINDSCREEN WASHER FLUID
- LIQUIDE POUR BAC LAVE-GLACE
- FLÜSSIGKEIT FÜR DIE SCHEIBENWASCHANLAGE
- LÌQUIDO LIMPIA CRISTALES



5 Litri

MASTER 4



Liquido detergente per vaschetta tergi vetro aromatizzato al Limone, per una perfetta pulizia di tutti i parabrezza di auto, furgoni e camion.

Citrus-scented windscreen washer fluid.





SHAMPOO & CERA AUTO

31700

- SHAMPOO AUTO LUCIDANTE CON CERA
- SHAMPOO CAR
- SHAMPOING VOITURE
- Autoshampoo
- CHAMPÚ DE COCHES



- Lucida
- Protegge
- Sgrassa
- Antistatico
- Deterge

1 Litro

MASTER 12



Con un'unica operazione deterge a fondo, ravviva la carrozzeria e stende una sottile pellicola lucida di cera che protegge nel tempo la vernice della vostra auto.

With this one you will get a perfect cleaning, a brighter body and a thin and long lasting paint protective wax layer.

SHAMPOO DETERGENTE

31705

- SHAMPOO DETERGENTE PER AUTO
- SHAMPOO CAR
- SHAMPOING VOITURE
- Autoshampoo
- CHAMPÚ DE COCHES

1 Litro

MASTER 12



La sua formula innovativa deterge e ravviva la superficie della vostra auto lasciandola splendente e senza aloni. Indicato per lavaggi frequenti.

The new special formula cleans and renews the body of your car, giving a shiny finish without marks. Suitable for frequent washings.

SHAMPOO DETERGENTE

31710

- SHAMPOO DETERGENTE PER AUTO
- SHAMPOO CAR
- SHAMPOING VOITURE
- Autoshampoo
- CHAMPÚ DE COCHES

5 Litri

MASTER 4



La sua formula innovativa deterge e ravviva la superficie della vostra auto lasciandola splendente e senza aloni. Indicato per lavaggi frequenti.

The new special formula cleans and renews the body of your car, giving a shiny finish without marks. Suitable for frequent washings.

PULITORE INTERNI TESSUTI E PELLI

31718

- PULITORE INTERNI, TESSUTI E TAPPETI
- TEXTILE UPHOLSTERY AND CARPETS CLEANER
- NETTOYANT INTÉRIEUR, LES TISSUS ET LES TAPIS
- Reiniger Interieur, Stoffe und Teppiche
- INTERIORES MÁS LIMPIAS, TELAS Y ALFOMBRAS

650 ml

MASTER 24



Schiuma attiva per eliminare lo sporco da sedili, superfici in tessuto e rivestimenti in moquette. Non bagna e si rimuove facilmente, lasciando un gradevole profumo. Ravviva i colori e non necessita risciacquo.

Active foam for eliminating dirt from fabric car seats and surfaces as well as carpeted coverings. Does not wet fabrics and it is simple to remove, leaving a pleasant perfume. Revives colours and does not require rinsing.



CON SPAZZOLA

TESSUTI E MOQUETTE

31703

- DETERGENTE TESSUTI E MOQUETTE
- UPHOLSTERY AND MOQUETTE MATS DETERGENT
- REMBOURRAGE ET MOQUETTE TAPIS DÉTERGENT
- Polster und Moquette Mats Waschmittel
- TAPICERÍA Y ALFOMBRILLAS DETERGENTE MOQUETTE

750 ml

MASTER 12



Tessuti naturali e sintetici - Elimina lo sporco - Protegge - Ravviva i colori.

Upholstery and moquette mats detergent.



LUCIDA CRUSCOTTI

31719

- LUCIDA CRUSCOTTI EFFETTO LUCIDO
- PROFESSIONAL DASHBOARD POLISHER
- POLISSEUR TABLEAUX DE BORDS
- Cockpit-Politur
- LIMPIASALPICADEROS



Lucida

Rinnova

Anti UV

Protegge

Deterge

650 ml

MASTER 24



Ridona brillantezza a tutte le superfici plastiche di auto e moto. Non contiene abrasivi.

Restores the shiny surface of the plastic areas of cars and motorcycles. It doesn't contain abrasives.

effetto lucido

LUCIDA CRUSCOTTI SATINATO

31720

- LUCIDA CRUSCOTTI EFFETTO SATINATO
- PROFESSIONAL SATINATED DASHBOARD POLISHER
- TABLEAU DE BORD MAT
- Nicht glaenzend Armaturenbrell Poliermittel
- CUADRO DE MANDO OPACO



Pulisce

Non unge

Anti UV

Antistatico

Protegge

650 ml

MASTER 24



Ridona brillantezza a tutte le superfici plastiche di auto e moto. Non contiene abrasivi.

Restores the shiny surface of the plastic areas of cars and motorcycles. It doesn't contain abrasives.

effetto opaco

VETRI E CRISTALLI

31704

- DETERGENTE PER VETRI E CRISTALLI
- GLASS DETERGENT
- DÉTERGENT POUR VITRES
- Reinigungsmittel für Glas
- DETERGENTE PARA VIDRIOS

750 ml

MASTER 12



Pulisce a fondo vetri e cristalli senza lasciare aloni. Rende la superficie brillante e profumata.

Thoroughly cleans glass and windows without leaving streaks. Leaves the surface bright and lint free.





GONFIA E RIPARA PNEUMATICI

96295

- GONFIA E RIPARA PNEUMATICI
- TUBE REPAIR SPRAY 100 ML
- RÉPARATION DE PNEUS ET DE L'INFLATION
- Reifenreparatur und Inflation
- DE REPARACIÓN DE NEUMÁTICOS Y LA INFLACIÓN



100 ml

MASTER 24 **PER BICICLETTA**

Prodotto di emergenza. In caso di foratura del pneumatico, permette di poter raggiungere il centro di assistenza più vicino. Pratico e funzionale renderà più sicuri i vostri viaggi.

Inflates and repairs for Emergencies. In the case of tyre punctures, this will allow you to reach the nearest assistance centre. Practical and easy to use, makes your journeys safer.



LUBRIFICANTE SPECIALE PER CATENE

96296N

- LUBRIFICANTE SPECIALE PER CATENE 250ml
- CHAIN LUBRICANT 250ml
- 250ml LUBRIFIANT DE LA CHAÎNE
- Kette Schmierem 250ml
- CADENA LUBRIFICANTE 250ml



250 ml

MASTER 24 **PER MOTO E BICICLETTE**

Contiene oli ad elevato potere lubrificante e penetrante. Garantendo una futura protezione per le catene trattate.

Penetrating product containing high-lubricant, penetrating oil. While leaving a coating for chain protection.



GONFIA E RIPARA PNEUMATICI MOTO

60719

- GONFIA E RIPARA PNEUMATICI MOTO
- MOTORCYCLE TYRE REPAIR
- RÉPARATION DE PNEUS ET DE L'INFLATION
- Reifenreparatur und Inflation
- DE REPARACIÓN DE NEUMÁTICOS Y LA INFLACIÓN



**GONFIA E RIPARA
 PNEUMATICI
 DA MOTO E SCOOTER**

450 ml

MASTER 24

Prodotto di emergenza. In caso di foratura del pneumatico, permette di poter raggiungere il centro di assistenza più vicino. Pratico e funzionale renderà più sicuri i vostri viaggi.

Inflates and repairs for Emergencies. In the case of tyre punctures, this will allow you to reach the nearest assistance centre. Practical and easy to use, makes your journeys safer.



PANNO GIALLO

32102

- PANNO GIALLO 2 PEZZI AUTO
- YELLOW WOOL 2 PCS CAR
- JAUNE LAINE 2 PIÈCES VOITURE
- GELB WOLLE 2 Stück Auto
- YELLOW WOOL 2 PIEZAS DE COCHE



2 pezzi

MASTER 72



2 DAINELLA

32129

- PELLE SINTETICA SCAMOSCIATA NATURALE
- SYNTHETIC CHAMOIS LEATHER
- PEAU DE CHAMOIS SYNTHETIQUE
- Kunstwildledertuch
- GAMUZA PIEL SINTÉTICA



2 pezzi

MASTER 120 INNER 12

Il panno Dainella Tuttofare è realizzato con un'alta percentuale di fibre di origine naturale ad alto potere assorbente. Utilizzabile con qualsiasi detergente, non lascia pelucchi o aloni. Ideale per tutti i tipi di pulizia, auto, moto, furgoni, camion, barche, biciclette, cucina, bagno, mobili laccati, ecc...

The Dainella All-Purpose cloth is made with a high percentage of fibres of natural origin with a high absorbent capacity. Usable with any detergent, it is lint-free and leaves no rings. Ideal for all types of cleaning, kitchen, bathroom, lacquered furniture, etc...

36x40cm

DAINELLA

32126

- PELLE SINTETICA SCAMOSCIATA NATURALE
- SYNTHETIC CHAMOIS LEATHER
- PEAU DE CHAMOIS SYNTHETIQUE
- Kunstwildledertuch
- GAMUZA PIEL SINTÉTICA



MASTER 120 INNER 12



DAINO SPEED

32116

- 25 PANNI CATTURA POLVERE
- 25 CLOTH DUST CAPTURE
- 25 TISSU DUST CAPTURE
- 25 Tuch Stauberfassung
- 25 PAÑO DE POLVO DE CAPTURA



**PANNI CATTURA
 POLVERE
 ANTISTATICI**

MASTER 120 INNER 12





VERA PELLE

32062-32066-32074

- VERA PELLE SCAMOSCIATA NATURALE
- NATURAL GENUINE CHAMOIS LEATHER
- VÉRITABLE PEAU DE CHAMOIS NATURELLE
- Echtes Natur-Wildleder
- GAMUZA DE PIEL NATURAL



MASTER 36 INNER 12

CONCIATA ALL'OLIO



32062	cavaliere-header card	MEDIA
32066	cavaliere-header card	GRANDE
32074	cavaliere-header card	EXTRA GRANDE

PELLE ALCANTARA

32131

- ALCANTARA PELLE SINTETICA SCAMOSCIATA
- ALCANTARA SYNTHETIC CHAMOIS LEATHER
- ALCANTARA PEAU SYNTHÉTIQUE DE CHAMOIS
- Alcantara Kunstwildleder-Tuch
- ALCANTARA PIEL SINTETICA



MASTER 60 INNER 12

MISURA/SIZE 60X40 CM

ALCANTARA



32131 cavaliere-header card

SPUGNA DAINO

32111

- VERA PELLE SCAMOSCIATA NATURALE
- NATURAL GENUINE CHAMOIS LEATHER
- VÉRITABLE PEAU DE CHAMOIS NATURELLE
- Echtes Natur-Wildleder
- GAMUZA DE PIEL NATURAL



MASTER 600 INNER 60



MAGIC MICROFIBRA

32133

- PANNO IN MICROFIBRA
- CLOTH MICROFIBER SUEDE
- CHIFFON EN MICROFIBRES SUEDE
- Mikrofaser Suede
- PAÑO DE MICROFIBRA SUEDE

MASTER 24



SPUGNA LAVAGGIO

32262

- SPUGNA MULTIUSO PER LAVAGGIO
- MULTIPURPOSE SPONGE FOR WASHING
- ÉPONGE À USAGES MULTIPLES POUR LE LAVAGE
- Mehrzweck-Schwämme zum Waschen
- ESPONJA MULTIUSOS PARA EL LAVADO

MAXI



MASTER 200 INNER 25

FARFALLA

24x13,5x6,5

SPUGNA LAVAGGIO

32256

- SPUGNA MULTIUSO PER LAVAGGIO
- MULTIPURPOSE SPONGE FOR WASHING
- ÉPONGE À USAGES MULTIPLES POUR LE LAVAGE
- Mehrzweck-Schwämme zum Waschen
- ESPONJA MULTIUSOS PARA EL LAVADO



MASTER 300 INNER 25

OVALE

18x11x6

SPUGNA LAVAGGIO

32252

- SPUGNA MULTIUSO PER LAVAGGIO
- MULTIPURPOSE SPONGE FOR WASHING
- ÉPONGE À USAGES MULTIPLES POUR LE LAVAGE
- Mehrzweck-Schwämme zum Waschen
- ESPONJA MULTIUSOS PARA EL LAVADO

ORIGINALE TEDESCA



MASTER 384 INNER 24



KITTY GRANDE

15,5x12x6

SPUGNA LAVAGGIO

32254

- SPUGNA MULTIUSO PER LAVAGGIO
- MULTIPURPOSE SPONGE FOR WASHING
- ÉPONGE À USAGES MULTIPLES POUR LE LAVAGE
- Mehrzweck-Schwämme zum Waschen
- ESPONJA MULTIUSOS PARA EL LAVADO

ORIGINALE ITALIANA



MASTER 400 INNER 25



RETTANGOLARE

15x11x7

SPUGNA LAVAGGIO

32250

- SPUGNA MULTIUSO PER LAVAGGIO
- MULTIPURPOSE SPONGE FOR WASHING
- ÉPONGE À USAGES MULTIPLES POUR LE LAVAGE
- Mehrzweck-Schwämme zum Waschen
- ESPONJA MULTIUSOS PARA EL LAVADO

ORIGINALE TEDESCA



MASTER 480 INNER 30



KITTY

13,5x10x6



HYDROBRUSH

32236

- IDROSPAZZOLA PER LAVAGGIO AUTO, CAMION, CAMPER, CON SETOLE SINTETICHE. CONSENTE DI EFFETTUARE UNA PULIZIA PROFONDA RIMUOVENDO LO SPORCO PIÙ OSTINATO E RISPETTANDO, CONTEMPORANEAMENTE LA VERNICIATURA DEL MEZZO.
- WATER BRUSH FOR WASHING CARS, TRUCKS, CAMPERS WITH SYNTHETIC BRISTLES. ALLOWS A THOROUGH CLEANING BY REMOVING STUBBORN DIRT WHILE NOT DAMAGING THE VARNISH.
- BROSE POUR LAVAGE AVEC DES POILS SYNTHÉTIQUES
- Hydrobürste für die Autowäsche mit synthetischen Borsten
- HIDROCEPILLO PARA LAVADO CON CERDAS SINTÉTICAS



MASTER 30 INNER 10

HYDROHANDLE

32237

- MANICO PER IDROSPAZZOLA CON IMPUGNATURA ERGONOMICA
- WATER BRUSH STICK WITH ERGONOMICAL HANDLE
- MANCHE POUR BROSE AVEC PRÉHENSION ERGONOMIQUE
- Spritzlanze für Hydrobürste mit ergonomischem Handgriff
- MANGO PARA HIDROCEPILLO CON EMPUÑADURAS ERGONÓMICAS



TELESCOPICO-TELESCOPIC
140÷280cm

MASTER 30 INNER 10

ESPO

32238

- ESPOSITORE PER ARTICOLI 32236-32237
- EXHIBITOR FOR ARTICLES 32236-32237
- EXPOSANT POUR LES ARTICLES 32236-32237
- Aussteller für Artikel 32236-32237
- EXPOSITOR PARA ARTÍCULOS 32236-32237



CONTIENE 10 SPAZZOLONI

CONTAINS 10 BRUSHES

MANICI IDROCAR

32230-32234

- MANICO PER IDROSPAZZOLA CON IMPUGNATURA ERGONOMICA
- WATER BRUSH STICK WITH ERGONOMICAL HANDL
- MANCHE POUR BROSE AVEC PRÉHENSION ERGONOMIQUE
- Spritzlanze für Hydrobürste mit ergonomischem Handgriff
- MANGO PARA HIDROCEPILLO CON EMPUÑADURAS ERGONÓMICAS



32230	180 cm	
32234	100>200 cm	TELESCOPICO-TELESCOPIC

MASTER 12

IDROCAR PVC

32210

- IDROSPAZZOLA CON SETOLA SINTETICA
- SYNTHETIC HYDRO BRUSH
- BROSSE DE LAVAGE AVEC SOIE SYNTHETIQUE
- Autowaschbürste aus synthetischen Borsten
- CEPILLO DE LAVADO SINTETICO PVC

MASTER 12



IDROCAR CRINE

32212

- IDROSPAZZOLA CON SETOLA IN CRINE
- HORSEHAIR HYDRO BRUSH
- BROSSE DE LAVAGE AVEC SOIE EN CRIN
- Autowaschbürste aus Rosshaarborsten
- CEPILLO DE LAVADO CERDAS

MASTER 12



PULIVETRO

32142 - 32143

- PULIVETRO CM 25 CON MANICO E SPUGNA PULISCI MOSCERINI
- CM 25 GLASS CLEANER WITH HANDLE WITH SPONGE FOR MIDGES
- RACLETTE DE LAVAGE CM 25 AVEC MANCHE ET ÉPONGE RECOUVERTE DE FILETS POUR ÉLIMINER LES MOUCHES
- Fensterwischer cm 25 mit langem griff und mit schwamm zum entfernen von insekten
- RASQUETA CRISTALES CM 25 CON MANGO Y ESPONJA LIMPIA INSECTOS

manico 40 cm

Art. 32142

manico 27,5 cm Art. 32143

PROFESSIONALE



GOMMA ALTA QUALITA',
SPUGNA MAGGIORE DENSITA'

32142	manico 40 cm	MASTER 50
32143	manico 27,5 cm	MASTER 50

PULIVETRO

32144

- PULIVETRO CON SPUGNA PULISCI MOSCERINI
- GLASS CLEANER WITH SPONGE FOR MIDGES
- ACLETTE DE LAVAGE CM 25 AVEC ÉPONGE RECOUVERTE DE FILETS POUR ÉLIMINER LES MOUCHES
- Fensterwischer mit Schwamm zum entfernen von Insekten
- RASQUETA CRISTALES CON ESPONJA LIMPIA MOSQUITOS

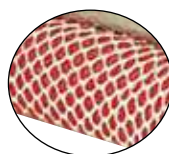

MASTER 48 INNER 12





RASCHIAGHIACCIO CON GUANTO

32314

- RASCHIAGHIACCIO CON GUANTO
- ICE-SCRAPER WITH GLOVE
- RACLETTE ANTI GIVRE AVEC GANT
- Schwarzes Schütteln mit Handschuh
- RASQUETA QUITAHIELOS CON EL GUANTE



MASTER 96 INNER 24

RASCHIAGHIACCIO

32316

- RASCHIAGHIACCIO IN COLORI ASSORTITI
- ICE-SCRAPER IN ASSORTED COLOURS
- RACLETTE ANTI GIVRE AVEC COULEURS ASSORTIES
- Eisschaber in verschiedenen Farbenn
- RASQUETA QUITAHIELOS EN COLORES SURTIDOS



MASTER 400 INNER 50

RASCHIAGHIACCIO

32323

- RASCHIAGHIACCIO
- ICE SCRAPER
- RACLETTE ANTI GIVRE
- Eisschaber
- RASQUETA QUITAHIELOS



MASTER 96 INNER 24

DEGHIACCIANTE SPRAY

77890

- DEGHIACCIANTE SPRAY
- ICE REMOVER
- DÉCAPANT DE GLACE
- Eisentferner
- REMOVER HIELO



Elimina all'istante ghiaccio, neve e brina da parabrezza e vetri. Scongela serrature e pinze freni. Non intacca la plastica e le guarnizioni.

Nstantly eliminates ice and frost from windscreens and glass. Defrosts locks, brakes, springs. Does not effect rubber or plastic sealings.



NO GHIACCIO

250 ml

MASTER 24



DEGHIACCIANTE SPRAY

77891

- DEGHIACCIANTE SPRAY
- ICE REMOVER
- DÉCAPANT DE GLACE
- Eisentferner
- REMOVER HIELO

NO GHIACCIO

450 ml

MASTER 24



Elimina all'istante ghiaccio, neve e brina da parabrezza e vetri. Scongela serrature e pinze freni. Non intacca la plastica e le guarnizioni.

Instantly eliminates ice and frost from windscreens and glass. Defrosts locks, brakes, springs. Does not effect rubber or plastic sealings.





ASPIRAPOLVERE

77356

- ASPIRAPOLVERE 12V 60 W
- 12V 60 W – VACUUM CLEANER
- 12V 60 W – ASPIRATEUR
- 12V 60 W – Staubsauger
- 12V 60 W – ASPIRADORA



Mantiene l'interno della tua automobile pulito ed elimina polvere e fango.

Keep your car interior always tidy from dirty dust and mud.

12V **60W**

MASTER 24



ASPIRAPOLVERE

30067

- ASPIRAPOLVERE 12V 60 W
- 12V 60 W – VACUUM CLEANER
- 12V 60 W – ASPIRATEUR
- 12V 60 W – Staubsauger
- 12V 60 W – ASPIRADORA



Mantiene l'interno della tua automobile pulito ed elimina polvere e fango.

Keep your car interior always tidy from dirty dust and mud.

12V **60W**

MASTER 24



MAXI CLEANER

30066

- ASPIRAPOLVERE 12V 80 W
- 12V 80 W – VACUUM CLEANER
- 12V 80 W – ASPIRATEUR
- 12V 80 W – Staubsauger
- 12V 80 W – ASPIRADORA



- ✓ Pratica conservazione del cavo dopo l'uso
- ✓ Convenience to keep the cord after used

Mantiene l'interno della tua automobile pulito ed elimina polvere e fango.

Keep your car interior always tidy from dirty dust and mud.

MASTER 12

COPRIAUTO IN NYLON ANTISTRAPPO

18291S/M-18294L/XL

- COPRIAUTO IN NYLON ANTISTRAPPO. COMPLETO DI BORSA PER CUSTODIA E TRASPORTO. IMPERMEABILE ED INATTACCABILE DAGLI AGENTI ATMOSFERICI. PRODOTTO DI ALTA QUALITÀ.
- ANTITEAR NYLON CAR COVER WITH BAG. WATERPROOF AND RESISTANT TO THE BAD WEATHER. HIGH QUALITY PRODUCT.
- HOUSSE AUTO EN NYLON CONTRE-COUP, AVEC BOITIER.
- Autoplane aus nylon, reissfest, komplett mit aufbewahr- und tragetasche.
- FUNDA CUBREAUTO DE NYLON. DOTADA DE UNA BOLSA PARA GUARDARLA Y TRANSPORTARLA. IMPERMEABLE Y RESISTENTE A LOS AGENTES ATMOSFERICOS. PRODUCTO DE ALTA CALIDAD.



18291S/M	433X166X116CM
18294L/XL	520X191X116CM

☐ PER VERIFICARE LA COMPATIBILITÀ CON IL PROPRIO VEICOLO CONSULTARE LA TABELLA APPLICATIVA A PAGINA 81

SUPER GENIUS FELPATO

18355-18356-18357-18358-18359

- COPRIAUTO FELPATO MASTER 4
- CAR COVER
- HOUSSE DE VOITURE
- Autoabdeckung
- CUBIERTA PARA COCHE

PROTEGGE LA VOSTRA AUTO IN OGNI STAGIONE:
DAL SOLE PERCHÉ MANTIENE L'ABITACOLO FRESCO;
DAI CLIMI UMIDI E GHIACCIATI PERCHÉ RESISTE ALL'UMIDITÀ.
ESSENDO UN PRODOTTO DI ALTA QUALITÀ NON SI DETERIORA NEL TEMPO.

IT PROTECTS YOUR CAR IN EACH SEASON:
FROM SUN BECAUSE IT KEEPS THE INTERIOR COOL.
FROM WET AND ICY CLIMATE BECAUSE IT STANDS HUMIDITY
VERY HIGH QUALITY PRODUCT, IT DOESN'T DETERIORATE WITH TIME.

RESISTENTE AI RAGGI UV DEL SOLE ED AL CALORE
SUPER ROBUSTO - IMPERMEABILE
CUCITURE DOPPIE
CON PRATICI GANCI DI FISSAGGIO

UV SUN RAYS AND HEAT RESISTANT
SUPER STRONG - WATER PROOF
DOUBLE STICHES
WITH PRACTICAL FIXING HOOKS

18355	S SMALL	per vetture compatte e city car dei segmenti A e B con lunghezza sino a 405cm (es: FIAT PUNTO, FORD FIESTA, FIAT 500...)
18356	M MEDIUM	per vetture a due volumi medie, monovolumi compatti, SUV compatti, berline compatte con lunghezza sino a 430cm (es: VW GOLF, MERCEDES CLASSE A, ALFA GIULIETTA, FIAT 500X..)
18357	L LARGE	per vetture a due e tre volumi medio grandi, monovolumi medi, SW medio grandi SUV medi con lunghezza sino a 470cm (es: MERCEDES CLASSE C, BMW SERIE 3, OPEL ASTRA SW...)
18358	XL EXTRA LARGE	per vetture e SW a tre volumi grandi, monovolume grandi, SUV e fuoristrada medio grandi, MiniVAN con lunghezza sino a 490cm (es: BMW SERIE 5, OPEL INSIGNA, AUDI A6, ALFA GIULIA, AUDI Q5...)
18359	XXL EXTRA EXTRA LARGE	per ammiraglie grandissime, monovolumi grandi, SUV, PICK UP e Fuoristrada grandi, VAN medio grandi con lunghezza sino a 520cm (es: MERCEDES S, BMW SERIE 7, JEEP GRAND CHEROKEE...)



SUPER GENIUS



NOVITÀ

RESISTENTE AI RAGGI UV DEL SOLE
UV-SUN RAY RESISTANT



**SUPER ROBUSTO
LAVABILE e IMPERMEABILE
CON PRATICI GANCI
DI FISSAGGIO**



ESTERNO IN PVC + MORBIDA IMBOTTITURA INTERNA DI COTONE E POLIPROPILENE ANTIGRAFFIO
Pvc outside + soft non scratch cotton and polypropilen material inside

■ PER VERIFICARE LA COMPATIBILITÀ CON IL PROPRIO VEICOLO CONSULTARE LA TABELLA APPLICATIVA A PAGINA 81

TELO ANTIGRANDINE PER AUTO

77470-77472-77474

- TELO ANTIGRANDINE PER AUTO
- ANTI HAIL CAR COVER
- TELE ANTIGRANDINE AUTO
- Anti Hagel Auto Abdeckung
- CUBIERTA DE COCHE ANTI GRANIZO

RIVESTIMENTO ESTERNO IN ROBUSTO FILM DI ALLUMINIO
SPessa IMBOTTITURA (6MM) IN PULIUERATANO ESPANSO ANTI-IMPATTO
MORBIDISSIMO TESSUTO-NON-TESSUTO ANTIGRAFFIO ALL'INTERNO
2 CINGHIE REGOLABILI IN ROBUSTO NYLON PER FISSAGGIO
SOTTOSCOCCA CON SISTEMA A GANCI RAPIDI
PANNELLI LATERALI IN MORBIDO TESSUTO- NON-TESSUTO
PRATICI ELASTICI ANTERIORI E POSTERIORI PER FISSAGGIO
SOTTO-PARAURTI UNIVERSALE ED ANTIVENTO

*Strong External Aluminum layer
6mm thick EPU anti-impact layer
Super soft non woven inner layer
2 adjustable nylon belts with underbody fasteners system
Elasticated front and back ends for a steady and windproof fastening*

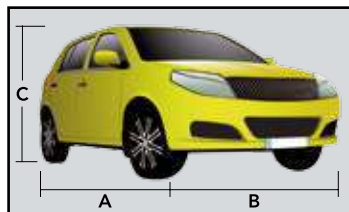

ARTICOLO	TAGLIA	VETURE	A B C
77470	S-small	Per vetture compatte e city car dei segmenti A e B <i>For compact and city cars</i>	cm 406x165x119
77472	M/L-medium/ large	Per berline e due-volumi medio-grandi dei segmenti C e D, Station Wagons compatte, SUV Compatti <i>For MidSize Sedans and Hatchbacks, compact SUV and wagons</i>	cm 482x178x119
77474	XL-xtra large	Per vetture grandi del segmento E, SUV, PickUp, MiniVan e Station Wagons <i>For full size Sedans and Hatchbacks, SUVs, PickUps, Mini Vans and Station Wagons</i>	cm 533x178x119

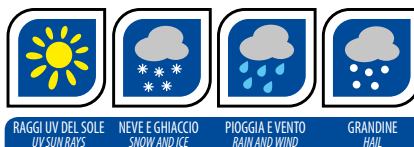

TESSUTO ANTIGRAFFIO ALL'INTERNO
Super soft non woven inner layer

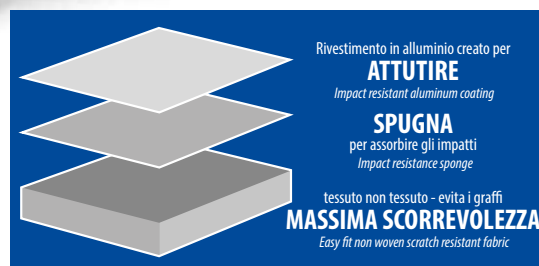

GOODYEAR

■ PER VERIFICARE LA COMPATIBILITÀ CON IL PROPRIO VEICOLO CONSULTARE LA TABELLA APPLICATIVA A PAGINA 81



MODELLO AUTO	18355	18356	18357	18358	18359	18291	18294	77470	77472	77474
MISURA	405x165x116	430x165x116	470x165x116	490x178x116	520x191x116	433x166x116	520x191x116	406x165x119	482x178x119	533x178x119
ABARTH										
500/500C	x					x		x		
Punto		x				x		x		
124 Spider		x				x			x	
ALFA ROMEO										
Mito		x				x		x		
Giulietta			x				x		x	
Giulia				x			x		x	
Stelvio				x			x		x	
4C	x					x		x		
33-145		x				x			x	
146-155-156			x				x		x	
Spider-GTV-75			x				x		x	
164-166				x			x		x	
33 Sport W-156 SW			x				x		x	
147		x					x		x	
159				x			x		x	
GT			x				x		x	
Brera			x				x		x	
159 SW				x			x		x	
AUDI										
A1	x					x		x		
Q2		x				x			x	
Q3			x				x		x	
Q5				x			x		x	
A2	x					x		x		
A5				x			x		x	
A6-S6- A8-S8-100					x		x			x
A6 Avant S6 Avant 100 Avant A6 All Road					x		x			x
A3 S3 Sportback			x				x		x	
A4 Avant 80 Avant			x				x		x	
A4 Coupè Cabriolet			x				x		x	
A7				x			x		x	
A8					x		x			x
TT TT Roadster		x				x			x	
Q7					x		x			x
AUTOBIANCHI										
Y10-A112	x					x		x		
BMW										
i3		x				x			x	
i8				x			x		x	
X1			x				x		x	
X2			x				x		x	
Serie 4 G Coupe				x			x		x	
X4				x			x		x	
X6					x		x			x

MODELLO AUTO	18355	18356	18357	18358	18359	18291	18294	77470	77472	77474
MISURA	405x165x116	430x165x116	470x165x116	490x178x116	520x191x116	433x166x116	520x191x116	406x165x119	482x178x119	533x178x119
Serie 5-M5										
Serie 5 Touring				x			x			x
GT										
X5					x		x			x
Serie 2 Active			x				x		x	
Tourer										
Serie 7-Serie 7L					x		x			x
Serie 3			x				x		x	
Compact										
Coupè-Cabrio										
Serie 3 Touring				x			x		x	
Z3-Z3 Coupè		x				x			x	
Z4-Z8			x				x		x	
Serie 1			x				x		x	
Serie 6				x			x			x
X3				x			x		x	
CHEVROLET										
Spark	x					x		x		
Aveo		x				x		x		
Cruze/sw			x				x		x	
Trax			x				x		x	
Captiva				x			x			x
Matiz	x					x		x		
Lanos		x				x			x	
Lacetti			x				x		x	
Chrysler										
Neon-Viper			x				x		x	
Stratus				x			x		x	
Stratus Cabrio										
PT Cruiser			x				x		x	
Sebring				x			x			x
300C					x		x			x
Voyager					x		x			x
Grand Voyager					x		x			x
CITROËN										
C3 Picasso		x				x			x	
DS3	x					x		x		
DS4			x				x		x	
DS5				x			x		x	
C5				x			x		x	
Nemo		x				x			x	
C3		x				x		x		
C 3 Aircross			x				x		x	
ZX		x				x			x	
Xsara-Xantia			x				x		x	
Xsara										
Berlina-SW.			x				x		x	
C5-XM				x			x		x	
C5 SW.-Xantia										
SW.				x			x		x	
C8-XM SW.					x		x			x
Berlingo										
Picasso			x				x		x	
Zx SW.				x			x		x	
C1	x					x		x		
C2	x					x		x		



MODELLO AUTO	18355	18356	18357	18358	18359	18291	18294	77470	77472	77474
MISURA	405x165x116	430x165x116	470x165x116	490x178x116	520x191x116	433x166x116	520x191x116	406x165x119	482x178x119	533x178x119
C3 Pluriel		x				x			x	
C4			x				x		x	
C4 Coupè			x				x		x	
C4 Picasso				x			x		x	
C 4 Cactus			x				x		x	
C4 Grand Picasso				x			x		x	
C6					x		x			x
C8					x		x			x
DACIA										
Sandero		x				x		x		
Logan			x				x		x	
Duster			x				x		x	
Lodgy			x				x		x	
Dokker			x				x		x	
DAEWOO										
Matiz-Kalos	x					x		x		
Lanos										
Nexia-Nubira			x				x		x	
Tacuma				x			x		x	
Evanda			x				x		x	
Nubira SW.			x				x		x	
Lacetti			x				x		x	
DAIHATSU										
Cuore	x					x		x		
YRV -Cuore	x					x		x		
Sirion move										
Trevis	x					x		x		
Materia		x				x			x	
Copen	x					x		x		
Terios		x				x			x	
DR										
DR1	x					x		x		
DR2	x					x		x		
DR5			x				x		x	
DS										
3	x					x		x		
4			x				x		x	
5				x			x		x	
7 CROSS BACK				x			x		x	
FIAT										
124 Spider		x				x			x	
500/500C	x					x		x		
500L			x			x			x	
500X			x				x		x	
Qubo		x				x			x	
Freemont					x		x			x
Panda Uno-600	x					x		x		
Punto	x					x		x		
Palio-Palio Weekend SW.		x				x			x	
Tipo-Brava Bravo-Barchetta		x				x			x	
Tipo SW			x				x		x	

MODELLO AUTO	18355	18356	18357	18358	18359	18291	18294	77470	77472	77474
MISURA	405x165x116	430x165x116	470x165x116	490x178x116	520x191x116	433x166x116	520x191x116	406x165x119	482x178x119	533x178x119
Coupè Marea-Tempra			x				x		x	
Croma (Vecchia)				x			x		x	
Multipla-Ulysse				x			x		x	
Marea SW.				x			x		x	
Doblò			x				x		x	
Stilo-Stilo Multiwagon			x				x		x	
Nuova Panda	x					x		x		
Grande Punto		x				x			x	
Idea		x				x			x	
Sedici			x				x		x	
Nuova Bravo			x				x		x	
Nuova Croma				x			x		x	
FORD										
B-Max			x				x		x	
Kuga				x			x		x	
KA-Fiesta I/II/III-Puma	x					x		x		
Ecosport		x				x		x		
Edge					x		x			x
Fiesta (>9/02)		x				x			x	
Galaxy Ranger					x		x			x
Mondeo Mondeo SW				x			x			x
Scorpio-Scorpio SW				x			x			x
Escort SW			x				x		x	
Focus			x				x		x	
Focus SW			x				x		x	
Focus Coupè Cabrio			x				x		x	
Maverick			x				x		x	
Mustang				x			x		x	
Tourneo Courier			x				x		x	
Tourneo Connect			x				x		x	
S-Max					x		x			x
C-Max			x				x		x	
GREAT WALL										
Steed 6				x			x			x
Hoover				x			x			x
HONDA										
Logo	x					x		x		
Jazz-Civic-Stream-Integra			x				x		x	
Legend				x			x			x
Civic SW.			x				x		x	
Accord-Accord Coupè-Tourer				x			x		x	
Prelude-S-NSX - HRV				x			x		x	
Civic		x				x			x	



MODELLO AUTO	18355	18356	18357	18358	18359	18291	18294	77470	77472	77474
MISURA	405x165x116	430x165x116	470x165x116	490x178x116	520x191x116	433x166x116	520x191x116	406x165x119	482x178x119	533x178x119
Civic Hybrid			x				x		x	
FRV				x			x		x	
CRV				x			x		x	
HRV			x				x		x	
HYUNDAI										
i10	x					x		x		
i20		x				x			x	
ix20		x				x			x	
i30			x				x		x	
i40				x			x		x	
ix35				x			x		x	
Ioniq			x				x		x	
Kona			x				x		x	
Santa Fe					x		x			x
Veloster		x				x			x	
Atos-Atos Prime	x					x		x		
Getz-Pony	x					x		x		
Accent-Elantra			x				x		x	
Tucson			x				x		x	
INFINITI										
Q30-QX30			x				x		x	
Q50				x			x		x	
FX-QX70					x		x			x
JAGUAR										
E Pace			x				x		x	
F Pace					x		x			x
XE				x			x		x	
XJ					x		x			x
XF - XF Sportback					x		x			x
X-Type				x			x			x
S-Type					x		x			x
X-Type Wagon				x			x		x	
XK				x			x		x	
JEEP										
Cherokee-Gran Cherokee					x		x			x
Wrangler			x				x		x	
Compass			x				x		x	
Renegade 2015			x				x		x	
Commander					x		x			x
KIA										
Venga		x				x			x	
Soul		x				x			x	
Rio Berlina-SW.			x				x		x	
Carnival-Sorento					x		x			x
Pride SW.			x				x		x	
Joyce-Carens-Sportage			x				x		x	
Niro			x				x		x	

MODELLO AUTO	18355	18356	18357	18358	18359	18291	18294	77470	77472	77474
MISURA	405x165x116	430x165x116	470x165x116	490x178x116	520x191x116	433x166x116	520x191x116	406x165x119	482x178x119	533x178x119
Stonic		x				x			x	
Optima - Optima SW				x			x			x
Ceed		x				x			x	
LANCIA										
Voyager					x		x			x
Delta			x				x		x	
Y	x					x		x		
Phedra- Thema-Thesis					x		x			x
K-K Coupé					x		x			x
K SW.-Thema SW					x		x			x
Dedra-Dedra SW			x				x		x	
Lybra-Lybra SW			x				x		x	
Ypsilon	x					x		x		
Musa		x				x			x	
LAND ROVER										
Evoque			x				x		x	
Defender				x			x		x	
Freelander-Discovery				x			x			x
Discovery					x		x			x
Discovery Sport				x			x			x
Range Rover					x		x			x
Range Rover Sport					x		x			x
Velar				x			x			x
LEXUS										
CT			x				x		x	
IS			x				x		x	
NX				x			x		x	
IS-IS Wg.			x				x		x	
SC-LS-RX					x		x			x
GS					x		x			x
MASERATI										
Quattroporte					x		x			x
Levante					x		x			x
Ghibli				x			x		x	
MAZDA										
2		x				x		x		
CX3			x				x		x	
CX5				x			x		x	
323 F		x					x		x	
Xedos 6				x			x		x	
626-6 -6 SW				x			x		x	
Premacy-MX5		x				x			x	
3			x				x		x	
5				x			x		x	
MX5		x				x			x	
RX8			x				x		x	
MERCEDES										
CLA			x				x		x	



MODELLO AUTO	18355	18356	18357	18358	18359	18291	18294	77470	77472	77474
MISURA	405x165x116	430x165x116	470x165x116	490x178x116	520x191x116	433x166x116	520x191x116	406x165x119	482x178x119	533x178x119
A 2014			x				x		x	
SLK - SLC		x				x			x	
Citan		x				x			x	
GLA			x				x		x	
GLC - GLC Coupe				x			x		x	
GLE - GLE Coupe					x		x			x
GLK				x			x		x	
Classe A-SLK		x				x			x	
Serie 200 (W124)-Serie E (W210)				x			x			x
Classe E-S-Classe E SW					x		x			x
SL-CL-Vito-Classe M-ML					x		x			x
Classe S					x		x			x
Cl. E SW.-Serie E SW.-Serie 200 SW.					x		x			x
Classe C - C SW - C Coupe			x				x		x	
CLK Coupè-CE-SL-CLK Cabrio			x				x		x	
Classe G-Sport Coupè				x			x		x	
Classe B			x				x		x	
Citan			x				x		x	
Classe C Sport Coupè			x				x		x	
CLS					x		x			x
R					x		x			x
MINI										
Coupe	x					x		x		
Cabrio	x					x		x		
Countryman		x				x			x	
Clubman		x				x			x	
Paceman		x				x			x	
Roadster	x					x		x		
Mini British-Mini Cooper	x					x		x		
One	x					x		x		
MINI 5 door		x				x			x	
Cooper	x					x		x		
MITSUBISHI										
ASX			x				x		x	
Colt		x				x			x	
3000GT-Carisma			x				x		x	
Space Star-Pajero Pinin			x				x		x	
Pajero-L 200				x			x		x	
Lancer St. Wagon			x				x		x	

MODELLO AUTO	18355	18356	18357	18358	18359	18291	18294	77470	77472	77474
MISURA	405x165x116	430x165x116	470x165x116	490x178x116	520x191x116	433x166x116	520x191x116	406x165x119	482x178x119	533x178x119
Pajero Sport			X				X		X	
Outlander				X			X			X
Starwagon				X			X		X	
Space Wagon				X			X		X	
NISSAN										
Leaf			X				X		X	
Juke		X				X			X	
Evalia			X				X		X	
Micra	X					X		X		
Almera			X				X		X	
Pulsar			X				X		X	
X-Trail				X			X		X	
MaximaQX- PatrolGR-Pick UP					X		X			X
Terrano II (passo lungo)					X		X			X
Terrano II (passo corto)			X				X		X	
200 SX- Primera			X				X		X	
Primera SW- Serena-Tino			X				X		X	
Micra C+C	X					X		X		
Note		X				X			X	
350Z - 370			X				X		X	
Quashqai			X				X		X	
Pathfinder					X		X			X
Murano					X		X			X
OPEL										
Adam	X					X		X		
Insigna				X			X			X
Insigna Sport Tourer					X		X			X
Ampera			X				X		X	
Cascada			X				X		X	
CrossLand X		X				X			X	
GrandLand X			X				X		X	
Karl	X					X		X		
Mokka X			X				X		X	
Antara				X			X		X	
Agila-Corsa- Tigra	X					X		X		
Astra-Astra SW.-Coupè- Cabrio			X				X		X	
Meriva- Combo Tour			X				X		X	
Omega- Omega SW- Vectra-Vectra GTS-Calibra				X			X		X	
Frontera				X			X		X	
Vectra SW.- Zafira				X			X		X	
Astra GTC		X				X			X	
Astra		X				X			X	



MODELLO AUTO	18355	18356	18357	18358	18359	18291	18294	77470	77472	77474
MISURA	405x165x116	430x165x116	470x165x116	490x178x116	520x191x116	433x166x116	520x191x116	406x165x119	482x178x119	533x178x119
Astra Twin Top			x				x		x	
Signum					x		x			x
Astra Van			x				x		x	
GT	x					x		x		
PEUGEOT										
108	x					x		x		
208	x					x		x		
2008		x				x			x	
308		x				x			x	
308 SW			x				x		x	
3008			x				x		x	
508 - 508SW				x			x		x	
5008				x			x		x	
Bipper Tepee		x				x			x	
Partner Tepee			x				x		x	
RCZ		x				x			x	
104-106-205	x					x		x		
Ranch			x				x		x	
405-406-406 Coupé-605				x			x		x	
607-807					x		x			x
306 SW.			x				x		x	
405 SW.-406 SW.-307-307 SW			x				x		x	
107	x					x		x		
1007	x					x		x		
207	x					x		x		
207 SW		x				x			x	
207 CC	x					x		x		
307 CC			x				x		x	
407				x			x		x	
407 SW				x			x		x	
407 Coupè			x				x		x	
PORSCHE										
Cayenne					x		x			x
Panamera					x		x			x
911			x				x		x	
Macan				x			x		x	
RENAULT										
Zoe	x					x		x		
Captur		x				x			x	
Koleos				x			x		x	
Twingo	x					x		x		
R19-R21-Scenic-Scenic RX4			x				x		x	
Megane Classic-Megane SW			x				x		x	
Megane Cabrio -Coach			x				x		x	
Laguna Grantour-Safrane				x			x		x	

MODELLO AUTO	18355	18356	18357	18358	18359	18291	18294	77470	77472	77474
MISURA	405x165x116	430x165x116	470x165x116	490x178x116	520x191x116	433x166x116	520x191x116	406x165x119	482x178x119	533x178x119
Vel Satis-Espace					X		X			X
Grand Scenic				X			X		X	
Laguna SW.				X			X		X	
Talisman - Talisman Sporter				X			X		X	
Kadjar			X				X		X	
Megane Scenic-Megane SW			X				X		X	
Clio		X				X			X	
Modus	X					X		X		
SAAB										
9-3 Cabrio			X				X		X	
9-5-9-5 SW				X			X		X	
9000				X			X		X	
9-3 Sport Sedan			X				X		X	
9-3 Sporthatch			X				X		X	
SEAT										
Mii	X					X		X		
Marbella-Arosa	X					X		X		
Ibiza		X				X		X		
Leon			X				X		X	
Alhambra					X		X			X
Arona		X				X			X	
Ateca			X				X		X	
Cordoba-Cordoba SW		X				X			X	
Toledo			X				X		X	
Leon		X				X			X	
Altea			X				X		X	
Altea XL				X			X		X	
SKODA										
CityGO	X					X		X		
Rapid Space Back			X				X		X	
Yeti			X				X		X	
Fabia		X				X			X	
Felicia-Felicia SW.-Fabia SW.		X				X			X	
Karoq		X				X			X	
Kodiaq				X			X			X
Superb				X			X		X	
Octavia-Octavia SW				X			X		X	
Roomster			X				X		X	
SMART										
Smart-Cabrio-Roaster	X					X		X		
Smart Coupè-Cross Blade	X					X		X		
ForFour	X					X		X		



MODELLO AUTO	18355	18356	18357	18358	18359	18291	18294	77470	77472	77474
MISURA	405x165x116	430x165x116	470x165x116	490x178x116	520x191x116	433x166x116	520x191x116	406x165x119	482x178x119	533x178x119
SSANGYONG										
Tivoli		x				x			x	
Kornado			x				x		x	
Rexton					x		x			x
Actyon Sport			x				x		x	
SUBARU										
Trezia	x					x		x		
VRX			x				x		x	
XV			x				x		x	
BRZ		x				x			x	
Justy	x					x		x		
Impreza-Legacy			x				x		x	
Levorg				x			x		x	
Forester-Outback				x			x		x	
Impreza SW-Legacy SW.				x			x		x	
B9 Tribeca					x		x			x
SUZUKI										
Splash	x					x		x		
S-Cross		x					x		x	
Alto-Swift	x					x		x		
Wagon R-Ignis	x					x		x		
Jimmy	x					x		x		
Liana		x				x			x	
Celerio		x				x			x	
Ignis	x					x		x		
Vitara		x				x			x	
Grand Vitara			x				x		x	
SX4			x				x		x	
TATA										
Indica	x					x		x		
Pick Up				x			x		x	
TESLA										
Model S				x			x			x
Model X					x		x			x
Model 3			x				x		x	
TOYOTA										
iQ	x					x		x		
C-HR			x				x		x	
Verso			x				x		x	
Prius			x				x		x	
GT86		x				x			x	
Urban Cruiser		x				x			x	
Yaris	x					x		x		
Prius-Corolla Verso-Corolla 3/5 porte			x				x		x	
Yaris Verso-MR2 Roaster		x				x			x	
Carina-Previa				x			x		x	
Land Cruiser-Land Cruiser Wagon-Hilux					x		x			x

MODELLO AUTO	18355	18356	18357	18358	18359	18291	18294	77470	77472	77474
MISURA	405x165x116	430x165x116	470x165x116	490x178x116	520x191x116	433x166x116	520x191x116	406x165x119	482x178x119	533x178x119
Carina SW.				X			X		X	
Celica-Corolla SW-Picnic			X				X		X	
Avensis-SW-Verso-Camry-Rav4			X				X		X	
Aygo	X					X		X		
Nuova Yaris	X					X		X		
Auris - Auris SW			X				X		X	
VOLKSWAGEN										
UP!/Cross UP!	X					X		X		
Maggiolino Maggiolino Cabriolet			X			X			X	
Arteon				X			X		X	
Tiguan			X				X		X	
Touran			X				X		X	
Touareg					X		X			X
Polo-Lupo	X					X		X		
Golf (tutte - all models)		X				X			X	
New Beetle-New Beetle Cabrio		X				X			X	
Turan-Vento-Passat-Variant				X			X		X	
Sharan					X		X			X
Golf SW-Polo SW			X				X		X	
Bora-Bora Variant-Variant SW			X				X		X	
Fox	X					X		X		
Golf Plus			X				X		X	
Jetta			X				X		X	
T-ROC		X				X			X	
Eos			X				X		X	
Phaeton					X		X			X
VOLVO										
XC60				X			X		X	
XC70				X			X		X	
XC90					X		X			X
S40-V40			X				X		X	
S60-V70-C70 Cabrio-S80				X			X		X	
C30			X				X		X	
V50			X				X		X	
S90-V90					X		X			X
XC40			X				X		X	

ESPOSITORE 4 PIANI

EXPOPLASTIC

- ESPOSITORE IN MATERIALE PLASTICO ANTIURTO 4 PIANI
- 4 SHELVES DISPLAY
- EXPOSANT 4 ÉTAGES
- Aussteller 4 Böden
- EXPOSITOR 4 PISOS

DISPONIBILE CON GRAFICHE
AVAILABLE WITH LOGOS
BOTTARI / GOODYEAR

L'ESPOSITORE VIENE FORNITO VUOTO
THE DISPLAY COMES EMPTY



ESEMPIO CON ALLESTIMENTO CHIMICO
EXAMPLE WITH CHEMICALS



TERGICRISTALLI

WIPER BLADES

SUPPORTO VENDITA TERGICRISTALLI



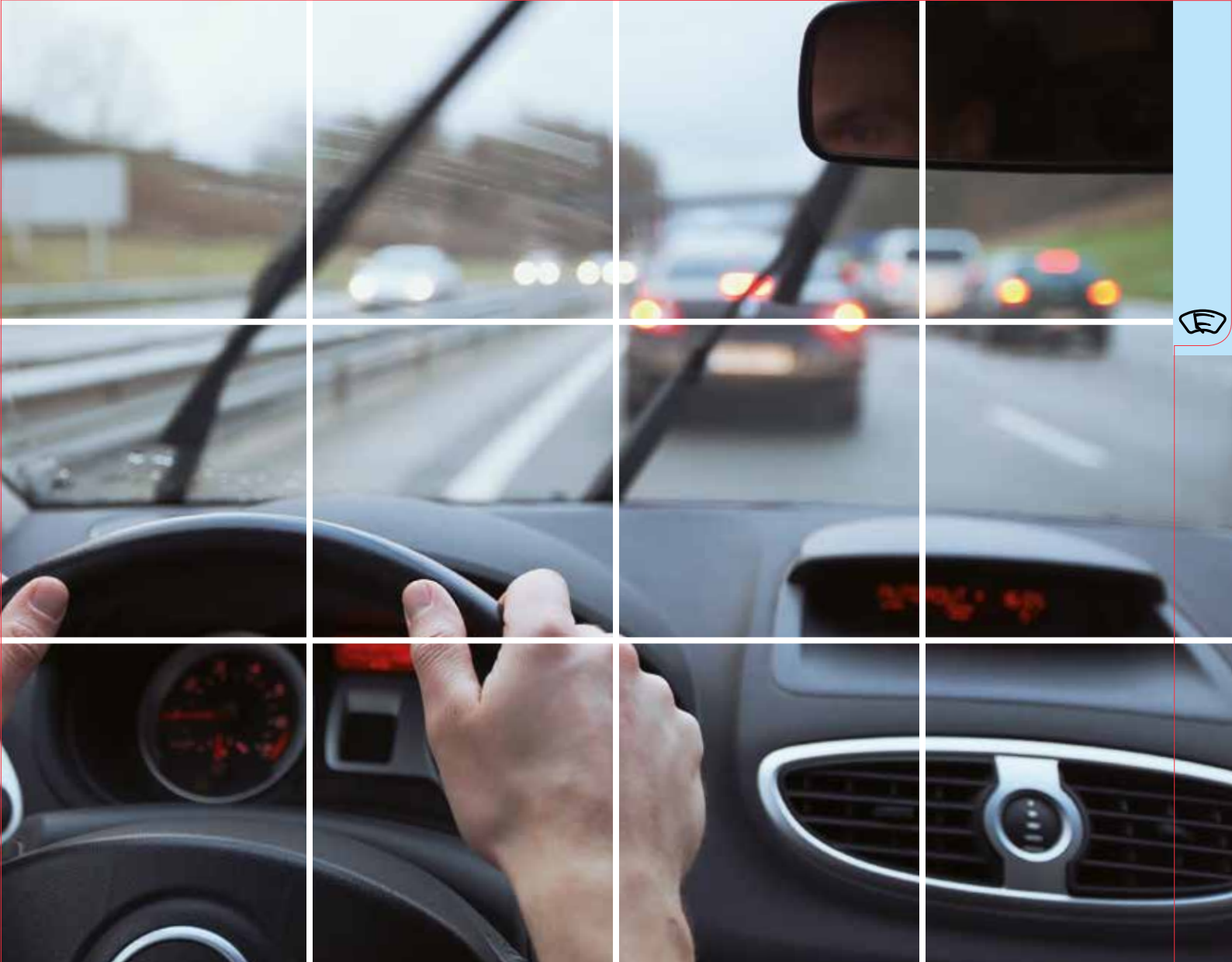

TERGICRISTALLI

WIPER BLADES

SPAZZOLE TERGICRISTALLI GOODYEAR	pag 96
SPAZZOLE TERGICRISTALLI BOTTARI	pag 98
SPAZZOLE TERGICRISTALLI X-TRA - GOMMINI RICAMBIO	pag 101
SPAZZOLE TERGICRISTALLI BOTTARI GRAPHITE	pag 102
SPAZZOLE TERGICRISTALLI X-TRA	pag 103
APPLICATIVO SPAZZOLE	pag 104
ESPOSITORI SPAZZOLE	pag 112



SPAZZOLA TERGI SINGOLA

da **77600** - a **77611**

- SPAZZOLA TERGICRISTALLO FLESSIBILE IN GOMMA
- FLEXIBLE RUBBER WINDSCREEN WIPER
- BROSE ESSUIE-GLACE FLEXIBLE EN CAOUTCHOUC
- Flexibler Gummischiebenwischer
- CEPILLO LIMPIAPARABRISAS FLEXIBLE DE GOMA



MASTER 50 - INNER 10



Spoiler uni-body, aderisce al vetro con una pressione costante ed uniforme, su tutta la superficie.



77600	330 mm	SPAZZOLA TERGI C/GRAFITE 330 mm IN D/BLISTER
77601	350 mm	SPAZZOLA TERGI C/GRAFITE 350 mm IN D/BLISTER
77602	380 mm	SPAZZOLA TERGI C/GRAFITE 380 mm IN D/BLISTER
77603	410 mm	SPAZZOLA TERGI C/GRAFITE 410 mm IN D/BLISTER
77604	450 mm	SPAZZOLA TERGI C/GRAFITE 450 mm IN D/BLISTER
77605	480 mm	SPAZZOLA TERGI C/GRAFITE 480 mm IN D/BLISTER
77606	510 mm	SPAZZOLA TERGI C/GRAFITE 510 mm IN D/BLISTER
77607	530 mm	SPAZZOLA TERGI C/GRAFITE 530 mm IN D/BLISTER
77608	550 mm	SPAZZOLA TERGI C/GRAFITE 550 mm IN D/BLISTER
77609	600 mm	SPAZZOLA TERGI C/GRAFITE 600 mm IN D/BLISTER
77610	650 mm	SPAZZOLA TERGI C/GRAFITE 650 mm IN D/BLISTER
77611	700 mm	SPAZZOLA TERGI C/GRAFITE 700 mm IN D/BLISTER

con gomma grafitata



SPAZZOLA TERGI SINGOLA

da **77641** - a **77651**

- SPAZZOLA TERGI SINGOLA
- SINGLE WIPER BLADES
- BALAI SIMPLE
- Einzelnes Wischblatt
- ESCOBILLA INDIVIDUAL



MASTER 50 - INNER 10



Struttura in metallo leggero e resistente con braccetti multipli di tensione per una migliore e perfetta aderenza al parabrezza.



77641	330 mm	SPAZZOLA TERGI C/GRAFITE 330 mm IN D/BLISTER
77642	350 mm	SPAZZOLA TERGI C/GRAFITE 350 mm IN D/BLISTER
77643	380 mm	SPAZZOLA TERGI C/GRAFITE 380 mm IN D/BLISTER
77644	410 mm	SPAZZOLA TERGI C/GRAFITE 410 mm IN D/BLISTER
77645	450 mm	SPAZZOLA TERGI C/GRAFITE 450 mm IN D/BLISTER
77646	480 mm	SPAZZOLA TERGI C/GRAFITE 480 mm IN D/BLISTER
77647	510 mm	SPAZZOLA TERGI C/GRAFITE 510 mm IN D/BLISTER
77648	530 mm	SPAZZOLA TERGI C/GRAFITE 530 mm IN D/BLISTER
77649	550 mm	SPAZZOLA TERGI C/GRAFITE 550 mm IN D/BLISTER
77650	600 mm	SPAZZOLA TERGI C/GRAFITE 600 mm IN D/BLISTER
77651	650 mm	SPAZZOLA TERGI C/GRAFITE 650 mm IN D/BLISTER

con gomma grafitata



GOMMINI REFILL RICAMBIO

77615 - 77616

- GOMMINO TERGICRISTALLO UNIVERSALE
- UNIVERSAL LONG RUBBER WIPER BLAD
- CAOUTCHOUC DE BALAIS D'ESSUIE GLACES, UNIVERSEL
- Universal-Scheibenwischblätter, für alle Autos
- GOMA LIMPIACRISTALES, UNIVERSAL PARA TODOS LOS COCHES

MASTER 96 - INNER 48

77615	610 mm	GOMMINO REFILL TERGICRISTALLO 610 mm
77616	700 mm	GOMMINO REFILL TERGICRISTALLO 700 mm



ESPOSITORE METALLO CON RUOTE

18535

ASSORTIMENTI VARI



SPAZZOLA TERGI SINGOLA

da 18848 - a 18859

- SPAZZOLA TERGI SINGOLA
- SINGLE WIPER BLADES
- BALAI SIMPLE
- Einzelnes Wischblatt
- ESCOBILLA INDIVIDUAL

visibilità ottimale

ELEMENT 11

MASTER 50 - INNER 10



Non indurisce con il freddo e il gelo



Gomma naturale di alta qualità grafitata resistente al sole



Più sicurezza stradale



Migliora la visibilità con perfetta silenziosità



18848	330 mm	SPAZZOLA TERGI ELEMENT 11 - 330 mm IN SCATOLA/BOX
18849	350 mm	SPAZZOLA TERGI ELEMENT 11 - 350 mm IN SCATOLA/BOX
18850	380 mm	SPAZZOLA TERGI ELEMENT 11 - 380 mm IN SCATOLA/BOX
18851	410 mm	SPAZZOLA TERGI ELEMENT 11 - 410 mm IN SCATOLA/BOX
18852	450 mm	SPAZZOLA TERGI ELEMENT 11 - 450 mm IN SCATOLA/BOX
18853	480 mm	SPAZZOLA TERGI ELEMENT 11 - 480 mm IN SCATOLA/BOX
18854	510 mm	SPAZZOLA TERGI ELEMENT 11 - 510 mm IN SCATOLA/BOX
18855	530 mm	SPAZZOLA TERGI ELEMENT 11 - 530 mm IN SCATOLA/BOX
18856	550 mm	SPAZZOLA TERGI ELEMENT 11 - 550 mm IN SCATOLA/BOX
18857	600 mm	SPAZZOLA TERGI ELEMENT 11 - 600 mm IN SCATOLA/BOX
18858	650 mm	SPAZZOLA TERGI ELEMENT 11 - 650 mm IN SCATOLA/BOX
18859	700 mm	SPAZZOLA TERGI ELEMENT 11 - 700 mm IN SCATOLA/BOX

flessibile e universale
universal soft wiper blade

Adattatori inclusi nella confezione / The package includes adaptors

Tecnologia con struttura interna d'acciaio: si adatta con precisione ad ogni parabrezza, garantendo bilanciamento e stabilità perfetti. È realizzata con una gomma di nuovissima formulazione con trattamento al teflon e grafite, resistente al caldo, al freddo ed ai raggi ultravioletti. È adatta alle condizioni climatiche più estreme, ed al contempo dura fino al 50% in più di una spazzola convenzionale. Inoltre è molto più silenziosa. Il design aerodinamico abbate la rumorosità ed aumenta la stabilità alle alte velocità.

Spring steel design, suitable for any windscreen, ensuring a stable and perfectly balanced action. Made with new teflon and graphite treatment rubber formula, that is heat, cold and ultraviolet rays resistant. It is suitable in the hard er weather conditions, and the life is up to 50% longer than common wipers. It is also noise free. The wind pressure design keep noise low and increase the stability at high speed.



COMPATIBILITÀ
UNIVERSALE

SPAZZOLA TERGI TOP

da 19011N - a 19021N

- SPAZZOLA TERGI SINGOLA
- SINGLE WIPER BLADES
- BALAI SIMPLE
- Einzelnes Wischblatt
- ESCOBILLA INDIVIDUAL

VISION

MASTER 50 - INNER 10

19011N	330 mm	SPAZZOLA TERGI TOP - 330 mm IN SCATOLA/BOX
19012N	350 mm	SPAZZOLA TERGI TOP - 350 mm IN SCATOLA/BOX
19013N	380 mm	SPAZZOLA TERGI TOP - 380 mm IN SCATOLA/BOX
19014N	410 mm	SPAZZOLA TERGI TOP - 410 mm IN SCATOLA/BOX
19015N	450 mm	SPAZZOLA TERGI TOP - 450 mm IN SCATOLA/BOX
19016N	480 mm	SPAZZOLA TERGI TOP - 480 mm IN SCATOLA/BOX
19017N	510 mm	SPAZZOLA TERGI TOP - 510 mm IN SCATOLA/BOX
19018N	530 mm	SPAZZOLA TERGI TOP - 530 mm IN SCATOLA/BOX
19019N	550 mm	SPAZZOLA TERGI TOP - 550 mm IN SCATOLA/BOX
19020N	600 mm	SPAZZOLA TERGI TOP - 600 mm IN SCATOLA/BOX
19021N	650 mm	SPAZZOLA TERGI TOP - 650 mm IN SCATOLA/BOX

con gomma grafitata



universale-perfetta aderenza

universal wiper blade



SPAZZOLA TERGI REAR

da 18890 - a 18895

- SPAZZOLA TERGICRISTALLO POSTERIORE FLESSIBILE IN GOMMA
- FLEXIBLE RUBBER WINDSCREEN WIPER REAR
- BRASSE ESSUIE-GLACE ARRIÈRE FLEXIBLE EN CAOUTCHOUC
- Flexibler Hintere Gummischiebenwischer
- CEPILLO LIMPIAPARABRISAS TRASERO FLEXIBLE DE GOMA

ELEMENT 11
REAR
flessibile e universale
universal soft wiper blade

visibilità ottimale

MASTER 50 - INNER 10



18890	275 mm	SPAZZOLA TERGI ELEMENT 11 REAR - 275 mm IN SCATOLA/BOX
18891	300 mm	SPAZZOLA TERGI ELEMENT 11 REAR - 300 mm IN SCATOLA/BOX
18892	325 mm	SPAZZOLA TERGI ELEMENT 11 REAR - 325 mm IN SCATOLA/BOX
18893	350 mm	SPAZZOLA TERGI ELEMENT 11 REAR - 350 mm IN SCATOLA/BOX
18894	375 mm	SPAZZOLA TERGI ELEMENT 11 REAR - 375 mm IN SCATOLA/BOX
18895	400 mm	SPAZZOLA TERGI ELEMENT 11 REAR - 400 mm IN SCATOLA/BOX

Misura la lunghezza del tuo tergicristallo posteriore e scegli quella più vicina tra le nostre sei proposte

adattatori universali inclusi
in ogni confezione



Nuovo design, con adattatori in dotazione compatibili con qualsiasi autovettura.

Di pura gomma naturale.

Progettato per aumentare le prestazioni di asciugatura ed una maggiore durata.



SPAZZOLA UNIVERSALE

da 11067D - a 11078D

- SPAZZOLA TERGICRISTALLO FLESSIBILE IN GOMMA
- FLEXIBLE RUBBER WINDSCREEN WIPER
- BROSSE ESSUIE-GLACE FLEXIBLE EN CAOUTCHOUC
- Flexibler Gummischiebenwischer
- CEPILLO LIMPIAPARABRISAS FLEXIBLE DE GOMA



MASTER 50 - INNER 10



11067D	330 mm	SPAZZOLA TERGI RAIN TOP mm 330 D/BLISTER
11068D	350 mm	SPAZZOLA TERGI RAIN TOP mm 350 D/BLISTER
11069D	380 mm	SPAZZOLA TERGI RAIN TOP mm 380 D/BLISTER
11070D	410 mm	SPAZZOLA TERGI RAIN TOP mm 410 D/BLISTER
11071D	450 mm	SPAZZOLA TERGI RAIN TOP mm 450 D/BLISTER
11072D	480 mm	SPAZZOLA TERGI RAIN TOP mm 480 D/BLISTER
11073D	510 mm	SPAZZOLA TERGI RAIN TOP mm 510 D/BLISTER
11074D	530 mm	SPAZZOLA TERGI RAIN TOP mm 530 D/BLISTER
11075D	550 mm	SPAZZOLA TERGI RAIN TOP mm 550 D/BLISTER
11076D	600 mm	SPAZZOLA TERGI RAIN TOP mm 600 D/BLISTER
11077D	650 mm	SPAZZOLA TERGI RAIN TOP mm 650 D/BLISTER
11078D	700 mm	SPAZZOLA TERGI RAIN TOP mm 700 D/BLISTER

con gomma grafitata



GOMMINI RICAMBIO 61cm

32135

- GOMMINO TERGICRISTALLO CM 61, UNIVERSALE
- UNIVERSAL CM 61 - LONG RUBBER WIPER BLADE
- CAOUTCHOUC DE BALAIS D'ESSUIE GLACES CM 61, UNIVERSEL
- Universal-Scheibenwischblätter cm 61, für alle Autos
- GOMA LIMPIACRISTALES CM 61, UNIVERSAL PARA TODOS LOS COCHES

1 PEZZO
SFUSO



MASTER 500 - INNER 50

2 GOMMINI IN BLISTER 61cm

18648

- GOMMINO TERGICRISTALLO CM 61, UNIVERSALE
- UNIVERSAL CM 61 - LONG RUBBER WIPER BLADE
- CAOUTCHOUC DE BALAIS D'ESSUIE GLACES CM 61, UNIVERSEL
- Universal-Scheibenwischblätter cm 61, für alle Autos
- GOMA LIMPIACRISTALES CM 61, UNIVERSAL PARA TODOS LOS COCHES



MASTER 96 - INNER 48



SPAZZOLA TERGI SINGOLA

da 18635 - a 18646

- SPAZZOLA TERGI SINGOLA
- SINGLE WIPER BLADES
- BALAI SIMPLE
- Einzelnes Wischblatt
- ESCOBILLA INDIVIDUAL



MASTER 50 - INNER 10



18646
REFILL
610 mm



18646 REFILL

MASTER 96 - INNER 48

Struttura in metallo leggero e resistente con braccetti multipli di tensione per una migliore e perfetta aderenza al parabrezza.

18635	300 mm	SPAZZOLA TERGI C/GRAFITE 300 mm IN D/BLISTER
18636	330 mm	SPAZZOLA TERGI C/GRAFITE 330 mm IN D/BLISTER
18637	350 mm	SPAZZOLA TERGI C/GRAFITE 350 mm IN D/BLISTER
18638	380 mm	SPAZZOLA TERGI C/GRAFITE 380 mm IN D/BLISTER
18639	410 mm	SPAZZOLA TERGI C/GRAFITE 410 mm IN D/BLISTER
18640	450 mm	SPAZZOLA TERGI C/GRAFITE 450 mm IN D/BLISTER
18641	480 mm	SPAZZOLA TERGI C/GRAFITE 480 mm IN D/BLISTER
18642	510 mm	SPAZZOLA TERGI C/GRAFITE 510 mm IN D/BLISTER
18643	530 mm	SPAZZOLA TERGI C/GRAFITE 530 mm IN D/BLISTER
18644	550 mm	SPAZZOLA TERGI C/GRAFITE 550 mm IN D/BLISTER
18645	600 mm	SPAZZOLA TERGI C/GRAFITE 600 mm IN D/BLISTER
		REFIL
18646	610 mm	2 PZ. REFILL C/GRAFITE 610 mm

con gomma grafitata



COPPIA SPAZZOLE TERGI

da 18510 - a 18521

- COPPIA SPAZZOLE TERGICRISTALLO
- PAIR OF WIPER BLADES
- PAIRE DE BALAIS
- Wischblätterpaar
- PAR DE ESCOBILLAS



MASTER 50 - INNER 10



18510	300 mm	2 PZ.SPAZZOLE TERGI C/GRAFITE 300 mm
18511	330 mm	2 PZ.SPAZZOLE TERGI C/GRAFITE 330 mm
18512	350 mm	2 PZ SPAZZOLE TERGI C/GRAFITE 350 mm
18513	380 mm	2 PZ.SPAZZOLE TERGI C/GRAFITE 380 mm
18514	410 mm	2 PZ SPAZZOLE TERGI C/GRAFITE 410 mm
18515	450 mm	2 PZ.SPAZZOLE TERGI C/GRAFITE 450 mm
18516	480 mm	2 PZ.SPAZZOLE TERGI C/GRAFITE 480 mm
18517	510 mm	2 PZ.SPAZZOLE TERGI C/GRAFITE 510 mm
18518	530 mm	2 PZ.SPAZZOLE TERGI C/GRAFITE 530 mm
18519	550 mm	2 PZ.SPAZZOLE TERGI C/GRAFITE 550 mm
18520	600 mm	2 PZ.SPAZZOLE TERGI C/GRAFITE 600 mm
18521	650 mm	2 PZ.SPAZZOLA TERGI C/GRAFITE 650 mm

con gomma grafitata



Struttura in metallo leggero e resistente con braccetti multipli di tensione per una migliore e perfetta aderenza al parabrezza.

COPPIA SPAZZOLE TERGI

da **18527 - a 18532**

- COPPIA SPAZZOLE TERGICRISTALLO
- PAIR OF WIPER BLADES
- PAIRE DE BALAIS
- Wischblätterpaar
- PAR DE ESCOBILLAS



MASTER 50 - INNER 10

18531-18532 REFILL

MASTER 96 - INNER 48



KIT SPAZZOLE

KIT SPAZZOLE		
18527	600+410	2PZ.SPAZZ.TERGI FIAT PUNTO 600+410 mm
18528	530+480	2 PZ.SPAZZOLE TERGI SKODA 530+480 mm
18529	550+450	2 PZ.SPAZZ.TERGI PUNTO 99 550+450 mm
18530	475 mm	1 PZ.SPAZZOLA TERGI C/GRAFITE 475 mm
REFIL		
18531	610 mm	2 PZ. REFILL C/GRAFITE 610 mm IN PTFE
18532	700 mm	2 PZ REFILL C/GRAFITE 700 mm IN PTFE

con gomma grafitata



REFILL
18531 - 610 mm
18532 - 700 mm



SPAZZOLA UNIVERSALE

da **11087 - a 11098**

- SPAZZOLA TERGICRISTALLO FLESSIBILE IN GOMMA
- FLEXIBLE RUBBER WINDSCREEN WIPER
- BROUSSE ESSUIE-GLACE FLEXIBLE EN CAOUTCHOUC
- Flexibler Gummischeibenwischer
- CEPILLO LIMPIAPARABRISAS FLEXIBLE DE GOMA

compatibilità universale

MASTER 50 - INNER 10



11087	330 mm	SPAZZOLA UNIVERSALE 330 mm IN BLIST. card
11088	350 mm	SPAZZOLA UNIVERSALE 350 mm IN BLIST. card
11089	380 mm	SPAZZOLA UNIVERSALE 380 mm IN BLIST. card
11090	410 mm	SPAZZOLA UNIVERSALE 410 mm IN BLIST. card
11091	450 mm	SPAZZOLA UNIVERSALE 450 mm IN BLIST. card
11092	480 mm	SPAZZOLA UNIVERSALE 480 mm IN BLIST. card
11093	510 mm	SPAZZOLA UNIVERSALE 510 mm IN BLIST. card
11094	530 mm	SPAZZOLA UNIVERSALE 530 mm IN BLIST. card
11095	550 mm	SPAZZOLA UNIVERSALE 550 mm IN BLIST. card
11096	600 mm	SPAZZOLA UNIVERSALE 600 mm IN BLIST. card
11097	650 mm	SPAZZOLA UNIVERSALE 650 mm IN BLIST. card
11098	700 mm	SPAZZOLA UNIVERSALE 700 mm IN BLIST. card

con gomma grafitata



MARCA E MODELLO	ANNO	MISURA	MISURA	SPAZZOLA FLAT IN GOMMA CON ADATTATORI	SPAZZOLA TRADIZIONALE CON TELAIO IN METALLO PER ATTACCO A U/BAIONETTA
ABARTH					
500/C	2008>	600	350	x	
PUNTO	2010>	650	380	x	
ALFA ROMEO					
147	11.00>05.05	550	410	x	x
147	10.05>2010	550	410	x	
155	02.92>04.96	530	480	x	x
164	09.92>10.98	530	530	x	x
166	10.98>10.07	530	480	x	x
145/146	04.97>12.00	550	480	x	x
145/146	04.94>04.97	550	510	x	x
155/166	02.92>10.07	530	480	x	x
156/Cross W. Q4/SW	10.97>12.05	550	510	x	x
159 e Sport Wagon	06.05>2011	550	450	x	
33 / 33 SW	83>94	450	450	x	x
75	10.86>12.93	450	450	x	x
Brera/Spider	01.06>2011	550	450	x	
Giulietta	05.10>	550	450	x	
GT	10.03>2010	550	410	x	
Mito	08.08>	650	380	x	
Spider (Duetto)	01.90>12.94	450	450	x	x
AUDI					
90	03.92>06.95	530	530	x	x
100 /Avant	12.90>07.94	550	510	x	x
80/Avant	09.91>07.95	530	510	x	x
A1/A1 Sportback	05.10>	600	380	x	
A2	09.99>06.01	700		x	x
A2	07.01>08.05	700		x	
A3 cabrio	04.08>	600	450	x	
A3/S3	09.96>06.03	530	480	x	x
A3/Sportback	12.04>2012	600	480	x	x
A3/Sportback	2012>	600	480	x	
A4/A4 Avant	11.94>09.01	530	530	x	x
A4/avant/cabrio	11.03>06.08	550	550	x	
A4/avant/Allroad	11.07>	600	510	x	
A5/Sportback/cabrio	06.07>	600	510	x	
A6/Avant	06.94>05.01	550	530	x	x
A6/Avant/Allroad	06.01>05.12	550	550	x	
A6 Avant/Allroad	01.12>	650	530	x	
A6/A6 Avant	06.94>12.97	550	530	x	x
A6/Avant /Allroad	2011>	650	530	x	
A7 Sportback	07.10>	600	510	x	
A8 / S8	94>02	550	530	x	x
A8 / S8	11.09>	650	510	x	
Cabriolet	06.91>08.00	550	530	x	x
Q3	06.11>	600	510	x	
Q5	06.2008>	600	510	x	
Q7	03.06>	650	600	x	
S1	01.11>	600	380	x	
S3	08.98>06.03	530	480	x	x
S3/Sportback	11.06>	600	480	x	
S4/Avant	08.98>09.01	530	530	x	x
S4/Avant/Cabrio	03.09>	550	550	x	
S5 tutte	11.07>	600	510	x	
S6	06.94>10.97	550	530	x	x
S6/Avant	04.12>	650	530	x	
TT Coupé/ TT Roadster	07.98>04.03	550	530	x	x
TT Coupé/ TT Roadster	07.06>	550	530	x	
TT Coupé/ TT Roadster	10.03>06.06	530	530	x	
BMW					
Serie 1 (E81/E82/E88/E87)	09.04> 09.11	510	510	x	
Serie 1 (F20/F21)	09.11>	550	450	x	
Serie 3 (E36) berlina/ cabrio/touring	09.90>12.98	530	510	x	x
Serie 3 (E 46) berlina/ cabrio/touring	04.98>09.05	600	480	x	x
Serie 3 berlina (E90) e Touring (E91)	03.05>2011	600	480	x	

MARCA E MODELLO	ANNO	MISURA	MISURA	SPAZZOLA FLAT IN GOMMA CON ADATTATORI	SPAZZOLA TRADIZIONALE CON TELAIO IN METALLO PER ATTACCO A U/BAIONETTA
Serie 3 Compact (E 46)	06.01>12.04	600	480	x	x
Serie 3 Compact (E 36)	03.94>09.00	510	510	x	x
Serie 3 berlina (F30) e touring (F31)	2012>	600	480	x	
Serie 3 Coupè (E92)	09.09>	600	410	x	
Serie 5 (E34) berlina e touring	01.88>12.95	600	600	x	x
Serie 5 berlina (E60) e touring (E61)	07.03>02.10	600	550	x	
Serie 5 GT (F07)	10.09>	650	450	x	
Serie 5 Touring (F11)	09.10>	650	450	x	
Serie 5(F10)	03.10>	650	450	x	
Serie 6/Cabrio (E63/E64)	04.04>2010	600	550	x	
Serie 6 (F12)	03.11>	650	410	x	
Serie 7 (E38-E65-E66)	06.94>10.08	600	600	x	x
Serie 7 (F01)	11.08>	650	450	x	
Serie M (E 60/E63)	11.04>2008	600	550	x	
Serie M /cabrio/coupè (E 36)	09.92>12.99	530	510	x	x
Serie M Cabrio (E 64)	11.06>02.08	600	550	x	
Serie M Cabrio/ Coupè (E 46)	09.00>08.06	550	510	x	x
Serie M Touring (E 34)	04.92>12.95	600	600	x	x
X1 (E84)	11.09>	600	480	x	
X3 (E83)	01.04>2010	550	510	x	x
X3 (F25)	09.10>	650	510	x	
X5 (E53)	03.99>10.06	600	550	x	x
X5 (E70)	11.06>2013	600	510	x	
X6 (E71)	03.08>	600	510	x	
Z3 (E36/37) / Z3 coupè (E36/38)	03.95>09.02	510	510	x	x
Z4 (E85) / Z4 coupè (E86)	10.02>07.07	530	510	x	x
Z4 (E89)	04.09>	530	530	x	x
CADILLAC					
SRX	09.03>08.09	550	530	x	x
Escalade	09.06>	550	530	x	x
CHEVROLET					
Aveo/Kalos (Daewoo)	04.08>2011	550	410	x	x
Aveo	06.2011>	650	380	x	
Captiva	10.06>	600	410	x	x
Cruze/SW	2010>	600	450	x	x
Epica / Evanda	06.06>2010	550	510	x	x
Kalos	02.05>2008	550	410	x	x
Lacetti (Daewoo)	02.05>2010	550	480	x	x
Lanos	01.04>2006	480	480	x	x
Matiz	02.05>2009	550	350	x	x
Nubira/SW	02.05>2010	550	480	x	x
Orlando	10>	600	480	x	x
Spark	12.09>	550	380	x	x
Tacuma	09.00>02.05	600	450	x	x
Trax	2013>	650	350	x	x
Trailblazer	01>2008	550	550	x	x
Volt	10.11>	650	650	x	
CHRYSLER					
300/300C - 300C Touring	10.04>	550	530	x	x
300L	01.05>	550	550	x	x
300M	06.98>12.04	600	480	x	x
Crossfire Coupè/ Roadster	03.02>2008	550	510	x	x
Grand Voyager	09.07>	650	510	x	x
PT Cruiser/Cabrio	06.00>2008	530	510	x	x
Sebring Coupè	95>00	600	550	x	x
Sebring/Cabrio	10.00>12.06	550	530	x	x
Sebring/Cabrio	01.07>	600	550	x	x
Stratus/Cabrio	08.95>04.01	550	530	x	x
Voyager	01.96>2008	700	700	x	
Voyager	2009>	650	510	x	x

MARCA E MODELLO	ANNO	MISURA	MISURA	SPAZZOLA FLAT IN GOMMA CON ADATTATORI	SPAZZOLA TRADIZIONALE CON TELAIO IN METALLO PER ATTACCO A U/BAIONETTA
CITROEN					
AX	06.90>12.98	550		x	x
Berlingo	05.08>	650	410	x	
Berlingo	07.96>04.08	550	530	x	x
C1	06.05>2014	650		x	x
C2	09.03>2009	600	450	x	x
C3	01.02>2009	600	410	x	x
C3	09.09>	650	410	x	
C3 Picasso	02.09>03.10	600	410	x	
C3 Picasso	04.10>	600	410	x	
C3 Pluriel	05.03>2009	550	450	x	x
C3 XTR	02>2009	600	450	x	x
C4 / C4 Coupé	11.04>2010	700	600	x	x
C4 Aircross	2012>	600	530	x	x
C4	09.10>	700	650	x	
C4 Picasso/Grand Picasso	04.08>	700	700	x	
C5 - C5 Tourer	04.08>	700	550	x	
C5/Break	06.01>11.03	650	450	x	x
C5/Break	12.03>03.08	650	480	x	
C6	11.05>2012	700	700	x	
C8	08.05>	650	650	x	x
C-Crosser	09.07>	600	530	x	x
CX	>92	600			
C Zero	10.10>	700		x	
DS3	11.09>	600	510	x	
DS4	03.11>	700	650	x	
DS5	09.11>	700	650	x	
Jumper	02.94>05.06	550	530	x	x
Jumper	06.06>	650	530	x	
Jumpy	10.95>2007	650	510	x	x
Jumpy	02.07>	700	510	x	x
Nemo	02.08>	650	480	x	
Saxo	02.96>09.03	510	450	x	x
Xantia/Break	01.93>11.01	600	510	x	x
XM	91>98	550		x	x
Xsara Picasso	01.00>2013	650	650	x	x
Xsara/coupé/break	07.97>2010	550	510	x	x
ZX/Break	03.91>02.98	550		x	x
DACIA					
Duster/Logan I/ MCV/Sandero I	07.04>	510	510	x	x
Dokker/Lodgy	08.12>	550	410	x	x
Sandero II/Logan II	08.12>	550	510	x	x
DAEWOO					
Kalos - 3/5p.	09.02>01.05	550	410	x	x
Leganza/Evanda	03.97>01.05	550	510	x	x
Matiz	04.98>01.05	530	380	x	x
Nubira s.w.	10.99>06.03	550	480	x	x
Nubira/SW	09.97>09.99	510	510	x	x
Lanos	96>03	480	480	x	x
Tacuma	04.00>01.05	600	480	x	x
DAIHATSU					
Charade - 3/5p.	01.93>09.00	480	410	x	x
Copen	03>2010	450	410	x	x
Cuore	10.98>03.03	450	380	x	x
Cuore	03.03>	530		x	x
Materia	09.06>	510	480	x	x
Feroza	10.88>10.99	410	410	x	x
Rocky	84>02	410	410	x	x
Sirion	04.98>07.04	480	410	x	x
Sirion	10.04>	510	410	x	x
Terios	03.97>12.05	510	380	x	x
Terios	01.06>	530	450	x	x
Trevis	08.06>	510	410	x	x
DODGE					
Avenger	01.07>2011	600	550	x	x
Caliber	01.06>2011	600	410	x	x

MARCA E MODELLO	ANNO	MISURA	MISURA	SPAZZOLA FLAT IN GOMMA CON ADATTATORI	SPAZZOLA TRADIZIONALE CON TELAIO IN METALLO PER ATTACCO A U/BAIONETTA
Journey	03.08>2011	600	450	x	x
Nitro	01.07>2011	480	480	x	x
FERRARI					
348	02.90>04.94	510	510	x	x
360 Modena	03.99>2006	600	530	x	x
F355	95>1999	530	510	x	x
FIAT					
126	87>00	330	330	x	x
500	07.07>	600	350	x	
500L	09.12>	650	380	x	
Barchetta	01.95>02.05	480	480	x	x
Brava/Bravo	10.95>09.01	550	510	x	x
Bravo	03.07>	600	450	x	
Cinquecento	07.91>07.98	480	480	x	x
Coupé	02.94>09.00	530	480	x	x
Croma	06.05>2011	600	410	x	
Croma	05.91>12.96	510	480	x	x
Doblò	10.09>	600	410	x	
Doblò	07.00>2009	550	450	x	x
Ducato	03.94>08.06	550	530	x	x
Ducato	06.06>	650	550	x	
Fiorino	09.93>12.01	450		x	
Fiorino	12.07>	650	450	x	
Freemont	2011>	600	480	x	x
Grande Punto	10.05>	650	350	x	
Idea	04.08>2012	550	380	x	
Idea	01.06>03.08	550	380	x	x
Idea	01.04>12.05	550	410	x	x
Marea/Marengo/ weekend	10.96>2002	550	480	x	x
Marengo	02.90>12.96	510	510	x	x
Marengo	01.97>09.02	550	480	x	x
Multipla	01.06>2011	600	550	x	x
Multipla	01.99>12.05	600	530	x	x
Palio/Weekend	09.97>2003	550	450	x	x
Panda / 4x4	80>03	410		x	x
Panda Classic/4x4	10.03>2011	550	410	x	x
Panda/Panda 4x4/ Panda Trekking	2012>	600	350	x	x
Punto 3/5p / Punto Van	07.99>2010	530	450	x	x
Punto e Van	08.93>08.99	550	410	x	x
Punto Evo	10.09>	650	380	x	
Qubo	09.08>	650	450	x	
Scudo	09.95>04.98	700	510	x	x
Scudo	05.98>01.07	650	510	x	x
Scudo	01.07>	700	510	x	
Sedici	05.06>2013	650	350	x	x
Seicento	03.98>2010	480	480	x	x
Siena	05.98>12.01	550	450	x	x
Stilo/Multi W	10.01>06.05	530	480	x	x
Stilo/Multi W	07.05>12.07	550	480	x	
Tempra/SW	02.90>12.96	510	510	x	x
Tipo	07.87>03.93	480	480	x	x
Ulysse	09.94>09.02	650	510	x	x
Ulysse	11.05>12.10	650	650	x	x
Uno	83>95	450		x	x
FORD					
B-Max	2012>	700	600	x	
C-Max	03.07>07.10	650	480	x	
C-Max/Grand C-Max	08.10>	700	600	x	
Cougar	08.98>12.00	550	510	x	x
Escort/SW	07.90>07.00	510	510	x	x
Escort/S.W.	06.85>10.90	450	450	x	x
Fiesta	11.01>07.08	550	410	x	x
Fiesta	03.89>12.02	480	480	x	x
Fiesta	07.08>	650	380	x	x
Focus	07.04>2011	650	410	x	x
Focus e sw	07.04>10.08>	650	410	x	x



MARCA E MODELLO	ANNO	MISURA	MISURA	SPAZZOLA FLAT IN GOMMA CON ADATTATORI	SPAZZOLA TRADIZIONALE CON TELAIO IN METALLO PER ATTACCO A U/BAIONETTA
Focus s.w.	11.08>2011	650	410	x	x
Focus/SW	08.98>05.05	550	480	x	x
Focus/Wagon	01.2011>	700	700	x	
Fusion	10.02>2010	550	410	x	x
Galaxy	04.01>08.06	700	700	x	
Galaxy	03.06>	700	650	x	
Ka	09.96>09.08	480	410	x	x
Ka	09.08>	600	350	x	
Kuga	02.08>2012	600	410	x	
Kuga	11.2012>	700	700	x	
Mondeo I/II 4/5p	01.93>09.00	530	510	x	x
Mondeo III/SW	10.00>03.07	550	510	x	x
Mondeo IV/SW	02.07>	650	480	x	x
Puma	06.97>12.01	480	480	x	x
Ranger	94>09	450	450	x	x
Ranger	09.11>	600	410	x	x
Scorpio/SW	02.92>12.98	510	510	x	x
S-Max	03.06>	750	650	x	
Tourneo Connect/Transit Connect	05.02>	550	510	x	x
Transit	08.91>08.00	550	530	x	x
Transit Tourneo/Transit	01.00>	700	600	x	
Transit Tourneo	08.91>08.00	550	530	x	x
GREAT WALL					
Hover	02.07>	510	480	x	x
Steed	12.06>	550	480	x	x
Voleex	2013>	600	380	x	x
HONDA					
Accord/Accord Tourer	07.08>	600	550	x	x
Accord 3/5p.	10.98>02.03	550	480	x	x
Accord 4p.	01.90>02.03	550	480	x	x
Accord Aerodeck/Coupè	91>98	550	510	x	x
Accord e Acc. Tourer	02.03>08.08	650	410	x	x
Civic Aerodeck	03.98>02.01	510	450	x	x
Civic	10.95>02.01	510	450	x	x
Civic	02.01>12.05	600	380	x	x
Civic	01.06>08.11	700	550	x	
Civic	09.11>	650	450	x	x
Civic (TUTTE)	91>2000	510	450	x	x
Civic 4p.	09.05>2012	650	550	x	x
Civic 4p/Coupè	02.01>01.06	530	480	x	x
Civic Coupè	09.92>08.00	510	450	x	x
Civic CRX	03.92>12.98	510	450	x	x
Civic Fastback	09.94>02.01	510	450	x	x
Civic Hybrid	01.06>12.07	700	550	x	
Civic Hybrid	01.08>	650	550	x	x
Civic/4p/Aerodeck	10.95>02.01	510	450	x	x
CR-V	10.95>02.02	480	480	x	x
CR-V	03.02>09.06	530	510	x	x
CR-V	01.07>2012	650	410	x	x
CR-V	2013>	650	410	x	x
CR-Z	03.10>	650	510	x	x
FR-V	01.05>2010	650	450	x	x
HR-V	12.98>12.05	510	450	x	x
Insight	08.00>12.06	510	450	x	x
Insight	04.09>	650	410	x	x
Jazz	03.02>12.08	530	380	x	x
Jazz	11.08>	650	350	x	x
Legend	01.96>12.04	510	480	x	x
Logo	10.96>06.01	510	450	x	x
Prelude	02.92>09.96	530	480	x	x
Shuttle	01.95>05.01	550	550	x	x
Stream	05.01>2009	600	350	x	x
S2000	04.99>06.09	510	410	x	x

MARCA E MODELLO	ANNO	MISURA	MISURA	SPAZZOLA FLAT IN GOMMA CON ADATTATORI	SPAZZOLA TRADIZIONALE CON TELAIO IN METALLO PER ATTACCO A U/BAIONETTA
HUMMER					
H2 e H3	04>10	410	410	x	x
HYUNDAI					
Accent 3/4/5p.	04.06>01.11	550	410	x	x
Accent 3/5p.	08.94>03.06	510	450	x	x
Accent Blue	01.11>	650	410	x	x
Atos/Atos Prime	09.97>03.08	510	410	x	x
Coupè	05.96>2008	550	450	x	x
Elantra	10.90>2011	510	450	x	x
Galloper	98>2005	450	450	x	x
Genesis coupè	10.08>	600	510	x	x
Getz	09.02>2009	550	350	x	x
H-1	10.97>05.07	650	510	x	x
H-1	03.08>	600	510	x	x
H100	05.05>	450	450	x	x
i10	03.08>	550	410	x	x
i20	01.09>	600	410	x	x
ix20	2010>	650	350	x	x
i30 - i30 CW	09.07>03.10	600	450	x	x
i30 - i30 CW	04.10>	600	450	x	x
ix35	03.10>	600	410	x	x
i40 / wagon	2012>	650	410	x	x
Lantra/sw	10.90>09.00	510	450	x	x
Matrix	08.01>2009	550	410	x	x
Pony	07.94>07.99	510	450	x	x
Santa Fé	09.99>12.05	550	510	x	x
Santa Fé	11.05>2012	600	450	x	x
Santa Fé	06.12>	650	330	x	x
Sonata	03.98>03.01	510	510	x	x
Sonata	04.01>11.04	550	510	x	x
Sonata	12.04>2008	600	510	x	x
Terracan	07.01>2006	550	510	x	x
Trajet	01.00>06.07	650	550	x	x
Tucson	08.04>2010	600	410	x	x
Veloster	06.11>	650	450	x	x
INFINITI					
FX	10.08>	550	510	x	x
EX	04.08>	600	450	x	x
INNOCENTI					
Elba	08.91>03.96	450		x	x
Mille	07.94>11.97	450	450	x	x
ISUZU					
D-Max	05.02>	550	480	x	x
Trooper	08.92>09.04	510	510	x	x
JAGUAR					
S-Type	10.98>04.02	550	550	x	x
S-Type	2002>2008	600	450	x	x
XF/SportBrake	03.08>	600	480	x	
XJ	08.10>	600	480	x	
XJ8 / XJR8	09.97>01.03	530		x	x
XJS	>96	380	380	x	x
XK 8	01.99>2008	530	530	x	x
XKR 8	01.99>2008	530	530	x	x
X-Type / X-Type s.w.	03.01>2010	550	480	x	x
JEEP					
Cherokee	03.01>12.07	480	480	x	x
Compass	10.06>	550	510	x	x
Grand Cherokee	09.91>04.99	510	510	x	x
Grand Cherokee	04.99>2010	530	530	x	x
Grand Cherokee	2010>	550	530	x	x
Patriot	10.06>	530	530	x	x
Wrangler	01.97>2007	380	380	x	x
Wrangler	01.07>	380	380	x	x
KIA					
Carens	04.99>12.06	600	450	x	x
Carens	04.06>2010	650	450	x	x
Carnival	06.98>2006	600	600	x	x

MARCA E MODELLO	ANNO	MISURA	MISURA	SPAZZOLA FLAT IN GOMMA CON ADATTATORI	SPAZZOLA TRADIZIONALE CON TELAIO IN METALLO PER ATTACCO A U/BAIONETTA
Carnival	01.06>	650	450	x	x
Cee'd/SW/Pro Cee'd	11.06>06.09	600	450	x	x
Cee'd/SW	2009>	600	450	x	x
Cerato	03.04>2008	600	410	x	x
Magentis	09.00>12.05	550	510	x	x
Picanto	05.04>	550	410	x	x
Pride	05.90>02.00	450	450	x	x
Rio	03.05>2011	550	410	x	x
Rio s.w.	09.02>02.05	530	450	x	x
Rio	2011>	650	410	x	x
Shuma	01.98>08.04	530	480	x	x
Sorento	07.02>2008	600	450	x	x
Sorento / Soul	09.08>	600	510	x	x
Sportage	05.93>08.04	510	510	x	x
Sportage	08.04>2010	600	410	x	x
Sportage	2010>	600	450	x	x
Venga	12.09>	650	350	x	x
LADA					
Niva	09.02>	510	510	x	x
LANCIA					
Dedra SW/Delta	01.93>10.99	530	480	x	x
Delta	07.08>	600	450	x	x
Flavia	06.12>	600	550	x	x
Kappa / SW	11.94>12.00	600	510	x	x
Lybra/SW	10.99>11.06	550	530	x	x
Musa	01.06>09.07	550	380	x	x
Musa	10.07>2012	550	380	x	x
Musa	10.04>12.05	550	410	x	x
Phedra	10.05>2011	650	650	x	x
Thema / SW	05.92>11.94	510	510	x	x
Thema	2012>	600	530	x	x
Thesis	04.02>2011	650	510	x	x
Thesis / Zeta	09.94>06.02>	650	510	x	x
Voyager	2011>	650	510	x	x
Y	01.96>06.03	550	410	x	x
Y10	85 > 96	450	450	x	x
Ypsilon	06.03>2011	600	410	x	x
Ypsilon	2011>	600	380	x	x
Zeta	09.94>06.02	650	510	x	x
LAND ROVER					
Defender 90/110	85>	330	330	x	x
Discovery I/II	09.89 > 12.04	450	450	x	x
Discovery III/IV	10.04>	550	530	x	x
Evoque	2011>	600	530	x	x
Freelander I	09.97>03.07	550	530	x	x
Freelander II	10.06>	600	480	x	x
Range Rover I	11.88>04.96	450	450	x	x
Range Rover II	09.94>09.02	550	550	x	x
Range Rover	09.11>	600	530	x	x
Range Rover Sport	03.05>2013	550	530	x	x
LEXUS					
CT200	2010>	650	450	x	x
ES	03.06>	600	480	x	x
GS	08.97>2012	600	510	x	x
IS	01.99>07.05	550	480	x	x
IS/C	08.05>	550	510	x	x
LS	08.00>2010	600	410	x	x
LX	11.07>	600	550	x	x
LX 470	98>2007	510	510	x	x
RX	02.03>	650	550	x	x
RX	01.98>02.03	600	530	x	x
MAZDA					
2	06.07>	600	330	x	x
2	02.03>06.07	600	410	x	x
3	07.03>12.08	530	480	x	x
3	12.08>	600	480	x	x
5	02.05>	650	410	x	x

MARCA E MODELLO	ANNO	MISURA	MISURA	SPAZZOLA FLAT IN GOMMA CON ADATTATORI	SPAZZOLA TRADIZIONALE CON TELAIO IN METALLO PER ATTACCO A U/BAIONETTA
6/Wagon	08.07>05.2013	600	410	x	x
6/Wagon	2013>	600	450	x	x
323	05.98>09.03	530	450	x	x
6/berlina/W	02.02>08.07	550	480	x	x
626/SW	05.97>09.99	530	450	x	x
626 Fastback	08.99>04.02	530	450	x	x
B Serie/BT-50	03.96>03.06	450	450	x	x
CX-5	04.2012>	600	450	x	x
CX-7	12.06>	650	410	x	x
CX-9	09.06>	650	410	x	x
MPV	06.99>08.04	600	600	x	x
MX-3	05.91>01.99	530	450	x	x
MX-5	89>	450	450	x	x
Premacy	03.99>05.05	600	410	x	x
RX-7 Coupé	08.93>02.96	510	510	x	x
RX-8	04.03>2011	510	450	x	x
Tribute	02.01>2010	480	480	x	x
MERCEDES BENZ					
CL	03.00>	650	650	x	x
CLA	03.13>	650	600	x	x
A	10.97>08.04	650	600	x	x
A	09.04>2012	650	550	x	x
A	06.12>	600	480	x	x
B	09.04>2011	650	550	x	x
B	2012>	650	480	x	x
C (W202)	03.93>04.00	600		x	x
C (W203)	05.00>06.03	600	530	x	x
C (W204)	03.07>	600	600	x	x
C S.W. (S202)	05.96>02.01	600		x	x
C S.W. (S203)	01.01>06.03	600	530	x	x
C S.W. (S204)	09.07>	600	600	x	x
C Sportcoupé (W203)	01.01>06.03	600	530	x	x
C Coupe	03.11>	600	600	x	x
E (W124)	02.92>07.95	600		x	x
E (W210)	06.95>01.03	650		x	x
E (W211)	03.02>2008	650	650	x	x
E (W212)	08.08>	600	600	x	x
E cabrio/coupé	03.93>06.98	600		x	x
E cabrio/coupé	02.09>	600	600	x	x
E S.W. (S124)	07.93>05.96	600		x	x
E S.W. (S210)	05.96>01.03	650		x	x
E S.W. (S211)	02.03>08.09	650	650	x	x
E S.W. (S212)	08.09>	600	600	x	x
G (tutte)	79>	410	410	x	x
GL (164)	02.06>	700	530	x	x
GLA	02.14>	600	480	x	x
GLK (204)	06.08>	550	450	x	x
ML (163)	03.98>06.05	550	530	x	x
ML/GL (164)	07.05>2011	700	530	x	x
ML(166)	09.11>	650	550	x	x
R (251)	02.06>	700	530	x	x
S	03.00>	650	650	x	x
Citan (fix. a gancio e spina)	07.12>	550	530	x	x
CLK (C208)	01.97>06.02	600		x	x
CLS (C219)	06.04>2010	650	650	x	x
CLS (C218)/Shooting-Brake	10.10>	600	600	x	x
SL (129)	07.93>08.01	600		x	x
SL (230)	10.01>	650	650	x	x
SLK	09.96>03.04	550	530	x	x
SLK	04.04>	550	550	x	x
SLR	04.04>	650	650	x	x
Sprinter	02.95>05.06	600	530	x	x
Sprinter	04.06>	650	600	x	x
Vaneo	02.04>08.05	650	550	x	x
Vaneo	02.02>01.04	650	600	x	x

MARCA E MODELLO	ANNO	MISURA	MISURA	SPAZZOLA FLAT IN GOMMA CON ADATTATORI	SPAZZOLA TRADIZIONALE CON TELAIO IN METALLO PER ATTACCO A U/BAIONETTA
Vario	01.96>09	600		x	x
Viano	09.05>	700	650	x	
Vito	10.03>	700	650	x	
MINI					
Clubman	11.07>	450	450	x	x
Mini/Cabrio	06.01 >2014	450	450	x	x
Contryman	2010>	480	510	x	
Coupè/Roadster	2011>	510	510	x	
Paceman	2013>	480	510	x	
MITSUBISHI					
ASX	04.10>	600	530	x	x
Carisma	05.96>12.03	530	510	x	x
Colt	11.95>06.03	530	480	x	x
Colt	04.04>2010	650	300	x	x
Eclipse	01.90>03.94	510	510	x	x
Galant / SW	10.96>09.02	530	450	x	x
Galant 3/5p.	11.92>10.96	530	480	x	x
Galopper	05.98>12.01	450	450	x	x
Grandis	01.04>2010	700	550	x	
L200	12.05>10.09	530	480	x	x
L200	11.09>	550	450	x	x
L 410	12.94>03.01	650	650	x	x
Lancer	03.07>	600	410	x	x
Lancer	11.95>05.01	530	480	x	x
Lancer/SW	12.00>04.10	600	450	x	x
Outlander	02.07>2012	600	550	x	x
Outlander	04.12>	650	450	x	x
Pajero	06.00>10.06	510	510	x	x
Pajero	12.90>06.00	480	480	x	x
Pajero	10.06>	550	510	x	x
Pajero Pinin	06.98>2008	480	480	x	x
Pajero Sport	07.96>02.09	510	510	x	x
Pajero Sport	07.08>	550	450	x	x
Space Wagon	06.92>11.00	550	510	x	x
Spacestar	06.98>	530	450	x	x
NISSAN					
350 Z Cabrio/Coupé	07.03>2010	510	450	x	x
Almera	01.00>11.06	550	410	x	x
Almera	07.95>04.00	530	480	x	x
Almera Tino	05.00>12.05	650	450	x	x
Cabstar	10.98>08.06	450	450	x	x
Cabstar	09.06>	510	510	x	x
Cube	08.09>	510	510	x	x
Evalia	01.11>	550	410	x	x
Kubistar (con port.post.)	07.03>	510	510	x	x
Maxima QX	10.94>01.00	530	530	x	x
Maxima QX	01.00>01.06	650	450	x	x
Micra	08.92>10.02	510	450	x	x
Micra / Micra CC	11.02>05.05	530	450	x	x
Micra	06.05>2010	530	450	x	x
Micra	2010>	530	330	x	x
Murano	09.04>12.08	650	450	x	x
Murano	06.08>	650	410	x	x
Navara	06.00>2005	480	480	x	x
Navara/ Pathfinder	05.05>	600	480	x	x
Note	01.06>2013	600	350	x	x
NV200	08.09>	550	410	x	x
Pathfinder	10.97>12.04	550	510	x	x
Pathfinder/Navara	01.05>	600	480	x	x
Patrol	89>98	480	480	x	x
Patrol GR	08.97>	510	510	x	x
Patrol GR	08.87>11.97	480	480	x	x
Pick-up	08.87>05.98	480	480	x	x
Pixo	03.09>	550	350	x	x
Primastar (c/porta post.)	07.02>	600	530	x	x
Primeria 4/5p	06.96>12.01	530	510	x	x
Primeria 4/5p/W	06.90>06.96	530	480	x	x

MARCA E MODELLO	ANNO	MISURA	MISURA	SPAZZOLA FLAT IN GOMMA CON ADATTATORI	SPAZZOLA TRADIZIONALE CON TELAIO IN METALLO PER ATTACCO A U/BAIONETTA
Primeria 4/5p/W	12.01>2010	650	450	x	x
Primeria Wagon	01.98>12.01	530	510	x	x
Primeria Wagon	12.01>2010	650	450	x	x
Qashqai - Qashqai+2	12.06>2013	600	380	x	
Juke	2010>	550	350	x	x
Serena	12.01>05.05	550	410	x	x
Vanette	07.92>11.01	600	600	x	x
Sunny 3/4/5p/W	10.90>05.95	530	480	x	x
Terrano	86>96	450	450	x	x
Terrano II	05.96>12.06	530	510	x	x
Vanette Cargo	07.92>11.01	600	600	x	x
X-Trail	06.01>	600	410	x	x
OPEL					
Adam	13>	650	410	x	
Agila	00>08	510	450	x	x
Agila	03.08>	550	410	x	x
Ampera	2012>	650	650	x	
Antara	05.06>	600	410	x	x
Astra/SW	09.91>02.98	450	450	x	x
Astra/GTC/Twin Top/SW	03.04>08.09	550	450	x	
Astra/S.Tourer/4 porte/GTC	09.09>	700	600	x	
Astra (TUTTE)	09.97>12.05	510	480	x	x
Combo (con port. post. diviso)	10.01>2011	510	450	x	
Combo	2012>	510	410	x	x
Corsa B 3p./5p.	03.93>09.00	450	450	x	x
Corsa C	09.00>09.06	510	450	x	x
Corsa D	07.06>	650	410	x	
Frontera	10.98>2005	480	480	x	x
Insignia/Sports Tourer	09.08>	600	450	x	x
Meriva	04.10>	700	550	x	
Meriva	03.03>03.10	600	600	x	x
Mokka	09.12>	650	350	x	
Movano	04.10>	650	650	x	x
Omega B	09.93>09.03	600	480	x	x
Signum	05.03>09.08	600	480	x	x
Tigra	09.94>08.99	450	450	x	x
Tigra TwinTop	06.04>2009	510	450	x	x
Vectra	88>2003	480	480	x	x
Vectra C / SW	09.01>10.08	600	480	x	x
Vectra S.W.	09.95>09.03	480	480	x	x
Vivaro (con port post.)	03.01>	600	530	x	x
Zafira	07.05>2011	700	550	x	
Zafira	03.99>07.05	600	600	x	x
PEUGEOT					
106	07.95>05.05	510	450	x	x
107	06.05>	650		x	x
205	10.87>09.98	450	450	x	x
206/Plus/CC/SW	06.98>	650	410	x	x
208	01.12>	650	410	x	
306/ Break	01.93>10.03	550	510	x	x
406 Tutte	10.95>03.04	600	550	x	x
806	06.94>08.02	650	510	x	x
807	08.05>	650	650	x	x
1007	04.05>2010	600	450	x	x
4007	09.07>	600	530	x	x
4008	03.12>	600	530	x	
206 - tutte	06.98>02.09	650	410	x	x
207 - tutte	05.06>	650	410	x	
307 - 307 S.W.	08.00>2008	700	650	x	
307 CC	10.03>05.05	700	600	x	
307 CC	06.05>2009	700	650	x	
308/SW/CC	2008>	700	650	x	
405 / SW	01.87>10.96	550	550	x	x
406 / SW	10.95>06.04	600	550	x	x
406 coupé	03.97>02.05	650	510	x	x

SPAZZOLE TERGICRISTALLI - WIPER BLADES APPLICATIVO



MARCA E MODELLO	ANNO	MISURA	MISURA	SPAZZOLA FLAT IN GOMMA CON ADATTATORI	SPAZZOLA TRADIZIONALE CON TELAIO IN METALLO PER ATTACCO A U/BAIONETTA
406 S.W.	10.96>06.04	600	550	x	x
407 - tutte	05.04>2010	700	700	x	
408	05.10>	700	650	x	
508/SW	2010>	650	650	x	
Bipper	02.08>	650	480	x	
Boxer	02.94>06.06	550	530	x	x
Boxer	06.06>	650	550	x	
Expert	05.98>01.07	650	510	x	x
Expert	09.95>2008	700	510	x	
Ion	10.10>	700		x	
Partner	05.08>	650	410	x	
Partner (2 porte)	07.96>04.08	550	530	x	x
Ranch (2 porte)	07.97>2008	550	530	x	x
RCZ	01.10>	650	650	x	
PORSCHE					
911	09.93>08.97	450	410	x	x
928/944 /968	08.91>11.95	480	480	x	x
911 e GT2	09.97>09.05	550	530	x	x
911 GT3	08.04>	550	530	x	x
Cayman	11.05>01.09	550	530	x	x
Panamera	03.09>	600	530	x	x
Macan	2014>	500	550	x	
Boxter	10.96>2012	550	530	x	x
Carrera 2 (966)	97>	550	550	x	x
Cayenne	09.02>	650	650	x	
RENAULT					
Captur	2013>	650	330	x	
Clio I	03.94>02.98	510	510	x	x
Clio II	03.98>05.09	530	450	x	x
Clio II Storia	06.09>	510	450	x	
Clio III	06.07>2013	600	410	x	
Clio IV/Grandtour	04.13>	650	350	x	
Espace IV	11.02>	700	650	x	
Express	03.86>10.97	450	450	x	x
Fluence	11.09	600	410	x	
Kangoo I (con porta post.)	10.97>12.07	510	480	x	x
Kangoo II (fiss. gancio)	01.08>	550	530	x	x
Koleos	09.08>	600	480	x	x
Laguna I - tutte	01.94>03.01	600	450	x	x
Laguna II / Grandtour	03.01>09.07	600	510	x	x
Laguna III/GrandTour	07.07>	650	410	x	
Laguna III coupe	02.07>	650	410	x	
Megane I - tutte	01.96>10.02	550	510	x	x
Megane II - tutte	02.02>2006	600	450	x	x
Megane II - tutte	02.06>10.09	600	450	x	
Megane III - tutte	11.08>	600	410	x	
Modus	06.04>2012	700	650	x	
Safrane	04.92>12.00	600	600	x	x
Scenic I	01.96>04.03	600	410	x	x
Scenic II	12.04>04.09	650	650	x	
Scenic III	05.09	700	650	x	
Trafic (con port. post.)	05.01>	600	530	x	x
Trafic L45	09.80>10.97	450	450	x	x
Twingo I	03.93>05.07	650		x	x
Twingo II	04.07>	600	410	x	
Twizy	2012>	450		x	x
Wind	2010>	600	410	x	x
Zoe	2013>	600	350		
ROVER					
25/200	1989>05.05	450	450	x	x
45/Serie 400	10.95>05.05	510	450	x	x
75 - 75 Tourer	01.99>05.05	550	530	x	x
City Rover	09.03>05.05	510	480	x	x
Serie 410/45	10.95>05.05	510	450	x	x

MARCA E MODELLO	ANNO	MISURA	MISURA	SPAZZOLA FLAT IN GOMMA CON ADATTATORI	SPAZZOLA TRADIZIONALE CON TELAIO IN METALLO PER ATTACCO A U/BAIONETTA
Serie 600	04.93>09.00	550	510	x	x
Serie 800	10.91>09.99	510	510	x	x
SAAB					
9-3/Coupè/Cabrio	03.98>08.03	530	510	x	x
900	09.93>10.98	530	510	x	x
9-3/Coupè/Cabrio/SW	08.03>2008	550	550	x	x
9-3/Coupè/Cabrio/SW/X	02.08>2012	600	550	x	
9-5 / 9-5 S.W.	06.97>08.07	550	550	x	x
9-5 II	08.10>2012	600	530	x	x
SSANGYONG					
Actyon	11.06>2012	530	480	x	x
Korando	07.96>12.05	450	450	x	x
Korando	2010>	600	410	x	x
Kyron	09.05>2011	550	480	x	x
Musso	07.93>12.05	510	450	x	x
Rexton/Rexton II	09.02>	510	510	x	x
Rodius	04>2011	600	450	x	x
SEAT					
Alhambra	07.01>2010	700	700	x	
Alhambra	2010>	700	410	x	
Altea (tutte)	05.06>	650	650	x	
Arosa	02.97>02.99	480	480	x	x
Arosa	03.99>06.04	530	480	x	x
Cordoba/Vario	93>06	530	480	x	x
Cordoba	06>09	530	480	x	
Exeo/Exeo ST	12>08	650	650	x	
Ibiza	06.84>05.93	450		x	x
Ibiza	03.93>02.06	530	480	x	x
Ibiza	03.06>02.08	530	480	x	
Ibiza/Sport coupé/ST	02.08>	600	410	x	
Mii	2012>	600	380	x	
Leon	10.98>06.06	530	480	x	x
Leon	07.06>	650	650	x	
Malaga	12.98>12.93	450	450	x	x
Toledo	04.99>07.04	530	480	x	x
Toledo	05.91>03.99	510	510	x	x
Toledo	09.04>	650	650	x	
SKODA					
Citigo	2012>	600	380	x	
Fabia e S.W.	09.99>12.06	530	480	x	x
Fabia e S.W.	12.06>	530	530	x	
Favorit	09.94>12.98	510	510	x	x
Felicia/Felicia SW	10.94>08.01	510	510	x	x
Octavia SW	05.04>	600	480	x	
Octavia/SW	09.96>2004	530	480	x	x
Rapid	07.12>	600	380	x	
Roomster	03.06>	530	530	x	
Superb/SW	03.08>	600	450	x	
Superb	12.01>10.04	550	480	x	
Superb	11.04>03.08	530	510	x	x
Yeti	05.09>	600	480	x	
SMART					
Cabrio / Coupé	07.98>01.04	530	530	x	x
Forfour	01.04>06.07	650	450	x	x
Fortwo cabrio/coupé	02.04>03.07	530	530	x	
Fortwo cabrio/coupé	04.07>	600	530	x	
Roadster	04.03>11.05	510	450	x	x
SUBARU					
BRZ	2012>	550	510	x	x
Forester	01.97>11.07	530	480	x	x
Forester	12.07>	600	450	x	x
Impreza 4p.	93>00	530	450	x	x
Impreza4p/SW/Outback	10.00>06.07	550	410	x	x
Impreza 4p.	07.07>	600	410	x	x
Justy	09.03>08.07	480	450	x	x
Justy	09.07>	510	410	x	x
Justy	10.95>09.03	530	450	x	x



MARCA E MODELLO	ANNO	MISURA	MISURA	SPAZZOLA FLAT IN GOMMA CON ADATTATORI	SPAZZOLA TRADIZIONALE CON TELAIO IN METALLO PER ATTACCO A U/BAIONETTA
Legacy/SW	07.03>05.09	600	450	x	x
Legacy/SW/Outback	06.09>	650	480	x	x
Legacy/Outback	98>2003	550	510	x	x
Tribeca	04.06>2012	650	510	x	x
XV	09.11>	650	410	x	x
SUZUKI					
Alto	02.02>12.06	450	410	x	x
Alto	10.94>02.02	480	450	x	x
Alto	01.09>	550	350	x	x
Baleno 4/5p/SW	04.95>09.05	510	450	x	x
Carry	10.94>03.99	350	350	x	x
Carry	03.99>03.09	410	410	x	x
Grand Vitara	03.98>	480	480	x	x
Ignis	10.00>12.07	450	450	x	x
Jimny	10.98>	410	410	x	x
Kizashi	06.10>	600	510	x	x
Liana	03.01>12.07	550	480	x	x
Splash	01.08>	550	410	x	x
Swift 3/4/5p	03.96>	530	450	x	x
Swift 4p.	09.91>09.95	510	450	x	x
SX4	05.06>2013	650	350	x	x
Vitara	88>98	450	450	x	x
Wagon R+	10.96>03.06	510	450	x	x
TATA					
Indica	10.98>12.01	550	550	x	x
Indica	01.02>10.06	510	510	x	x
Indica	11.06>	600	410	x	x
Xenon	2008>	510	510	x	x
Safari	08.98>	600	510	x	x
Vista	2008>	510	510	x	x
TOYOTA					
4Runner	95>2004	450	450	x	x
Auris	10.06>	650	410	x	x
Avensis W.	01.03>10.08	600	410	x	x
Avensis/Verso	05.01>10.08	650	410	x	x
Aygo	02.05>	650		x	x
Camry	08.01>01.06	550	510	x	x
Camry	01.06>	600	510	x	x
Camry	08.11>	650	450	x	x
Camry Wagon	06.91>08.96	530	450	x	x
Carina E	02.92>10.97	530	450	x	x
Celica Cabrio/Liftback	11.93>08.99	530	480	x	x
Celica Coupé	08.99>09.05	650	410	x	x
Corolla	11.06>	650	350	x	x
Corolla	08.00>2006	550	480	x	x
Corolla Verso	09.01>2009	650	410	x	x
Corolla Wagon	04.97>09.01	510	450	x	x
Corolla Wagon	08.00>2007	600	410	x	x
Corolla/hatchback/4p	05.92>2007	510	450	x	x
GT86	04.12>	550	510	x	x
Hilux	01.98>12.02	450	450	x	x
Hilux	06.05>	530	480	x	x
Iq	11.08>	530	450	x	x
Land Cruiser J15	08.09>	650	510	x	x
Land Cruiser J20	09.07>	600	550	x	x
Land Cruiser 80 (J8)	01.90>01.98	450	450	x	x
Land Cruiser J10	01.98>08.07	410	410	x	x
Land Cruiser 90 (J9)	04.96>12.06	480	450	x	x
Land Cruiser J12	09.02>08.09	550	530	x	x
Land Cruiser J7	01.90>08.99	410	410	x	x
MR 2 Cabrio	12.99>08.05	510	480	x	x
Paseo	04.94>08.00	510	450	x	x
Picnic	09.96>05.01	600	410	x	x
Previa	02.00>01.06	700	450	x	x
Prius	12.97>08.03	600	410	x	x
Prius	09.03>	650	410	x	x
Prius +	03.12>	650	380	x	x

MARCA E MODELLO	ANNO	MISURA	MISURA	SPAZZOLA FLAT IN GOMMA CON ADATTATORI	SPAZZOLA TRADIZIONALE CON TELAIO IN METALLO PER ATTACCO A U/BAIONETTA
Rav 4	11.05>2013	600	410	x	x
Rav 4	04.94>08.00	510	450	x	x
Rav 4	05.00>11.05	600	480	x	x
Rav 4	2013>	650	410	x	x
Urban Cruiser	01.09>	600	350	x	x
Verso	02.09>	650	410	x	x
Yaris	01.99>08.05	530	380	x	x
Yaris	08.05>2011	600	350	x	x
Yaris	2011>	650	330	x	x
Yaris Verso	08.99>09.05	550	410	x	x
VOLKSWAGEN					
Amarok	2010>	600	550	x	x
Bora/Variant	09.98>05.02	530	480	x	x
Bora/Variant	06.02>05.05	530	450	x	
Caddy	02.04>	600	450	x	
Caddy	11.95>06.03	530	450	x	x
Caddy Pick-Up	06.96>12.00	530	450	x	x
California / Caravelle T5	09.09>	600	550	x	x
California / Caravelle T5	02.03>11.09	600	600	x	
California Caravelle T4	09.90>06.03	530	530	x	x
CC	11.11>	600	480	x	
Crafter	04.06>	650	600	x	
Eos	05.06>	600	480	x	
Fox	04.05>2011	530	380	x	x
Golf I/II anche Cabrio	74>83	410	410	x	x
Golf III	11.91>12.97	530	480	x	x
Golf III cabrio	09.93>04.98	530	480	x	x
Golf III Variant	07.93>02.99	530	480	x	x
Golf IV	10.97>05.02	530	480	x	x
Golf IV	06.02>06.06	530	450	x	
Golf IV Cabriolet	04.98>06.02	530	480	x	x
Golf IV Variant	05.99>05.02	530	480	x	x
Golf IV Variant	06.02>06.06	530	450	x	x
Golf Plus	01.05>	700	700	x	
Golf V	10.03>11.08	600	480	x	
Golf V Variant	05.07>2012	600	480	x	x
Golf VI e Variant	10.08>2012	600	480	x	x
Golf VII	2013>	600	480	x	
Jetta	11.92>12.99	530	480	x	x
Jetta	01.05>11.10	600	480	x	x
Jetta	02.11>	600	480	x	
LT	05.96>04.06	600	530	x	x
Lupo	06.03>07.05	480	450	x	x
Lupo	06.98>05.03	530	480	x	x
Maggiolino	2012>	530	530	x	
Multivan T5	02.03>	600	600	x	
Multivan/TransporterT4	09.90>06.03	530	530	x	x
New Beetle	01.98>2011	530	530	x	x
Passat/Variant	04.88>10.01	530	530	x	x
Passat/Variant	11.01>05.05	550	480	x	x
Passat/Variant	03.05>2010	600	480	x	
Passat/Variant	08.11>	600	480	x	
Passat CC	05.08>2011	600	480	x	
Polo	09.01>05.05	530	410	x	
Polo	10.94>09.01	480	480	x	x
Polo	05.05>04.09	530	480	x	
Polo	06.09>	600	410	x	
Polo Classic/Variant	11.95>09.01	530	450	x	x
Polo Classic	10.90>09.94	410	410	x	x
Polo Classic/Variant	11.95>09.01	530	450	x	x
Scirocco	08.08>	600	480	x	x
Sharan	06.01>	700	700	x	
Sharan	05.10>	700	410	x	
Tiguan	11.07>	600	530	x	
Touareg	11.02>2010	650	650	x	
Touareg	2010>	650	650	x	

MARCA E MODELLO	ANNO	MISURA	MISURA	SPAZZOLA FLAT IN GOMMA CON ADATTATORI	SPAZZOLA TRADIZIONALE CON TELAIO IN METALLO PER ATTACCO A U/BAIONETTA
Touran (con bracci tergi a movimento opposto)	02.03>11.06	700	700	x	
Touran (con bracci tergi a movimento opposto)	11.06>	700	700	x	
Touran (mov. parallelo)	02.03>11.06	600	480	x	
Touran (mov. parallelo)	11.06>	600	480	x	
Transporter T3	05.79>07.92	450	450	x	x
Transporter T4	09.90>06.03	530	530	x	x
Transporter T5	02.03>11.09	600	600	x	
Transporter T5	09.09>	600	550	x	x
Vento	11.91>12.97	530	480	x	x
Up!	2012>	600	410	x	
VOLVO					
240	85>93	450	450	x	x
480	88>96	530	530	x	x
740	88>95	510	510	x	x
940	09.90>10.98	510	510	x	x
960	08.90>07.98	530	530	x	x
850 S.W.	09.91>07.98	530	530	x	x
C30	10.06>	650	510	x	
C70 / Cabrio	02.98>03.06	530	530	x	x
C70 / Cabrio	03.06>	650	480	x	
S40	12.03>07.12	650	510	x	
S40 / V40	09.95>01.04	510	510	x	x
S60	11.00>07.04	600	530	x	x
S60	08.04>07.09	650	510	x	
S60/V60	08.10>	650	510	x	
S70	01.97>07.00	530	530	x	x
S80	06.98>07.04	600	530	x	x
S80	08.04>07.06	600	530	x	
S80	03.06>	650	510	x	
V40	08.12>	650	480	x	
V50	04.04>07.05	650	510	x	
V50	08.05>	650	510	x	
V70	01.97>03.00	530	530	x	x
V70	03.00>07.03	600	530	x	x
V70	08.03>07.07	600	530	x	
V70	08.07>	650	510	x	
V90	01.97>07.98	530	530	x	x
XC60	03.09>	650	510	x	
XC70	08.02>07.04	600	530	x	x
XC70	08.04>07.07	600	530	x	
XC70	08.07>	650	510	x	
XC90	10.02>07.04	600	530	x	x
XC90	08.04>	600	530	x	



ESPOSITORE DA TERRA

0011

MASSIMA CAPACITÀ 45 PEZZI

ASSORTIMENTI VARI

L'espositore in cartone viene fornito senza prodotto.



VISTA LATERALE



VISTA FRONTALE

La ricerca, lo sviluppo e il continuo miglioramento tecnologico, garantiscono da anni le migliori prestazioni dei nostri tergicristalli TOP.

ESPOSITORE METALLO CON RUOTE

18535

MASSIMA CAPACITÀ 120 PEZZI

ASSORTIMENTI VARI







ILLUMINAZIONE CAR LIGHTING

SUPPORTO VENDITA LINEA ILLUMINAZIONE



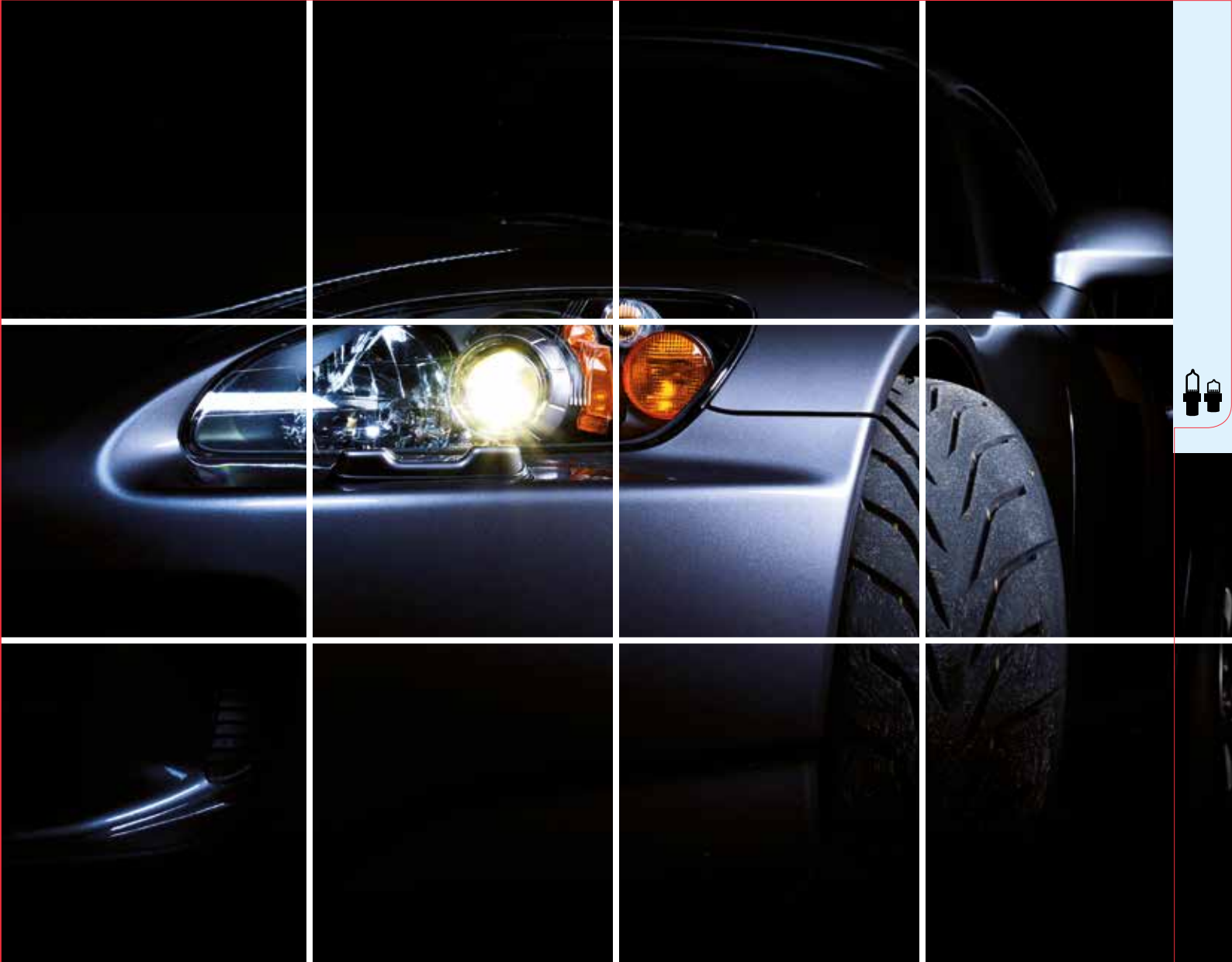

ILLUMINAZIONE

CAR LIGHTING

LAMPADE GOODYEAR	pag 116
LAMPADE XTRA	pag 119
LAMPADE BOTTARI	pag 121
TROUSSE E LAMPADE MICRO BOTTARI	pag 125
LAMPADE XTRA	pag 126
LUCI GOODYEAR	pag 129
LUCI XTRA-LAMPADINA MOTO	pag 130
ESPOSITORI - GUIDA APPLICAZIONE LAMPADE	pag 131



SILVER HEADLIGHT BULB

77007 a 77009

H1 H4 H7

- LUCE BIANCA POTENTISSIMA
- EXTREMELY POWERFUL WHITE LIGHT
- LUMIÈRE BLANCHE TRÈS PUISSANTE
- Sehr starkes, weiß Licht
- LUZ BLANCA POTENTE



1 PC



(E)

Approved

	LAMPS	V	H	W	MASTER	INNER
77007	1	12	H1	55	120	12
77008	1	12	H4	60/55	120	12
77009	1	12	H7	55	120	12



PLATINUM HEADLIGHT BULB

77010 a 77015

H1 H4 H7

- LUCE BIANCA POTENTISSIMA
- EXTREMELY POWERFUL WHITE LIGHT
- LUMIÈRE BLANCHE TRÈS PUISSANTE
- Sehr starkes, weiß Licht
- LUZ BLANCA POTENTE



(E)

Approved

1 PC

	LAMPS	V	H	W	MASTER	INNER
77010	1	12	H1	55	120	12
77011	1	12	H4	60/55	120	12
77012	1	12	H7	55	120	12
77013	2	12	H1	55	60	6
77014	2	12	H4	60/55	60	6
77015	2	12	H7	55	60	6

2 PCS



ULTRA CRYSTAL WHITE HEADLIGHT BULB

77016 a 77018

- LUCE BIANCA POTENTISSIMA
- EXTREMELY POWERFUL WHITE LIGHT
- LUMIÈRE BLANCHE TRÈS PUISSANTE
- Sehr starkes, weiß Licht
- LUZ BLANCA POTENTE



H1 H4 H7

2 PCS



Approved

	LAMPS	V	H	W	MASTER	INNER
77016	2	12	H1	55	60	6
77017	2	12	H4	60/55	60	6
77018	2	12	H7	55	60	6



ULTRA BLUE VISION HEADLIGHT BULB

77019 a 77021

- LUCE BIANCA POTENTISSIMA
- EXTREMELY POWERFUL WHITE LIGHT
- LUMIÈRE BLANCHE TRÈS PUISSANTE
- Sehr starkes, weiß Licht
- LUZ BLANCA POTENTE



H1 H4 H7

2 PCS



Approved

	LAMPS	V	H	W	MASTER	INNER
77019	2	12	H1	55	60	6
77020	2	12	H4	60/55	60	6
77021	2	12	H7	55	60	6



KIT 2 LAMPADE

77025

BA 15 S

- LAMPADE A 1 LUCE PER SEGNALATORI 12V 21W-BA 15 S BLISTER
- TWIN FILAMENT INDICATOR BULB 12V 21W-BA 15 S BLISTER
- AMPOULE À 1 FEU POUR SIGNALISATEURS 12V 21W-BA 15 S EN BLISTER
- 1-Licht-Lampe für Blinker 12V 21W-BA 15 S in Luftpolsterfolienverpackung
- LÁMPARA 12V 21W-BA 15 S 1 FILAMENTO BLISTER 2 PZ



Approved



12V 21W

MASTER 240 INNER 12



KIT 2 LAMPADE

77026

BAY 15 D

- LAMPADE A 2 LUCI PER SEGNALATORI 12V 5/21W-BAY 15 D BLISTER
- TWIN FILAMENT INDICATOR BULB 12V 5/21W-BAY 15 D BLISTER
- AMPOULE À 2 FEUX POUR SIGNALISATEURS 12V 5/21W-BAY 15 D EN BLISTER
- 2-Licht-Lampe für Blinker 12V 5/21W-BAY 15 D in Luftpolsterfolienverpackung
- LÁMPARA BAY15D - 5/21W 12V 5/21W-BAY 15 D BLISTER



Approved



12V 5/21W

MASTER 240 INNER 12



KIT 2 LAMPADE

77027



BA 15 S



12V 5W



- LAMPADE SFERICHE PER FANALI 12V-5W-BA 15 S BLISTER
- ROUND LIGHT BULBS FOR HEADLIGHT CLUSTERS, 12V-5W-BA 15 S BLISTER
- AMPOULES SPHÉRIQUES POUR PHARES 12V-5W-BA 15 S EN BLISTER
- Kugellampen für Rücklichter 12V-5W-BA 15 S in Luftpolsterfolienverpackung
- LÁMPARA 12V-5W-BA 15 S BLISTER 2 PZ

MASTER 240 INNER 12

KIT 2 LAMPADE

77029



T 10



12V 5W

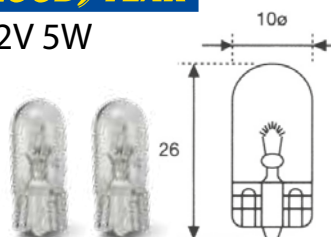

- LAMPADA MICRO PER INDICATORI 12V-5W TUTTO VETRO ATTACCO T10 BLISTER
- MICRO BULBS FOR INDICATORS, 12V-5W SOLID GLASS, T10 FITTING BLISTER
- AMPOULES MICRO POUR CLIGNOTANTS 12V-5W VERRE FIXATION T10 EN BLISTER
- Mikrolampen für Blinker 12v-5w ganz aus Glas Sockel T10
- LÁMPARA T-10 5W - 12 V BLISTER 2 PZ

MASTER 240 INNER 12

12V 5W

KIT 2 LAMPADE

77031



11x38



12V 5W

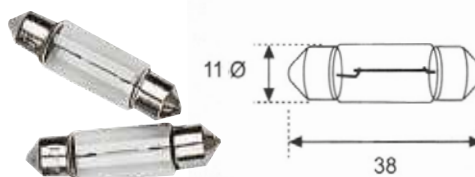

- LAMPADA SILURO 12V ATTACCO 11X38 BLISTER
- TORPEDO BULB, 12V 11X38 FITTING BLISTER
- AMPOULE TORPILLE 12V FIXATION 11X38 EN BLISTER
- Torpedolampe 12V Sockel 11x38 in Luftpolsterfolienverpackung
- LÁMPARA PLAFON 5W - 11X38 - 12V BLISTER 2 PZ

MASTER 240 INNER 12

LAMPADA H1

77022



P 14,5 S



12V 55W



- LAMPADA ALOGENA PER FARI ANTERIORI
- HALOGEN BULB FOR FRONT LIGHT
- AMPOULE HALOGÈNE POUR PROJECTEURS AVANT
- Halogenlampe für Frontscheinwerfer
- LÁMPARA HALÓGENA PARA FAROS DE LANTEROS

MASTER 100 INNER 10

LAMPADA H4

77023



P 43 T



12V 60-55W



- LAMPADA ALOGENA PER FARI ANTERIORI
- HALOGEN BULB FOR FRONT LIGHT
- AMPOULE HALOGÈNE POUR PROJECTEURS AVANT
- Halogenlampe für Frontscheinwerfer
- LÁMPARA HALÓGENA PARA FAROS DE LANTEROS

MASTER 100 INNER 10

LAMPADA H7

77024



PX 22 D



12V 55W



- LAMPADA ALOGENA PER FARI ANTERIORI
- HALOGEN BULB FOR FRONT LIGHT
- AMPOULE HALOGÈNE POUR PROJECTEURS AVANT
- Halogenlampe für Frontscheinwerfer
- LÁMPARA HALÓGENA PARA FAROS DE LANTEROS

MASTER 100 INNER 10

**LA PIÙ VENDUTA
QUALITÀ PRIMO IMPIANTO**

LAMPADE SUPER WHITE

30510 a 30518

- LUCE BIANCA POTENTISSIMA
- EXTREMELY POWERFUL WHITE LIGHT
- LUMIÈRE BLANCHE TRÈS PUISSANTE
- Sehr starkes, weiß Licht
- LUZ BLANCA POTENTE

H1 H3 H4
H5 H7

	LAMPS	V	H	W	MASTER	INNER
30510	2	12	H1	55	48	12
30511	2	12	H1	130	48	12
30512	2	12	H3	55	48	12
30514	2	12	H4	60/55	48	12
30516	2	12	H5	160/55	48	12
30518	2	12	H7	55	48	12



(E)
Approved



2 PCS



- LUCE BIANCA LIMPIDISSIMA (SIMILE A QUELLA SOLARE)
- FORTE EFFETTO ULTRAVIOLETTO
- BASE D'ATTACCO IN ACCIAIO INOX RESISTENTE ALLE ALTE TEMPERATURE
- CONTRASSEGNALE DAL MARCHIO E

- EXTREMELY CLEAR WHITE LIGHT (SIMILAR TO SUNLIGHT)
- STRONG ULTRAVIOLET EFFECT
- BASE FOR ATTACHMENT IN STAINLESS STEEL RESISTANT TO HIGH TEMPERATURES
- MARKED WITH THE SIGN E

LAMPADE RAINBOW BLUE

30500-30502-30504-30508

- LUCE BIANCA POTENTISSIMA
- EXTREMELY POWERFUL WHITE LIGHT
- LUMIÈRE BLANCHE TRÈS PUISSANTE
- Sehr starkes, weiß Licht
- LUZ BLANCA POTENTE

H1 H3
H4 H7

	LAMPS	V	H	W	MASTER	INNER
30500	2	12	H1	55	48	12
30502	2	12	H3	55	48	12
30504	2	12	H4	60/55	48	12
30508	2	12	H7	55	48	12



(E)
Approved



2 PCS



- LUCE BIANCA/BLU POTENTISSIMA
- FORTE EFFETTO ULTRAVIOLETTO
- BASE D'ATTACCO IN ACCIAIO INOX RESISTENTE ALLE ALTE TEMPERATURE
- CONTRASSEGNALE DAL MARCHIO E

- EXTREMELY POWERFUL WHITE/BLUE LIGHT
- STRONG ULTRAVIOLET EFFECT
- BASE FOR ATTACHMENT IN STAINLESS STEEL RESISTANT TO HIGH TEMPERATURES
- MARKED WITH THE E SIGN

LAMPADA H1

30580



H1



- LAMPADA ALOGENA H1 12V 55W BLISTER
- HALOGEN LAMP H1 12V 55W BLISTER
- LAMPE HALOGÈNE H1 12V 55W EN BLISTER
- Halogenlampe H1 12V 55W in Luftpolsterfolienverpackung
- LÁMPARA H1 12V 55W BLISTER

+50% DI LUMINOSITÀ 12V 55W

MASTER 120 INNER 12

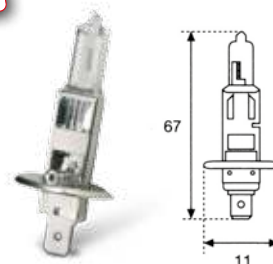

LAMPADA H4

30582



H4



- LAMPADA ALOGENA H4 12V 60/55W P43t BLISTER
- HALOGEN LAMP H4 12V 60/55W P43t BLISTER
- LAMPE HALOGÈNE H4 12V 60/55W P43t EN BLISTER
- Halogenlampe H4 12V 60/55W P43t in Luftpolsterfolienverpackung
- LÁMPARA H4 12V 60/55W P43t BLISTER

+50% DI LUMINOSITÀ 12V 60/55W P43t

MASTER 120 INNER 12

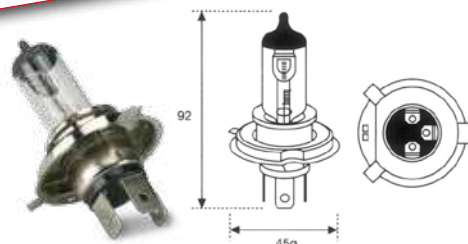

LAMPADA H5

30586



H5



- LAMPADA ALOGENA H5 12V 60/55W P45t BLISTER
- HALOGEN LAMP H5 12V 60/55W P45t BLISTER
- LAMPE HALOGÈNE H5 12V 60/55W P45t EN BLISTER
- Halogenlampe H5 12V 60/55W P45t in Luftpolsterfolienverpackung
- LÁMPARA H5 12V 60/55W P45t BLISTER

+50% DI LUMINOSITÀ 12V 60/55W P45t

MASTER 120 INNER 12



LAMPADA H7

30584



H7



- LAMPADA ALOGENA H7 12V 55W BLISTER
- HALOGEN LAMP H7 12V 55W BLISTER
- LAMPE HALOGÈNE H7 12V 55W EN BLISTER
- Halogenlampe H7 12V 55W in Luftpolsterfolienverpackung
- LÁMPARA H71 12V 55W BLISTER

+50% DI LUMINOSITÀ 12V 55W

MASTER 120 INNER 12

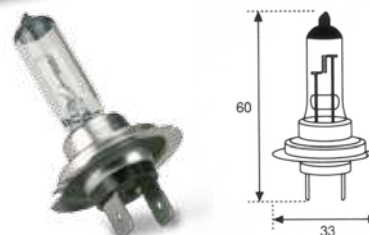

LAMPADE A SILURO

30578

10.5x44



- LAMPADE SILURO, ATTACCO. INDICATE PER: LUCI CRUSCOTTO
- TORPEDO BULB. INDICATED FOR: DASHBOARD LIGHTS
- AMPOULE TORPILLE FIXATION. PRINCIPALES UTILISATIONS: ECLAIRAGE DU TABLEAU DE BORD
- Torpedolampe sockel. Lampen für: armaturenbrettbeleuchtung
- LÁMPARA CASQUILLO CONEXIÓN. PRINCIPALES APLICACIONES: ILUMINACION DEL SALPICADERO

VETRO BLU - LED BIANCO



12V 5W

MASTER 100 INNER 10



LAMPADA H1

30562



Approved

H1

- LAMPADA ALOGENA H1 12V 55W BLISTER
- HALOGEN LAMP H1 12V 55W BLISTER
- LAMPE HALOGÈNE H1 12V 55W EN BLISTER
- Halogenlampe H1 12V 55W in Luftpolsterfolienverpackung
- LÁMPARA H1 12V 55W BLISTER

+30% DI LUMINOSITÀ 12V 55W

MASTER 120 INNER 12

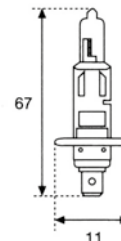

LAMPADA H4

30563



Approved

H4

- LAMPADA ALOGENA H4 12V 60/55W P43t BLISTER
- HALOGEN LAMP H4 12V 60/55W P43t BLISTER
- LAMPE HALOGÈNE H4 12V 60/55W P43t EN BLISTER
- Halogenlampe H4 12V 60/55W P43t in Luftpolsterfolienverpackung
- LÁMPARA H4 12V 60/55W P43t BLISTER

+30% DI LUMINOSITÀ 12V 60/55W P43t

MASTER 120 INNER 12

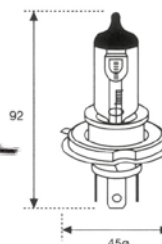

LAMPADA H5

30564



Approved

H5

- LAMPADA ALOGENA H5 12V 60/55W P45t BLISTER
- HALOGEN LAMP H5 12V 60/55W P45t BLISTER
- LAMPE HALOGÈNE H5 12V 60/55W P45t EN BLISTER
- Halogenlampe H5 12V 60/55W P45t in Luftpolsterfolienverpackung
- LÁMPARA H5 12V 60/55W P45t BLISTER

+30% DI LUMINOSITÀ 12V 60/55W P45t

MASTER 120 INNER 12

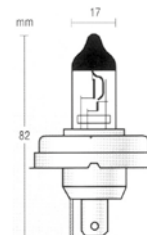

LAMPADA H7

30565



Approved

H7

- LAMPADA ALOGENA H7 12V 55W BLISTER
- HALOGEN LAMP H7 12V 55W BLISTER
- LAMPE HALOGÈNE H7 12V 55W EN BLISTER
- Halogenlampe H7 12V 55W in Luftpolsterfolienverpackung
- LÁMPARA H71 12V 55W BLISTER

+30% DI LUMINOSITÀ 12V 55W

MASTER 120 INNER 12

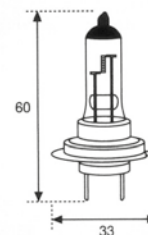

TORPEDO

17825



Approved

10x31

- 2 LAMPADINE SILURO LEDS
- 2 FESTOON BULBS LEDS
- COUPLE LAMPES TORPILLE LEDS
- 2 Torpedolampen mit Leuchtdioden
- 2 LÁMPARAS PLAFONIER DE LEDS

PER PLAFONIERA E LUCE TARGA

3 LED BIANCHI - WHITE LED

MASTER 500 INNER 50



MAGIC

13936

- COPPIA LUCI LED
- PAIR OF LED LIGHT
- COUPLE LUMIERE LED
- Led-Lichterpaar
- PAREJA LUCES LED

1 LED

MASTER 120 INNER 12

(E) **T10**
Approved

13936		bianco	white
-------	--	--------	-------



CHARM

13938 - 13939

- COPPIA LUCI 4 LED
- PAIR OF LIGHTS WITH 4 LEDS
- COUPLE LUMIÈRES 4 LEDS
- 4 Led-Lichterpaar
- PAREJA LUCES 4 LEDS

BIANCO

4 LED

MASTER 120 INNER 12

(E) **T10**
Approved

13938		blu	blue
13939		bianco	white



ENIGMA

17852

- COPPIA LAMPADE FANALI ANTERIORI
- PAIR OF BULBS FRONT LIGHTS
- COUPLE LAMPES FEUX ANTÉRIEURS
- Lampepaar Vorderlicht
- PAREJA LAMPARILLAS FAROS ANTERIORES

LUCE ACCESA ARANCIONE

MASTER 400 INNER 10

(E) **T10**
Approved

12V 5W

LA LUCE RIMANE ARANCIONE,
EFFETTO TRASPARENTE LUCE SPENTA

LIGHT KEEP AMBER COLOR ONLY
TRANSPARENT EFFECT LIGHT OFF



SUPER LIGHT

17855

- "SUPER LIGHT" LUCE A LED
- "SUPER LIGHT" IS A LED LAMP
- LA LUMIÈRE À HAUTE INTENSITÉ
- Das Licht mit hoher Intensität
- LA LUZ DE ALTA INTENSIDAD

12 LED BIANCHI - 12 LED WHITE

"SUPER LIGHT" LA LUCE A LED CHE ILLUMINA 5 VOLTE DI PIÙ DI UNA NORMALE LAMPADINA A FILAMENTO. È POSIZIONABILE IN VARI POSTI INTERNI ALL'AUTO COME LUCE PLAFONIERA, LUCE BAULE, LUCE PORTIERA.

"SUPER LIGHT" IS A LED LAMP WHICH GIVES OFF 5 TIMES MORE LIGHT THAN A NORMAL FILAMENT LIGHT BULB. IT CAN BE POSITIONED IN VARIOUS POINTS INSIDE THE MOTOR VEHICLE E.G. CEILING LIGHT, BOOT (TRUNK) LIGHT, DOOR LIGHT.



ESPOSITORE DA BANCO

17998

L'espositore viene fornito vuoto
MASTER 1 INNER 1

MASTER 50 INNER 10

LAMPADA H1

30129

(E) **H1**
Approved

- LAMPADA ALOGENA H1 12V 55W BLISTER
- HALOGEN LAMP H1 12V 55W BLISTER
- LAMPE HALOGÈNE H1 12V 55W EN BLISTER
- Halogenlampe H1 12V 55W in Luftpolsterfolienverpackung
- LÁMPARA H1 12V 55W BLISTER

MASTER 120 INNER 12

12V 55W



LAMPADA H4

30135

(E) **H4**
Approved

- LAMPADA ALOGENA H4 12V 60/55W P43t BLISTER
- HALOGEN LAMP H4 12V 60/55W P43t BLISTER
- LAMPE HALOGÈNE H4 12V 60/55W P43t EN BLISTER
- Halogenlampe H4 12V 60/55W P43t in Luftpolsterfolienverpackung
- LÁMPARA H4 12V 60/55W P43t BLISTER

MASTER 120 INNER 12

12V 60/55W P43t

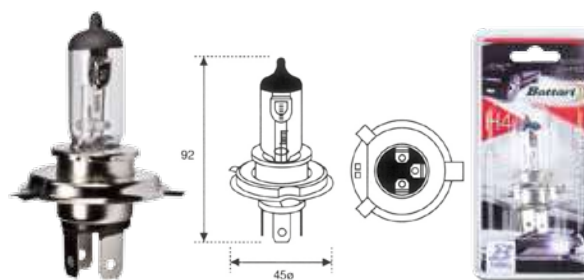

LAMPADA H5

30139

(E) **H5**
Approved

- LAMPADA ALOGENA H5 12V 60/55W P45t BLISTER
- HALOGEN LAMP H5 12V 60/55W P45t BLISTER
- LAMPE HALOGÈNE H5 12V 60/55W P45t EN BLISTER
- Halogenlampe H5 12V 60/55W P45t in Luftpolsterfolienverpackung
- LÁMPARA H5 12V 60/55W P45t BLISTER

MASTER 200 INNER 10

12V 60/55W P45t

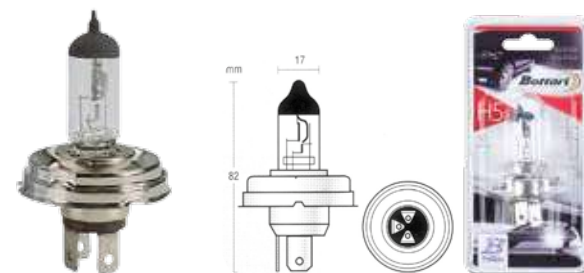

LAMPADA H7

30127

(E) **H7**
Approved

- LAMPADA ALOGENA H7 12V 55W BLISTER
- HALOGEN LAMP H7 12V 55W BLISTER
- LAMPE HALOGÈNE H7 12V 55W EN BLISTER
- Halogenlampe H7 12V 55W in Luftpolsterfolienverpackung
- LÁMPARA H7 12V 55W BLISTER

MASTER 120 INNER 12

12V 55W

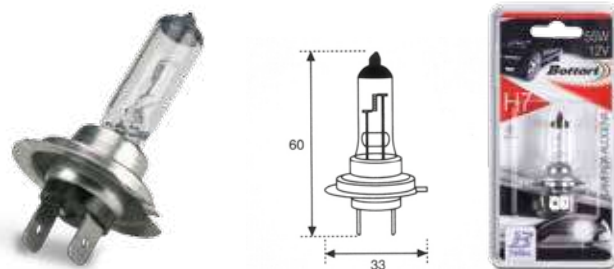

LAMPADA H3

30128

(E) **H3**
Approved

- LAMPADA ALOGENA H3 12V 55W BLISTER
- HALOGEN LAMP H3 12V 55W BLISTER
- LAMPE HALOGÈNE H3 12V 55W EN BLISTER
- Halogenlampe H3 12V 55W in Luftpolsterfolienverpackung
- LÁMPARA H3 12V 55W BLISTER

MASTER 100 INNER 10

12V 55W

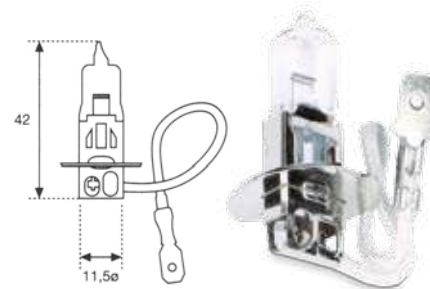

LAMPADA R2

30143

(E) **R2**
Approved

- LAMPADA ASIMMETRICA 12V 45/40W BLISTER
- DIPPED/MAIN BEAM BULB, 12V 45/40W BLISTER
- AMPOULE ASYMÉTRIQUE 2 FEUX 12V 45/40W EN BLISTER
- Asymmetrische 2-Licht-Lampe 12v 45/40w in Luftpolsterfolienverpackung
- LÁMPARA F.E. 12V 45/40W - BLISTER

MASTER 120 INNER 12

12V 45/40W

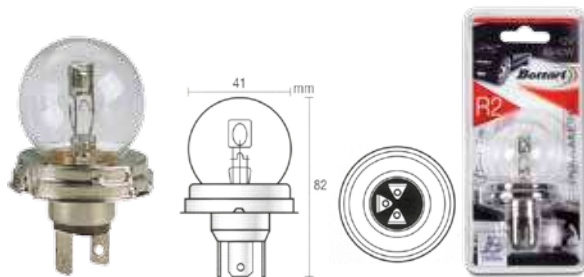

KIT 2 LAMPADE

30149



Approved

BAY 15 D

12V 5/21W

- LAMPADA A 2 LUCI PER SEGNALATORI 12V 5/21W-BAY 15 D BLISTER
- TWIN FILAMENT INDICATOR BULB 12V 5/21W-BAY 15 D BLISTER
- AMPOULE À 2 FEUX POUR SIGNALISATEURS 12V 5/21W-BAY 15 D EN BLISTER
- 2-Licht-Lampe für Blinker 12V 5/21W-BAY 15 D in Luftpolsterfolienverpackung
- LÁMPARA BAY15D - 5/21W 12V 5/21W-BAY 15 D BLISTER

MASTER 240 INNER 12



KIT 2 LAMPADE

30145



Approved

BA 15 S

12V 21W

- LAMPADA A 1 LUCE PER SEGNALATORI 12V 21W-BA 15 S BLISTER
- TWIN FILAMENT INDICATOR BULB 12V 21W-BA 15 S BLISTER
- AMPOULE À 1 FEU POUR SIGNALISATEURS 12V 21W-BA 15 S EN BLISTER
- 1-Licht-Lampe für Blinker 12V 21W-BA 15 S in Luftpolsterfolienverpackung
- LÁMPARA 12V 21W-BA 15 S 1 FILAMENTO blister 2 pz

MASTER 240 INNER 12



KIT 2 LAMPADE

30153



Approved

BA 15 S

12V 5W

- LAMPADA SFERICHE PER FANALI 12V-5W-BA 15 S BLISTER
- ROUND LIGHT BULBS FOR HEADLIGHT CLUSTERS, 12V-5W-BA 15 S BLISTER
- AMPOULES SPHÉRIQUES POUR PHARES 12V-5W-BA 15 S EN BLISTER
- Kugellampen für Rücklichter 12V-5W-BA 15 S in Luftpolsterfolienverpackung
- LÁMPARA 12V-5W-BA 15 S BLISTER 2 PZ

MASTER 240 INNER 12



KIT 2 LAMPADE

30157



Approved

T 10

12V 5W

- LAMPADA MICRO PER INDICATORI 12V-5W TUTTO VETRO ATTACCO T10 BLISTER
- MICRO BULBS FOR INDICATORS, 12V-5W SOLID GLASS, T10 FITTING BLISTER
- AMPOULES MICRO POUR CLIGNOTANTS 12V-5W VERRE FIXATION T10 EN BLISTER
- Mikrolampen für Blinker 12v-5w ganz aus Glas Sockel T10
- LÁMPARA T-10 5W - 12 V BLISTER 2 PZ

MASTER 240 INNER 12

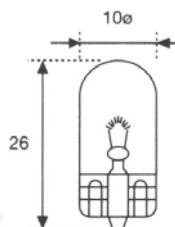

KIT 2 LAMPADE

30159



Approved

T 10

12V 3W

- LAMPADA MICRO PER INDICATORI 12V-3W TUTTO VETRO ATTACCO T10 BLISTER
- MICRO BULBS FOR INDICATORS, 12V-3W SOLID GLASS, T10 FITTING BLISTER
- AMPOULES MICRO POUR CLIGNOTANTS 12V-3W VERRE FIXATION T10 EN BLISTER
- Mikrolampen für Blinker 12v-3w ganz aus Glas Sockel T10 in Luftpolsterfolienverpackung
- LÁMPARA T-10 3W - 12 V BLISTER 2 PZ

MASTER 240 INNER 12

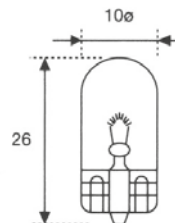

KIT 2 LAMPADE

30163



Approved

11x38

12V 5W

- LAMPADA SILURO 12V ATTACCO 11X38 BLISTER
- TORPEDO BULB, 12V 11X38 FITTING BLISTER
- AMPOULE TORPILLE 12V FIXATION 11X38 EN BLISTER
- Torpedolampe 12V Sockel 11x38 in Luftpolsterfolienverpackung
- LÁMPARA PLAFON 5W - 11X38 - 12 V BLISTER 2 PZ

MASTER 240 INNER 12

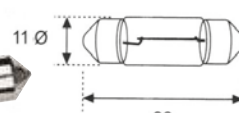

TROUSSE H7

28046



5 LAMPADINE + 2 FUSIBILI
5 LAMPS + 2 FUSES SET



- TROUSSE ALOGENA H7 OMOLOGATE COMPLETE DI FUSIBILI
- HOMOLOGATED H7 HALOGEN BULB KIT COMPLETE WITH FUSES
- TROUSSE AMPOULES H7 HOMOLOGUÉES AVEC FUSIBLES
- Satz zugelassener Lampen H7, komplett mit Sicherungen
- ESTUCHE LÁMPARAS H-7 55W - 5 PZ + 2 FUSIBLES

55W-PX26d

1 LAMPADA ALOGENA, 1 HALOGEN BULB	H7	PX26d	1 LAMPADA MICRO, MICRO BULB	R5W	BA15s
1 LAMPADA 2 FILAMENTI, TWIN FILAMENT BULB	P21/5W	BAY15d	1 LAMPADA MICRO, MICRO BULB	T4W	BA 9s
1 LAMPADA 1 FILAMENTO, SINGLE FILAMENT BULB	P21W	BA15s	2 FUSIBILI LAMELLARI, 2 LAMELLAR FUSES		10A-15A

MASTER 72 INNER 12

TROUSSE H4

28045



5 LAMPADINE + 2 FUSIBILI
5 LAMPS + 2 FUSES SET



- TROUSSE ALOGENA H4 OMOLOGATE COMPLETE DI FUSIBILI
- HOMOLOGATED H4 HALOGEN BULB KIT COMPLETE WITH FUSES
- TROUSSE AMPOULES H4 HOMOLOGUÉES AVEC FUSIBLES
- SATZ ZUGELASSENER LAMPEN H4, KOMPLETT MIT SICHERUNGEN
- ESTUCHE LÁMPARAS H-4 60/55W - 5 PZ + 2 FUSIBLES

60/55W P43t

1 LAMPADA ALOGENA, 1 HALOGEN BULB	H4	P43t	1 LAMPADA MICRO, MICRO BULB	R5W	BA15s
1 LAMPADA 2 FILAMENTI, TWIN FILAMENT BULB	P21/5W	BAY15d	1 LAMPADA MICRO, MICRO BULB	T4W	BA 9s
1 LAMPADA 1 FILAMENTO, SINGLE FILAMENT BULB	P21/5W	BA15s	2 FUSIBILI LAMELLARI, 2 LAMELLAR FUSES		10A-15A

MASTER 72 INNER 12

TROUSSE H1

28037



5 LAMPADINE + 2 FUSIBILI
5 LAMPS + 2 FUSES SET



- TROUSSE ALOGENA H1 OMOLOGATE COMPLETE DI FUSIBILI
- HOMOLOGATED H1 HALOGEN BULB KIT COMPLETE WITH FUSES
- TROUSSE AMPOULES H1 HOMOLOGUÉES AVEC FUSIBLES
- Satz zugelassener Lampen H1, komplett mit Sicherungen
- ESTUCHE LÁMPARAS H-1 55W - 5 PZ + 2 FUSIBLES

12V-55W-P14,5s

1 LAMPADA ALOGENA, 1 HALOGEN BULB	H1	P14,5s	1 LAMPADA MICRO, MICRO BULB	R5W	BA15s
1 LAMPADA 2 FILAMENTI, TWIN FILAMENT BULB	P21/5W	BAY15d	1 LAMPADA MICRO, MICRO BULB	T4W	BA 9s
1 LAMPADA 1 FILAMENTO, SINGLE FILAMENT BULB	P21W	BA15s	2 FUSIBILI LAMELLARI, 2 LAMELLAR FUSES		10A-15A

MASTER 72 INNER 12

TROUSSE H1+H7

28038



6 LAMPADINE + 2 FUSIBILI
6 LAMPS + 2 FUSES SET



- KIT TROUSSE CON LAMPADA ALOGENA H1-H7
- LAMPS TROUSSE WITH H1-H7 HALOGEN LAMP
- COFFRET DE LAMPES H1-H7
- Werkzeugsatz mit Halogenlampe H1-H7
- ESTUCHE DE LAMPARA HALÓGENA H1-H7

12V-55W

1 LAMPADA ALOGENA, 1 HALOGEN BULB	H1	P14,5	1 LAMPADA 1 FILAMENTO, SINGLE FILAMENT BULB	P21W	BA15s
1 LAMPADA ALOGENA, 1 HALOGEN BULB	H7	PX26d	1 LAMPADA MICRO, MICRO BULB	R5W	BA15s
1 LAMPADA 2 FILAMENTI, TWIN FILAMENT BULB	P21/5W	BAY15d	1 LAMPADA MICRO, MICRO BULB	T4W	BA 9s
			2 FUSIBILI LAMELLARI, 2 LAMELLAR FUSES		10A-15A

MASTER 72 INNER 12

10 LAMPADINE MICRO

30158



- LAMPADINE MICRO PER INDICATORI 12V-3W. TUTTO VETRO ATTACCO T10
- MICRO BULBS FOR INDICATORS, 12V-3W SOLID GLASS, T10
- AMPOULES MICRO POUR CLIGNOTANTS 12V-3W VERRE FIXATION T10
- MIKROLAMPEN FÜR BLINKER 12V-3W GANZ AUS GLAS SOCKEL T10
- LÁMPARA T-10 3W - 12V

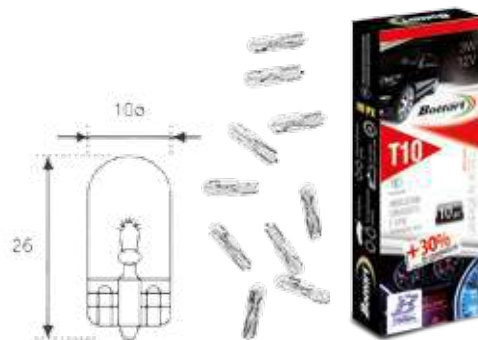

10 PEZZI

MASTER 2400 INNER 200

LAMPADA H1

30130X-30131X-30168X

(E) Approved **H1**



- LAMPADA ALOGENA PER FARI ANTERIORI
- HALOGEN BULB FOR FRONT LIGHT
- AMPOULE HALOGÈNE POUR PROJECTEURS AVANT
- Halogenlampe für Frontscheinwerfer
- LÁMPARA HALÓGENA PARA FAROS DE LANTEROS

30130X 12V 55W **30131X** 12V 70W **30168X** 24V 70W

MASTER 200 INNER 10



LAMPADA H4

30134X-30137X-30136X

(E) Approved **H4**



- LAMPADA ALOGENA PER FARI ANTERIORI
- HALOGEN BULB FOR FRONT LIGHT
- AMPOULE HALOGÈNE POUR PROJECTEURS AVANT
- Halogenlampe für Frontscheinwerfer
- LÁMPARA HALÓGENA PARA FAROS DE LANTEROS

30134X 12V 60-55W **30137X** 12V 100-80W **30136X** 24V 75-70W

MASTER 200 INNER 10



LAMPADA H7

30125X-30190X

(E) Approved **H7**



- LAMPADA ALOGENA PER FARI ANTERIORI
- HALOGEN BULB FOR FRONT LIGHT
- AMPOULE HALOGÈNE POUR PROJECTEURS AVANT
- Halogenlampe für Frontscheinwerfer
- LÁMPARA HALÓGENA PARA FAROS DE LANTEROS

30125X 12V 55W **30190X** 24V 70W

MASTER 100 INNER 10 MASTER 200 INNER 10



LAMPADA H3

30132X - 30169X

(E) Approved **H3**



- LAMPADA ALOGENA PER FARI ANTERIORI
- HALOGEN BULB FOR FRONT LIGHT
- AMPOULE HALOGÈNE POUR PROJECTEURS AVANT
- Halogenlampe für Frontscheinwerfer
- LÁMPARA HALÓGENA PARA FAROS DE LANTEROS

30132X 12V 55W **30169X** 24V 70W

MASTER 200 INNER 10



LAMPADA H5

30138

(E) Approved **H5**



- LAMPADA ALOGENA PER FARI ANTERIORI
- HALOGEN BULB FOR FRONT LIGHT
- AMPOULE HALOGÈNE POUR PROJECTEURS AVANT
- Halogenlampe für Frontscheinwerfer
- LÁMPARA HALÓGENA PARA FAROS DE LANTEROS

30138 12V 60-55W

MASTER 200 INNER 10



ASIMMETRICA 2 LUCI

30142X



P 45 T

- LAMPADA ASIMMETRICA 2 LUCI
- DIPPERD / MAIN BEAM BULB
- AMPOULE ASIMETRIQUE 2 FEUX
- Asymmetrische 2-Licht-Lampe
- FARO DE LUZ ASIMETRICA 2 LUCES

30142X 12V 45-40W

MASTER 200 INNER 10



LAMPADA 1 FILAMENTO

30144X-30146X



BA 15 S

- 10PZ. LAMPADA A 1 FILAMENTO PER SEGNALATORI
- 10PCS. SINGLE FILAMENT INDICATOR BULBS
- 10 PCS. AMPOULE À 1 FEU SIGNALISATEURS
- 10 stk. 1 Licht-Lampe für blinker
- 10 PZAS LÁMPARA CON 1 LUZ PARA SEÑALADORES

10 PEZZI

30144X 12V 21W **30146X** 24V 21W

MASTER 200 INNER 10



LAMPADE SFERICHE

30151X - 30152X - 30154X



BA 15 S

- 10PZ. LAMPADA SFERICHE PER FANALINI
- 10PCS. ROUND SIDE LIGHT BULBS
- 10 PCS. AMPOULE SPHERIQUE POUR PHARES
- 10 stk. Kugellampe für Rücklichter
- 10 PZAS LÁMPARA ESFERICA PARA FAROS

10 PEZZI

30151X 12V 10W **30152X** 12V 5W **30154X** 24V 5W

MASTER 200 INNER 10



LAMPADA MICRO

30162



- 10PZ. LAMPADE MICRO
 - 10PCS. MICRO BULBS
 - 10 PCS. AMPOULE MICRO
 - 10 stk. mikro lampe
 - 10 PZAS LÁMPARAMICRO
- MASTER 200 INNER 10

BA 9 S 10 PEZZI

30162X	12V 3W
---------------	--------



LAMPADA MICRO

30160X-30192X - 30173X-30189X



- 10PZ. LAMPADE MICRO
 - 10PCS. MICRO BULBS
 - 10 PCS. AMPOULE MICRO
 - 10 stk. mikro lampe
 - 10 PZAS LÁMPARAMICRO
- MASTER 200 INNER 10

BA 9 S 10 PEZZI

30160X	12V 4W	30173X	24V 2W
30189X	24V 4W	30192X	12V 2W



LAMPADE 2 FILAMENTI

30148X-30150X



- 10PZ. LAMPADE A 2 FILAMENTI PER SEGALATORI
 - 10PCS. TWIN FILAMENTS INDICATOR BULBS
 - 10 PCS. AMPOULE À 2 FEUX SIGNALISATEURS
 - 10 stk. 2 Licht-Lampe für Blinker
 - 10 PZAS LÁMPARA CON 2 LUCES PARA SEÑALADO
- MASTER 200 INNER 10

BAY 15 D 10 PEZZI

30148X	12V 5/21W
30150X	24V 5/21W



LAMPADE SILURO

30165X - 30166X - 30174X - 30187X



- 10PZ. LAMPADE SILURO
 - 10PCS. TORPEDO BULBS FOR DASHBOARD LIGHTS
 - 10 PCS. AMPOULE TURPILLE FIXATION POUR TABLEAU DE BORD
 - 10 stk. Torpedulampe Sockel für Armaturenbrettbeleuchtung
 - 10 PZAS LAMPARA CASQUILLO PARA ILUMINACION DEL SALPICADERO
- MASTER 200 INNER 10

10,5 X 38 10 PEZZI

30165X	12V 10W
30166X	12V 5W
30174X	24V 5W
30187X	24V 10W



LAMPADA MICRO

30156X - 30161X



- 10PZ. LAMPADE MICRO TUTTO VETRO
- 10PCS. MICRO BULBS ALL GLASS
- 10 PCS. AMPOULE MICRO TOUT VETRE
- 10 stk. Mikro Lampe ganz aus Glas
- 10 PZAS LÁMPARAMICRO TODO CRISTAL

30156X MASTER 200 INNER 10 **30161X** MASTER 500 INNER 10

T 10 10 PEZZI

30156X	12V 5W
30161X	24V 5W



LAMPADE MIGNON

30147X - 30164X



- 10PZ. LAMPADE MICRO MIGNON PER INDICATORI TUTTO VETRO
- 10PCS. MICRO BULBS FOR INDICATOR ALL GLASS
- 10 PCS. AMPOULE MICRO MIGNON TOUT VETRE
- 10 stk. Mikro Lampe mignon ganz aus Glas
- 10 PZAS LÁMPARAMICRO TODO CRISTAL

MASTER 200 INNER 10

T 5 10 PEZZI

30147X	24V 1,2W
30164X	12V 1,2W



LED DAY PROFESSIONAL LIGHT

77868

- LUCI DI POSIZIONE A LED
- SIDE MARKER LAMP LED
- VOYANTS DE POSITION LED
- LED-Position leuchtet
- LUCES DE POSICIÓN LED

A BASSO CONSUMO ENERGETICO

TUTELA DELL'AMBIENTE

LUMINOSITÀ MODERATA, NON ABBAGLIA, RIDUZIONE DELL'INQUINAMENTO LUMINOSO. UTILIZZO DI MATERIALI RINNOVABILI ECOCOMPATIBILI PER LA PRODUZIONE, PUÒ ESSERE RIUTILIZZATO.

LOW POWER CONSUMPTION

ENVIRONMENTAL PROTECTION

MODERATE BRIGHTNESS, DOES NOT PRODUCE GLARE, REDUCTION OF LIGHT POLLUTION. USING ENVIRONMENTALLY FRIENDLY RENEWABLE MATERIALS TO MANUFACTURE, CAN BE REUSED.



MASTER 20 INNER 10



8 LED x 2 - 12V



TORCIA A LED

77354

- TORCIA A LED CON MAGNETE E GANCIO
- LED FLASHLIGHT WITH MAGNET AND HOOK
- TORCHE PORTABLE À LED
- 27 Led Taschenlampe tragbare
- 27 LED LINTERNA PORTÁTILE



27 LED

GANCIO E MAGNETE - HOOK AND MAGNET

MASTER 144 INNER 12



MULTI-SURFACE REFLECTOR

18559

VETRO BIANCO LUCE GIALLA
WHITE GLASS YELLOW LIGHT

- FARO FENDINEBBIA LENTICOLARE
- PROJECTOR BEAM FOG LAM
- PROJECTEURS A LENTILLE ANTIBROUILLARD
- Linsen Nebelscheinwerfer
- FAROS ANTINEBLA LENTICULAR
- LAMPADE H3 12V 55W
- TECNOLOGIA AVANZATA
- MASSIMA ILLUMINAZIONE
- SENZA SPRECO DI LUCE
- MONTAGGIO UNIVERSALE
- BULB: H3 12V 55W.
- ADVANCED TECHNOLOGY.
- MAXIMUM LIGHTING POWER WITH NO WASTED LIGHT.
- UNIVERSAL MOUNTING.

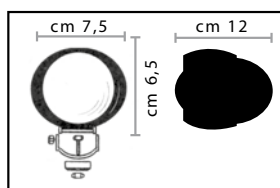

MASTER 6

LAMPADINA MOTO

60080

- LAMPADA ALOGENA H1 12V 55W BLISTER
- HALOGEN LAMP H1 12V 55W BLISTER
- LAMPE HALOGÈNE H1 12V 55W EN BLISTER
- Halogenlampe H1 12V 55W in Luftpolsterfolienverpackung
- LÁMPARA H1 12V 55W BLISTER



+50% DI LUMINOSITÀ

H1 - P14,5S 12V - 55 WATT

LAMPADA ALOGENA ANTERIORE

MASTER 100 INNER 10

ESPOSITORE

30598

L'espositore viene fornito vuoto



ESPOSITORE

30597

L'espositore viene fornito vuoto



ESPOSITORE DA BANCO

30599

L'espositore viene fornito vuoto



LAMPADE

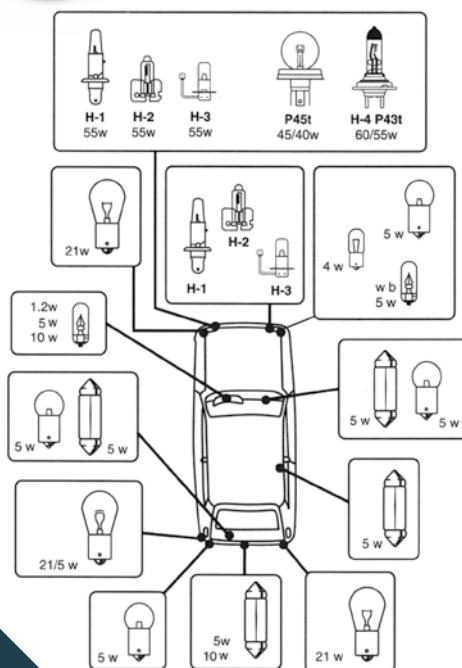

GUIDA APPLICAZIONE LAMPADE



RUOTE WHEELS

SUPPORTO VENDITA ACCESSORI RUOTE





RUOTE

WHEELS

CATENE DA NEVE GOODYEAR	pag 134
CATENE DA NEVE GULF	pag 142
CATENE DA NEVE BOTTARI	pag 144
CALZE DA NEVE BOTTARI	pag 152
CATENE DA NEVE TRUCK BOTTARI	pag 153
COPRICERCHI GOODYEAR	pag 154
COPERTURA PNEUMATICI - PORTAGOMME GOODYEAR	pag 156
COPRICERCHI BOTTARI	pag 158
ACCESSORI RUOTE	pag 164



COPPIA CATENE DA NEVE

da **77950** - a **77958**

- LA CATENA NEVE CON IL PIÙ BASSO PROFILO AL MONDO, PER APPLICAZIONI SU VEICOLI CON INGOMBRI MECCANICI RIDOTTI E PER UN ELEVATO CONFORT
- WORLD LOWEST PROFILE CHAIN FOR LOW CLEARANCE VEHICLES APPLICATION AND FOR MAXIMUM CONFORT
- COUPLE DES ENGINES DE NEIGE
- Paar Schneekaten
- PAREJA DE CATENES DE NIEVE

MANGANESE a maglia ritorta

7mm

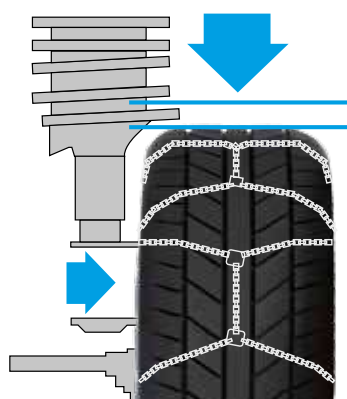

CON TENSIONATORE - WITH TENSIONER

G7

EINSATZBEREICH
PKW
V 5117
N 000279

UNI 11313



GEPRÜFT

77950	MISURA/SIZE 060
77951	MISURA/SIZE 065
77952	MISURA/SIZE 070
77953	MISURA/SIZE 080
77954	MISURA/SIZE 090
77955	MISURA/SIZE 100
77956	MISURA/SIZE 110
77957	MISURA/SIZE 120
77958	MISURA/SIZE 130

Prodotto conforme alla norma di unificazione europea del ministero delle infrastrutture e dei trasporti. Queste catene sono omologate e certificate secondo le norme:

UNI 11313:2010 E ÖNORM

Come certificato dal gs-tüv istituto leader europeo per le certificazioni dei prodotti nel settore dei trasporti



The product conforms to the european unification regulations by the ministry of infrastructures and transport. These chains are authorised and certified in conformity to the following regulations:

UNI 11313:2010 E ÖNORM

As certified by gs-tüv, the leading european institute for certification of products in the transport sector

MASTER 5

Coppia di catene da neve premium 7mm a maglia ritorta

Montaggio rapido con cavo flessibile a tensionamento autobloccante. Acciaio in lega al manganese per una resistenza e durata ancora più elevata, con maglia ritorta da mm 7. Cavo laterale interno ricoperto di pvc colorato e aggancio esterno a vista con tensore autobloccante.

7mm twisted link premium show chains Equipped with flexible cable and self-locking tensor. Longer life and stronger manganese stainless steel, with 7mm twisted link. Internal side cable covered with coloured pvc and sight external coupler with self locking tensor. Ideal for cars with abs. Maximum safety and less vibration.



GOODYEAR 7mm

CODICE	CERCHIO		13	14	15	16	17	18	19	20
	MISURA									
77950	60		165/80-13	165-14	155-15	175/55-16				
			175-13	165/75-14	155/80-15	175/60-16				
			175/75-13	165/80-14	165/65-15	185/50-16				
			175/80-13	175/70-14	165/70-15	195/45-16				
			185/70-13	175/75-14	175/65-15	205/40-16				
			185/75-13	185/65-14	185/55-15					
			195/65-13	195/60-14	195/55-15					
			205/60-13	205/55-14	205/45-15					
				215/45-15						
77951	65			185/70-14	185/60-15	195/50-16				
					195/55-15					
77952	70		185-13	175-14	165-15	185/55-16	205/40-17			
			185/80-13	175/80-14	165/80-15	205/45-16	225/35-17			
			195/70-13	185/75-14	175/70-15	215/40-16				
			205/65-13	195/65-14	185/65-15					
			205/70-13		195/60-15					
					205/50-15					
					205/55-15					
					215/50-15					
				225/45-15						
77953	80			185-14	175-15	185/60-16	205/45-17	205/40-18		
				185/80-14	175/80-15	185/65-16	215/40-17			
				195/70-14	185/70-15	195/55-16	225/40-17			
				205/65-14	205/60-15	205/50-16				
				215/60-14		215/45-16				
77954	90			195-14	185-15	195/60-16	215/45-17	215/40-18		
				195/80-14	185/80-15	205/55-16	205/50-17	225/35-18		
				205/70-14	195/65-15	225/45-16				
				215/65-14	195/70-15	215/50-16				
				225/55-14	205/60-15					
				225/60-14	205/65-15					
					215/60-15					
					225/50-15					
				225/55-15						
77955	100			215/70-14	195/75-15	195/65-16	225/45-17	205/45-18		
				225/70-14	205/65-15	205/60-16	235/40-17	215/45-18		
				235/60-14	205/70-15	215/55-16		235/35-18		
					215/65-15	225/50-16				
					225/60-15					
					235/55-15					
77956	110			245/60-14	215/70-15	195/70-16	205/55-17	215/50-18	235/35-19	
					225/65-15	205/65-16	215/50-17	225/40-18		
					235/60-15	215/60-16	215/55-17	225/45-18		
						225/55-16	225/50-17	235/40-18		
						235/50-16	235/45-17	235/35-18		
						245/45-16	245/40-17			
							255/40-17			
77957	120				225/70-15	215/65-16	215/60-17	215/55-18	225/40-19	
					245/60-15	225/60-16	235/50-17	225/50-18	235/40-19	
					265/50-15	245/50-16	245/45-17	255/35-18		
77958	130				235/70-15	225/65-16	225/55-17	225/55-18	225/45-19	245/35-20
					255/60-15	235/60-16	225/60-17	235/45-18	235/45-19	
					275/50-15	245/55-16	235/55-17	235/50-18	245/35-19	
						255/50-16	255/45-17	245/40-18	245/40-19	
							265/40-17	245/45-18	255/35-19	
							275/40-17	255/40-18	275/30-19	
								255/45-18		
								265/35-18		

COPPIA CATENE DA NEVE

da **77930** - a **77938**

- CATENE DA NEVE AD ELEVATA RESISTENZA PER AUTO, SUV, 4X4, FURGONI E CAMPER MAGLIA CLASSICA CON SEZIONE 12 MM
- EXTRA STRONG SNOW CHAINS FOR CARS, SUV 4X4, LIGHT TRUCKS AND CAMPING VANS 12 MM SIZE CLASSIC LINK
- COUPLE DES ENJINS DE NEIGE
- Paar Schneekaten
- PAREJA DE CATENES DE NIEVE

12mm

SUV
FURGONI
CAMPER
4X4



77930	225
77931	227
77932	230
77933	235
77934	240
77935	245
77936	247
77937	250
77938	255



Z1A 11 04 38856 005

EINSATZBEREICH
 PKW
 V 5117
 N 2004 002



UNI 11313

GEPRÜFT

Prodotto conforme alla norma di unificazione europea del ministero delle infrastrutture e dei trasporti. Queste catene sono omologate e certificate secondo le norme:

UNI 11313:2010 E ÖNORM
 Come certificato dal gs-tüv istituto leader europeo per le certificazioni dei prodotti nel settore dei trasporti



The product conforms to the european unification regulations by the ministry of infrastructures and transport. These chains are authorised and certified in conformity to the following regulations:

UNI 11313:2010 E ÖNORM
 As certified by gs-tüv, the leading european institute for certification of products in the transport sector

MASTER 4



GOODYEAR 12mm

CODICE	CERCHIO		13	14	15	16	16.5	17	17.5	18	19	20
	MISURA											
77930	225			205/75-14 205-14	195/75-15 195x15	185/75-16 195/70-16						
				205/80-14 245/60-14	195/80-15	205/65-16 215/60-16						
					205/75-15 215/65-15							
77931	227				215/70-15	195/75-16 215/60-16						
77932	230	225/55-13	215/75-14	205/80-15	185-16	600-16.5	215/55-17		215/50-18	225/40-19		
			215-14	215/70-15	195/75-16	800-16.5	225/55-17		225/45-18			
			215/80-14	215/75-15	195-16							
			750-14	225/70-15	195/80-16							
				670-15	205/70-16							
				GR78-15	215/65-16							
					215/70-16							
					225/60-16							
					225/65-16							
					600-16							
					640-16							
77933	235				205/75-16		215/60-17		215/55-18			
					215/70-16		225/55-17		245/45-18			
					225/65-16							
					235/60-16							
77934	240			215/75-15	195-16		235/55-17	7-17.5	225/55-18	245/45-19		
				215-15	205/75-16			205/65-17.5	235/50-18	255/40-19		
				215/80-15	205-16				245/45-18			
				225/60-15	205/80-16				255/45-18			
				225/75-15	225/65-16							
				235/70-15	235/60-16							
				255/60-15	650-16							
				700-15	700-16							
				HR78-15								
77935	245			215/80-15	215-16		6.5-17		235/55-18	245/45-19		
				235/70-15	215/75-16		225/60-17		245/50-18			
				235/75-15	215/85-16		225/65-17					
					225/70-16							
					225/75-16							
					235/65-16							
					245/70-16							
77936	247			9-15	235/70-16		75-17	8-17.5	225/60-18			
				30x9.5-15	245/70-16		225/70-17	205/75-17.5	235/50-18			
				215/85-15	255/65-16		235/65-17	215/75-17.5	235/55-18			
				235/75-15	700-16		255/55-17		235/60-18			
				255/70-15								
				265/70-15								
				275/60-15								
				275/80-15								
				295/50-15								
				840-15								
77937	250			750-15	235/80-16	8.75-16.5	235/70-17	8-17.5	235/60-18	235/55-19	235/45-20	
				235/75-15	245/70-16		245/65-17	205/75-17.5	245/60-18		255/40-20	
				255/65-15	245/75-16		255/60-17	215/75-17.5				
				265/70-15	255/65-16		750-17					
					700-16							
					750-16							
77938	255			10-15	185/75-16		245/70-17		235/65-18	255/50-19	235/55-20	
				31x10.5-15	255/70-16		255/60-17		255/55-18	275/45-19	245/50-20	
				255/75-15			255/65-17		255/60-18		255/45-20	
				265/75-15			275/55-17		285/50-18		265/45-20	
											275/40-20	

COPPIA CATENE DA NEVE

da 77900 - a 77916

9mm

- CATENE DA NEVE A ROMBO 9MM. MONTAGGIO RAPIDO CON CAVO FLESSIBILE A TENSIONAMENTO AUTOBLOCCANTE. COSTRUITA CON MAGLIA COMPATTA A SEZIONE "D" DA MM 9. CAVO LATERALE INTERNO RICOPERTO DI PVC COLORATO E AGGANCIAMENTO ESTERNO A VISTA CON TENSORE AUTOBLOCCANTE.
- NET TYPE SNOW CHAINS. EQUIPPED WITH FLEXIBLE CABLE AND SELF-LOCKING TENSOR MANUFACTURED WITH MM 9. COMPACT LINK "D" SHAPE. INTERNAL SIDE CABLE COVERED WITH COLOURED PVC AND SIGHT EXTERNAL COUPLER WITH SELF LOCKING TENSOR. IDEAL FOR CARS WITH ABS. MAXIMUM SAFETY AND LESS VIBRATION.
- COUPLE DES ENGINES DE NEIGE
- Paar Schneekaten
- PAREJA DE CATENES DE NIEVE

MASTER 5



77900	MISURA/SIZE 020
77901	MISURA/SIZE 030
77902	MISURA/SIZE 040
77903	MISURA/SIZE 050
77904	MISURA/SIZE 060
77905	MISURA/SIZE 070
77906	MISURA/SIZE 080
77907	MISURA/SIZE 090
77908	MISURA/SIZE 100
77909	MISURA/SIZE 045
77910	MISURA/SIZE 095
77911	MISURA/SIZE 065
77912	MISURA/SIZE 110
77913	MISURA/SIZE 120
77914	MISURA/SIZE 130
77915	MISURA/SIZE 075
77916	MISURA/SIZE 140

Prodotto conforme alla norma di unificazione europea del ministero delle infrastrutture e dei trasporti. Queste catene sono omologate e certificate secondo le norme:

UNI 11313:2010 E ÖNORM

Come certificato dal gs-tüv istituto leader europeo per le certificazioni dei prodotti nel settore dei trasporti



The product conforms to the european unification regulations by the ministry of infrastructures and transport. These chains are authorised and certified in conformity to the following regulations:

UNI 11313:2010 E ÖNORM

As certified by gs-tüv, the leading european institute for certification of products in the transport sector

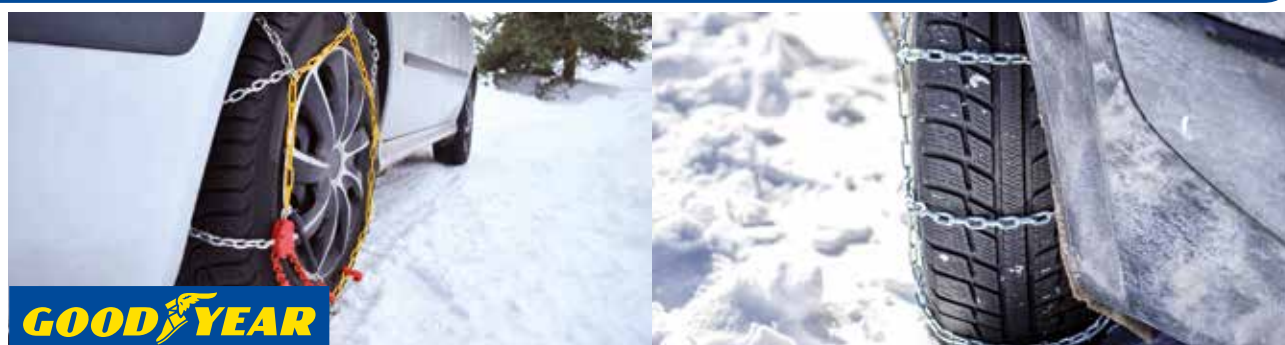



GOODYEAR

CATENE DA NEVE

9mm



GOOD YEAR 9mm

CODICE	CERCHIO		12	13	14	15	16	17	18	19	20	
	MISURA											
77900	20		140-12	125/85-13							150/65-340	
			140/80-12	135-13								150/65-345
			145-12	135/80-13								155/65-340
			145/80-12	145/65-13								160/60-315
			150-12	145/70-13								160/65-315
			150/80-12	155/60-13								
			155/70-12	155/65-13								
			165/60-12	165/55-13								
			500-12	165/60-13								
				170/50-13								
		175/50-13										
77901	30		155-12	140-13	135-14	125-15					180/60-315	
			155/80-12	145-13	135/80-14	135/70-15					170/55-340	
			165/65-12	145/80-13	145/70-14	165/50-15					160/65-340	
			165/70-12	155/70-13	155/60-14							
			560-12	165/65-13	155/65-14							
			600-12	175/60-13	165/55-14							
				185/55-13	165/60-14							
					175/50-14							
77902	40	175/70-12	150/80-13	145-14	135-15						160/65-365	
			155-13	145/80-14	135/80-15						170/55-365	
			155/80-13	155/70-14	145/65-15						170/65-340	
			165/70-13	165/65-14	145/70-15						180/60-340	
			175/65-13	185/50-14	155/60-15						180/65-315	
			185/60-13		165/55-15						185/65-315	
			195/50-13		175/50-15							
			195/55-13									
77909	45			175/60-14	155/65-15							
				185/55-14	175/50-15							
					185/50-15							
77903	50		155/85-13	155-14	145-15						170/65-365	
			160-13	155/80-14	155/70-15						180/65-340	
			165-13	165/70-14	165/60-15						190/55-340	
			165/80-13	175/65-14	165/65-15						190/55-365	
			170-13	185/60-14	170/60-15							
			175/70-13	195/55-14	175/55-15							
			185/65-13	520-14	195/45-15							
			195/60-13	560-14								
			205/50-13									
			560-13									
	590-13											
77904	60		175-13	165-14	155-15	165/55-16					180/65-365	
			175/75-13	165/75-14	165/70-15	175/55-16					190/60-365	
			175/80-13	165/80-14	175/60-15	185/50-16					190/65-340	
			185/70-13	175/70-14	175/65-15	195/45-16					220/50-365	
			195/65-13	185/65-14	185/55-15	205/40-16						
			205/60-13	195/60-14	195/50-15							
	640-13		560-15									
77911	65			175/75-14	185/60-15	175/50-16						
				185/70-14	195/55-15	175/60-16						
				205/55-14	205/50-15	205/45-16						
						215/40-16						
77905	70		185-13	175-14	165-15	195/50-16	205/40-17				180/65-390	
			185/80-13	175/80-14	165/80-15						190/65-365	
			195/70-13	195/65-14	175/70-15						195/60-365	
			205/65-13	205/60-14	185/65-15						200/55-390	
			215/60-13		195/60-15						200/60-365	
			600-13		205/50-15						200/65-340	
											210/55-365	

GOODYEAR 9mm

CODICE	CERCHIO		12	13	14	15	16	17	18	19	20
	MISURA										
77915	75					205/55-15 215/50-15	185/55-16 185/60-16 205/50-16 215/45-16	225/35-17			
77906	80			205/70-13	185-14	185/70-15	185/65-16	205/45-17			190/65-390 200/60-390 210/55-390 220/55-365
77907	90				195-14	180-15	195/65-16	205/50-17	205/40-18		220/55-390
					195/75-14	185-15	205/55-16	215/45-17	225/35-18		
					195/80-14	195/70-15	215/50-16	235/40-17			
					205/70-14	205/65-15	225/45-16				
					215/65-14	215/60-15					
					225/60-14	225/50-15					
					245/40-14	225/55-15					
					600-14						
77910	95					195/75-15	195/70-16	205/55-17	215/40-18		
						205/70-15	205/60-16	215/50-17	215/45-18		
						215/65-15	205/65-16	225/45-17	225/40-18		
						225/60-15	215/55-16	245/40-17	245/35-18		
						235/55-15	215/60-16				
							225/50-16				
77908	100				205-14	195-15	235/50-16	215/50-17	225/45-18	235/35-19	220/65-390 225/40-475 230/55-390 240/45-390 240/45-415 240/55-390
					205/75-14	195/80-15	245/45-16	215/55-17	235/40-18		
					205/80-14	205-15		225/50-17	255/85-18		
					215-14	215/70-15					
					215/70-14	225/65-15					
					215/75-14	230/60-15					
					225/70-14	235/60-15					
					235/60-14	255/45-15					
					245/60-14	600-15					
						890-15					
77912	110					225/65-15	215/60-16	235/45-17	235/40-18		220/65-390 235/40-475
						235/60-15	225/55-16	235/50-17	235/45-18		
							235/55-16				
							245/50-16				
77913	120						215/65-16	215/60-17	215/50-18	225/40-19	
							225/60-16	225/55-17	215/55-18	235/40-19	
							225/65-16	235/50-17	235/45-18	245/35-19	
								245/45-17	245/40-18	255/30-19	
								255/40-17	255/35-18		
								265/40-17			
77914	130					235/70-15	235/60-16	215/65-17	225/50-18	225/45-19	245/35-20 265/30-20
							245/55-16	225/60-17	225/55-18	235/45-19	
								225/65-17	235/50-18	245/40-19	
								235/55-17	245/45-18	255/35-19	
								255/45-17	255/40-18	265/35-19	
								275/40-17	255/45-18	275/30-19	
									275/35-18		
									295/30-18		
77916	140						225/70-16	225/65-17	225/60-18	225/55-19	195/55-20 245/40-20 265/35-20 285/30-20
							235/70-16	235/60-17	235/55-18	245/45-19	
								245/55-17	245/50-18		

COPPIA CATENE DA NEVE

da 76010 - a 76018

- LA CATENA NEVE CON IL PIÙ BASSO PROFILO AL MONDO, PER APPLICAZIONI SU VEICOLI CON INGOMBRI MECCANICI RIDOTTI E PER UN ELEVATO CONFORT
- WORLD LOWEST PROFILE CHAIN FOR LOW CLEARANCE VEHICLES APPLICATION AND FOR MAXIMUM CONFORT
- COUPLE DES ENGINES DE NEIGE
- Paar Schneekaten
- PAREJA DE CATENES DE NIEVE

7mm

CATENA NEVE MANGANESE A MAGLIA RITORTA

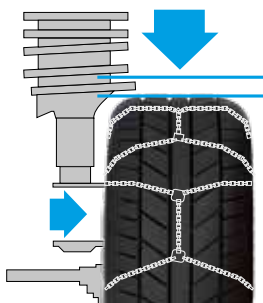

CON TENSIONATORE - WITH TENSIONER

EINSATZBEREICH
 PKW
 V 5117
 N 000279

UNI 11313



GEPRÜFT

Prodotto conforme alla norma di unificazione europea del ministero delle infrastrutture e dei trasporti. Queste catene sono omologate e certificate secondo le norme:

UNI 11313:2010 E ONORM

Come certificato dal gs-tüv istituto leader europeo per le certificazioni dei prodotti nel settore dei trasporti



The product conforms to the european unification regulations by the ministry of infrastructures and transport. These chains are authorised and certified in conformity to the following regulations:

UNI 11313:2010 E ONORM

As certified by gs-tüv, the leading european institute for certification of products in the transport sector

76010	MISURA/SIZE 060
76011	MISURA/SIZE 065
76012	MISURA/SIZE 070
76013	MISURA/SIZE 080
76014	MISURA/SIZE 090
76015	MISURA/SIZE 100
76016	MISURA/SIZE 110
76017	MISURA/SIZE 120
76018	MISURA/SIZE 130

Coppia di catene da neve premium 7mm a maglia ritorta

Montaggio rapido con cavo flessibile a tensionamento autobloccante. Acciaio in lega al manganese per una resistenza e durata ancora più elevata, con maglia ritorta da mm 7. Cavo laterale interno ricoperto di pvc colorato e aggancio esterno a vista con tensore autobloccante.

7mm twisted link premium show chains Equipped with flexible cable and self-locking tensor. Longer life and stronger manganese stainless steel, with 7mm twisted link. Internal side cable covered with coloured pvc and sight external coupler with self locking tensor. Ideal for cars with abs. Maximum safety and less vibration.

MASTER 5



Gulf 7mm

CODICE	CERCHIO		13	14	15	16	17	18	19	20
	MISURA									
76010	60		165/80-13	165-14	155-15	175/55-16				
			175-13	165/75-14	155/80-15	175/60-16				
			175/75-13	165/80-14	165/65-15	185/50-16				
			175/80-13	175/70-14	165/70-15	195/45-16				
			185/70-13	175/75-14	175/65-15	205/40-16				
			185/75-13	185/65-14	185/55-15					
			195/65-13	195/60-14	195/55-15					
			205/60-13	205/55-14	205/45-15					
76011	65			185/70-14	185/60-15	195/50-16				
					195/55-15					
76012	70		185-13	175-14	165-15	185/55-16	205/40-17			
			185/80-13	175/80-14	165/80-15	205/45-16	225/35-17			
			195/70-13	185/75-14	175/70-15	215/40-16				
			205/65-13	195/65-14	185/65-15					
			205/70-13		195/60-15					
					205/50-15					
					205/55-15					
					215/50-15					
76013	80			185-14	175-15	185/60-16	205/45-17	205/40-18		
				185/80-14	175/80-15	185/65-16	215/40-17			
				195/70-14	185/70-15	195/55-16	225/40-17			
				205/65-14	205/60-15	205/50-16				
				215/60-14		215/45-16				
76014	90			195-14	185-15	195/60-16	215/45-17	215/40-18		
				195/80-14	185/80-15	205/55-16	205/50-17	225/35-18		
				205/70-14	195/65-15	225/45-16				
				215/65-14	195/70-15	215/50-16				
				225/55-14	205/60-15					
				225/60-14	205/65-15					
					215/60-15					
					225/50-15					
					225/55-15					
76015	100			215/70-14	195/75-15	195/65-16	225/45-17	205/45-18		
				225/70-14	205/65-15	205/60-16	235/40-17	215/45-18		
				235/60-14	205/70-15	215/55-16		235/35-18		
					215/65-15	225/50-16				
					225/60-15					
76016	110			245/60-14	215/70-15	195/70-16	205/55-17	215/50-18	235/35-19	
					225/65-15	205/65-16	215/50-17	225/40-18		
					235/60-15	215/60-16	215/55-17	225/45-18		
						225/55-16	225/50-17	235/40-18		
						235/50-16	235/45-17	235/35-18		
						245/45-16	245/40-17			
							255/40-17			
76017	120				225/70-15	215/65-16	215/60-17	215/55-18	225/40-19	
					245/60-15	225/60-16	235/50-17	225/50-18	235/40-19	
					265/50-15	245/50-16	245/45-17	255/35-18		
76018	130				235/70-15	225/65-16	225/55-17	225/55-18	225/45-19	245/35-20
					255/60-15	235/60-16	225/60-17	235/45-18	235/45-19	
					275/50-15	245/55-16	235/55-17	235/50-18	245/35-19	
						255/50-16	255/45-17	245/40-18	245/40-19	
							265/40-17	245/45-18	255/35-19	
							275/40-17	255/40-18	275/30-19	
								255/45-18		
						265/35-18				



COPPIA CATENE DA NEVE

da 18812N - a 18835N

9mm

- CATENE DA NEVE A ROMBO 9MM. MONTAGGIO RAPIDO CON CAVO FLESSIBILE A TENSIONAMENTO AUTOBLOCCANTE. COSTRUITA CON MAGLIA COMPATTA A SEZIONE "D" DA MM 9. CAVO LATERALE INTERNO RICOPERTO DI PVC COLORATO E AGGANCIAMENTO ESTERNO A VISTA CON TENSORE AUTOBLOCCANTE.
- NET TYPE SNOW CHAINS. EQUIPPED WITH FLEXIBLE CABLE AND SELF-LOCKING TENSOR MANUFACTURED WITH MM 9. COMPACT LINK "D" SHAPE. INTERNAL SIDE CABLE COVERED WITH COLOURED PVC AND SIGHT EXTERNAL COUPLER WITH SELF LOCKING TENSOR. IDEAL FOR CARS WITH ABS. MAXIMUM SAFETY AND LESS VIBRATION.
- COUPLE DES ENGINES DE NEIGE
- Paar Schneekaten
- PAREJA DE CATENES DE NIEVE



MASTER 5

18812N	020
18813N	030
18814N	040
18815N	050
18816N	060
18817N	070
18818N	080
18819N	090
18820N	100
18821	045
18822N	095
18823	065
18831N	110
18832N	120
18833N	130
18834N	075
18835N	140

RAPID T2

Prodotto conforme alla norma di unificazione europea del ministero delle infrastrutture e dei trasporti. Queste catene sono omologate e certificate secondo le norme:

UNI 11313:2010 E ÖNORM
 Come certificato dal gs-tuv istituto leader europeo per le certificazioni dei prodotti nel settore dei trasporti



The product conforms to the european unification regulations by the ministry of infrastructures and transport. These chains are authorised and certified in conformity to the following regulations:

UNI 11313:2010 E ÖNORM
 As certified by gs-tuv, the leading european institute for certification of products in the transport sector



CON TENSIONATORE - WITH TENSIONER

CATENE DA NEVE

9 mm



Bottari 9mm

CODICE	CERCHIO		12	13	14	15	16	17	18	19	20	
	MISURA											
18812N	20		140-12	125/85-13							150/65-340	
			140/80-12	135-13								150/65-345
			145-12	135/80-13								155/65-340
			145/80-12	145/65-13								160/60-315
			150-12	145/70-13								160/65-315
			150/80-12	155/60-13								
			155/70-12	155/65-13								
			165/60-12	165/55-13								
			500-12	165/60-13								
				170/50-13								
				175/50-13								
18813N	30		155-12	140-13	135-14	125-15					180/60-315	
			155/80-12	145-13	135/80-14	135/70-15					170/55-340	
			165/65-12	145/80-13	145/70-14	165/50-15					160/65-340	
			165/70-12	155/70-13	155/60-14							
			560-12	165/65-13	155/65-14							
			600-12	175/60-13	165/55-14							
				185/55-13	165/60-14							
					175/50-14							
18814N	40	175/70-12	150/80-13	145-14	135-15						160/65-365	
			155-13	145/80-14	135/80-15						170/55-365	
			155/80-13	155/70-14	145/65-15						170/65-340	
			165/70-13	165/65-14	145/70-15						180/60-340	
			175/65-13	185/50-14	155/60-15						180/65-315	
			185/60-13		165/55-15						185/65-315	
			195/50-13		175/50-15							
			195/55-13									
18821	45			175/60-14	155/65-15							
				185/55-14	175/50-15							
					185/50-15							
18815N	50		155/85-13	155-14	145-15						170/65-365	
			160-13	155/80-14	155/70-15						180/65-340	
			165-13	165/70-14	165/60-15						190/55-340	
			165/80-13	175/65-14	165/65-15						190/55-365	
			170-13	185/60-14	170/60-15							
			175/70-13	195/55-14	175/55-15							
			185/65-13	520-14	195/45-15							
			195/60-13	560-14								
			205/50-13									
			560-13									
	590-13											
18816N	60		175-13	165-14	155-15	165/55-16					180/65-365	
			175/75-13	165/75-14	165/70-15	175/55-16					190/60-365	
			175/80-13	165/80-14	175/60-15	185/50-16					190/65-340	
			185/70-13	175/70-14	175/65-15	195/45-16					220/50-365	
			195/65-13	185/65-14	185/55-15	205/40-16						
			205/60-13	195/60-14	195/50-15							
18823	65			175/75-14	185/60-15	175/50-16						
				185/70-14	195/55-15	175/60-16						
				205/55-14	205/50-15	205/45-16						
18817N	70		185-13	175-14	165-15	195/50-16	205/40-17				180/65-390	
			185/80-13	175/80-14	165/80-15						190/65-365	
			195/70-13	195/65-14	175/70-15						195/60-365	
			205/65-13	205/60-14	185/65-15						200/55-390	
			215/60-13		195/60-15						200/60-365	
			600-13		205/50-15						200/65-340	
										210/55-365		

Bottari 9mm

CODICE	CERCHIO MISURA	12	13	14	15	16	17	18	19	20
		18834N	75				205/55-15 215/50-15	185/55-16 185/60-16 205/50-16 215/45-16	225/35-17	
18818N	80		205/70-13	185-14 185/75-14 185/80-14 195/70-14 205/65-14 225/55-14	185/70-15 195/65-15 195/55-16 205/60-15 195/60-16	185/65-16 205/45-17 215/40-17				190/65-390 200/60-390 210/55-390 220/55-365
18819N	90			195-14 195/75-14 195/80-14 205/70-14 215/65-14 225/60-14 245/40-14 600-14	180-15 185-15 195/70-15 195/50-16 205/55-16 215/50-16 225/50-15 225/55-15	195/65-16 205/50-17 215/45-17 225/35-18 235/40-17 225/45-16	205/40-18 225/35-18			220/55-390
18822N	95				195/75-15 205/70-15 215/65-15 225/60-15 235/55-15	195/70-16 205/60-16 205/65-16 215/55-16 215/60-16 225/50-16	205/55-17 215/50-17 225/45-17 245/40-17 215/60-16	215/40-18 225/40-18 245/35-18		
18820N	100			205-14 205/75-14 205/80-14 215-14 215/70-14 215/75-14 225/70-14 235/60-14 245/60-14	195-15 195/80-15 205-15 215/70-15 225/65-15 230/60-15 235/60-15 255/45-15 600-15 890-15	235/50-16 245/45-16 225/50-17 215/50-17 215/55-17 225/50-17 235/60-15 255/45-15	215/50-17 235/40-18 225/50-17 255/85-18	225/45-18 235/35-19	220/65-390 225/40-475 230/55-390 240/45-390 240/45-415 240/55-390	
18831N	110				225/65-15 235/60-15	215/60-16 225/55-16 235/55-16 245/50-16	235/45-17 235/50-17	235/40-18 235/45-18		220/65-390 235/40-475
18832N	120					215/65-16 225/60-16 225/65-16	215/60-17 225/55-17 235/50-17 245/45-17 255/40-17 265/40-17	215/50-18 215/55-18 235/45-18 245/40-18 255/35-18	225/40-19 235/40-19 245/35-19 255/30-19	
18833N	130				235/70-15	235/60-16 245/55-16	215/65-17 225/60-17 225/65-17 235/55-17 255/45-17 275/40-17	225/50-18 225/55-18 235/50-18 245/45-18 255/40-18 255/45-18 275/35-18 295/30-18	225/45-19 235/45-19 245/40-19 255/35-19 265/35-19 275/30-19	245/35-20 265/30-20
18835N	140					225/70-16 235/70-16	225/65-17 235/60-17 245/55-17	225/60-18 235/55-18 245/50-18	225/55-19 245/45-19	195/55-20 245/40-20 265/35-20 285/30-20



COPPIA CATENE DA NEVE

da 67999 - a 68014

- CATENE DA NEVE A ROMBO. MONTAGGIO RAPIDO CON CAVO FLESSIBILE A TENSIONAMENTO AUTOBLOCCANTE. COSTRUITA CON MAGLIA COMPATTA A SEZIONE "D". CAVO LATERALE INTERNO RICOPERTO DI PVC COLORATO E AGGANCI ESTERNO A VISTA CON TENSORE AUTOBLOCCANTE.
- NET TYPE SNOW CHAINS. EQUIPPED WITH FLEXIBLE CABLE AND SELF-LOCKING TENSION. MANUFACTURED WITH COMPACT LINK "D" SHAPE. INTERNAL SIDE CABLE COVERED WITH COLOURED PVC AND SIGHT EXTERNAL COUPLER WITH SELF LOCKING TENSOR.
- COUPLE DES ENGINES DE NEIGE
- Paar Schneekaten
- PAREJA DE CATENES DE NIEVE



MASTER 3

16mm **MASTER T16**

**speciale per furgoni,
 4x4 e fuoristrada**

special for van, 4x4 and off-road



67999	190
68000	200
68001	210
68002	220
68003	225
68004	230
68005	240
68006	245
68007	247
68008	248
68009	250
68010	255
68011	260
68012	265
68013	270
68014	275

UNI 11313



Z1A 13 11 35858 013

Prodotto conforme alla norma di unificazione europea del ministero delle infrastrutture e dei trasporti.

Queste catene sono omologate e certificate secondo le norme:

**UNI 11313:2010
 E ÖNORM**

Come certificato dal gs-tuv istituto leader europeo per le certificazioni dei prodotti nel settore dei trasporti



The product conforms to the european unification regulations by the ministry of infrastructures and transport. These chains are authorised and certified in conformity to the following regulations:

**UNI 11313:2010
 E ÖNORM**

As certified by gs-tuv, the leading european institute for certification of products in the transport sector



1



2



3



4



Bottari **16mm**

CODICE	CERCHIO		13	14	15	16	16.5	17	17.5	18	19	19.5	20
	MISURA												
67999	190			165-14									
				165/75-14									
				185/65-14									
68000	200			175-14									
				650-14									
				175/75-14									
				175/80-14									
				185/70-14									
68001	210			18-14	640-15								
				185-14	175/80-15								
				185/80-14	165-15								
				195/75-14									
				205/65-14									
				215/65-14									
				185/75-14									
				700-14									
				195/70-14									
68002	220			670-14	195/70-15	175/75-16							
				215/70-14	215/65-15	600-16							
				195-14	205/65-15	175-16							
				215/65-14	185-15	175/70-16							
				195/75-14		175/80-16							
				205/70-14		195/65-16							
68003	225			205-14	195/80-15	205/65-16							
				205/75-14	205/75-15	185/75-16							
				245/60-14	195/75-15								
					195-15								
					205/70-15								
					215/65-15								
68004	230	225/55-13	215-14	670-15	225/60-16	600-16.5	225/55-17		225/45-18	225/40-19			
			750-14	215/70-15	225/65-16	800-16.5	215/55-17		215/50-18				
			215/75-14	225/70-15	205/70-16								
			215/80-14	GR78-15	640-16								
				205/80-15	185-16								
				215/75-15	195-16								
					195/75-16								
					640-16								
					600-16								
					195-16								
					215/70-16								
					215/65-16								
					195/80-16								
68005	240			225/60-15	205/75-16		235/55-17	205/65-17.5	245/45-18	245/45-19			
				235/70-15	205-16			7-17.5	225/55-18	255/40-19			
				HR78-15	650-16				235/50-18				
				215/80-15	235/60-16				255/45-18				
				700-15	205/80-16								
				215-15	700-16								
				255/60-15	195-16								
				215/75-15	225/65-16								
				225/75-15									

Bottari 16mm

CODICE	CERCHIO MISURA	13	14	15	16	16.5	17	17.5	18	19	19.5	20
68006	245			235/75-15	215-16		6.5-17		235/55-18	245/45-19		
				235/70-15	215/85-16		225/65-17		245/50-18			
				215/80-15	215/75-16		225/60-17					
					245/70-16		235/60-17					
					225/70-16							
					225/75-16							
68007	247			9-15	255/65-16		75-17	205/75-17.5	235/55-18			
				215/85-15	700-16		235/65-17	8-17.5	225/60-18			
				255/70-15	235/70-16		225/70-17	215/75-17.5	235/60-18			
				275/60-15	245/70-16		255/55-17	205/75-17.5	235/50-18			
				275/80-15								
				295/50-15								
				840-15								
				235/75-15								
				265/70-15								
68008	248			250-15								
				250/70-15								
68009	250			750-15	255/65-16	8.75-16.5	255/60-17	215/75-17.5	235/60-18	235/55-19		235/45-20
				235/75-15	700-16		750-17	205/75-17.5	245/60-18			255/40-20
				265/70-15	750-16		235/70-17	8-17.5				
				255/65-15	235/80-16		245/65-17					
					245/75-16							
68010	255			10-15	255/75-16		255/60-17		255/55-18	275/45-19		275/40-20
				255/75-15	185/75-16		275/55-17		235/65-18	255/50-19		255/45-20
				265/75-15			255/60-17		255/60-18			265/45-20
				31x10.5-15			245/70-17		285/50-18			265/45-20
							255/65-17					245/50-20
68011	260				205/85-16			8.5-17.5			7-19.5	
								225/75-17.5				
68012	265				265/70-16		245/75-17		265/60-18	285/45-19		255/50-20
					265/75-16		265/65-17			255/55-19		
68013	270			8.25-15	8.25-16			9.50-17.5	7.00-18		8.00-19.5	700-20
								235/75-17.5	7.50-18			6.50-20
								245/70-17.5				315-35-20
68014	275										245/70-19.5	
											265/70-19.5	



SNOW SOCKS

68041-68042-68043

- CALZE DA NEVE
- SNOW AND ICE SOCKS
- CHAUSSETTE NEIGE ET VERGLAS
- Schneesocken
- FUNDAS ANTIDESLIZANTES NIEVE Y HIELO

MASTER 20

68041 - SIZE S
68042 - SIZE M
68043 - SIZE L



Calze da neve Bottari

La soluzione ideale e rapida per guidare in sicurezza sulla neve

Snow and Ice socks
The ideal solution, easy and fast on the snow!



ISTRUZIONI

• USO

Se la strada non è coperta di neve (asfalto visibile), si raccomanda di non utilizzare le calze da neve al fine di prevenire eventuali danni. Le calze da neve devono essere montate sulle ruote motrici del veicolo. Dopo l'uso, è necessario asciugare le calze e successivamente riportarle nella confezione. Si raccomanda di lavare a mano le calze dopo l'uso.

• SICUREZZA

Le calze da neve possono modificare la traiettoria del veicolo, soprattutto se il terreno è asciutto. La velocità massima del veicolo non deve superare i 50 km / h. La rottura della calza può causare la perdita di aderenza del veicolo e/o deterioramento di un componente meccanico. Lo stato delle calze dovrebbe essere controllato periodicamente durante l'uso. Il prodotto usurato o danneggiato perde di efficacia. Non guidare mai con calze su strade senza neve o ghiaccio. Brusche frenate e/o forti accelerazioni possono danneggiare il prodotto e la sua efficienza. Arrestare il veicolo in caso di rottura della calza. Le calze devono essere rimosse quando il veicolo è fermo (rischio di gelo o basse temperature).

INSTRUCTIONS

• USE

If the road isn't covered with snow (visible asphalt), it is recommended not to use the socks to prevent damages. The Socks are mounted on the drive wheels of the vehicle. After using the socks, it is necessary to dry them before placing in its packaging. It is recommended to hand wash the socks after use.

• SECURITY

Textile socks change the trajectory of the vehicle, especially if it is dry soil. The vehicle speed must not exceed 50 km/h. Rupture of the textile sock may cause loss of adhesion of the vehicle and/or deterioration of a mechanical component. Their status should be checked periodically during use. Worn or damaged socks are not effective. Never drive with socks on roads without snow or ice. The heavy braking and hard acceleration can damage the textile socks. Stop the vehicle in case of breakage of the sock. The socks must be removed when the vehicle is stationary (risk of frost or low temperatures).

Dimensione pneumatico - Tire size - Dimensions pneus - Dimensiones neumático

Taille	13"	14"	15"	16"	17"	18"	19"	20"
Size S	155/80R13	165/65R14	135/70R15	175/55R16	215/35R17	225/30R18		
	165/80R13	165/70R14	145/65R15	185/50R16	205/40R17			
	175/70R13	165/75R14	155/65R15	195/45R16	215/40R17			
	185/70R13	175/65R14	155/70R15	195/50R16	195/40R17			
	195/65R13	175/70R14	165/60R15	205/40R16	225/35R17			
	195/70R13	185/60R14	165/65R15	205/45R16	245/35R17			
	205/60R13	185/65R14	175/55R15	215/40R16				
	205/65R13	195/55R14	175/60R15	215/45R16				
	215/60R13	195/60R14	185/55R15	225/40R16				
	225/60R13	205/55R14	185/60R15	175/50R16				
Size M	185/65R13	205/60R14	195/50R15	255/35R16				
	145/80R14	205/50R15	205/50R15					
	135/80R14	215/50R15						
	155/70R14	125/80R15						
	145/70R14	145/70R15						
	155/80R14	215/45R15						
	135/80R15	235/45R15						
	205/70R13	165/80R14	145/80R15	165/65R16	175/55R17	205/40R18	255/30R19	
	175/60R13	175/75R14	155/80R15	175/60R16	195/45R17	215/35R18		
	185/60R13	175/80R14	165/70R15	185/55R16	205/45R17	215/40R18		
Size L	235/60R13	185/70R14	175/65R15	185/60R16	205/50R17	225/35R18		
		185/75R14	175/70R15	195/55R16	215/45R17	255/35R18		
		185/80R14	185/65R15	205/50R16	225/40R17	235/35R18		
		195/70R14	195/60R15	205/55R16	225/45R17	255/30R18		
		205/65R14	195/65R15	215/50R16	235/40R17	245/35R18		
		215/60R14	200/60R15	225/45R16	245/40R17	225/40R18		
		215/65R14	205/55R15	225/50R16	255/40R17			
		225/60R14	205/60R15	245/45R16				
		235/60R14	215/55R15					
			225/50R15					
		225/55R15						
		245/50R15						
		255/45R15						
	195/75R14	165/80R15	165/75R16	185/60R17	205/45R18	225/35R19	245/30R20	
	205/70R14	175/75R15	175/70R16	185/65R17	205/55R18	225/40R19	245/35R20	
	205/75R14	175/80R15	175/75R16	205/55R17	215/45R18	225/45R19	255/35R20	
	215/70R14	185/70R15	175/80R16	215/50R17	215/50R18	235/35R19		
	215/75R14	185/75R15	185/65R16	225/45R17	225/45R18	235/35R19		
	185/80R14	195/70R15	185/75R16	225/50R17	225/50R18	245/35R19		
	195/80R14	195/75R15	195/60R16	225/55R17	235/40R18	245/40R19		
	245/60R14	205/65R15	195/65R16	235/45R17	235/45R18	255/30R19		
	225/70R14	205/70R15	205/60R16	235/50R17	245/40R18	255/35R19		
	205/80R14	215/60R15	205/65R16	245/45R17	245/45R18	255/40R19		
	235/70R14	215/65R15	215/55R16	245/50R17	255/45R18	265/30R19		
		225/60R15	215/60R16	255/45R17	255/45R18	265/35R19		
		225/65R15	225/55R16	265/40R17	265/40R18			
		230/65R15	225/60R16					
		235/55R15	235/50R16					
		235/60R15	235/55R16					
		245/60R15	245/50R16					
		245/65R15	245/55R16					

TRUCK-TOP

68029-68030-68040

- CATENE NEVE PER VEICOLI INDUSTRIALI. BATTISTRADA CON DISEGNO A ROMBO IN ACCIAIO SPECIALE ZINCATO
- SNOW CHAINS FOR HEAVY DUTY TRUCKS "DIAMOND" SHAPE CHAIN STAINLESS STEEL ANTIWEAR TREATMENT, ZINC GALVANIZING
- CHAÎNES EIGE POUR VÉHICULES INDUSTRIELS. BANDE DE ROULEMENT AVEC DESSIN À RHOMBE EN ACIER SPÉCIAL ZINGUÉ
- Schneeketten fuer Nutzfahrzeug. Profil mit Rhombus-Zeichnen, aus spezial verzinkter Stahl
- CADENAS DE NIEVE PARA VEHÍCULOS INDUSTRIALES. MÓDELO TIPO ROMBO, FABRICADA EN ACERO GALVANIZADO



Catene truck e camion

UNI 11313:2010

EINSATZBEREICH
 PKW
 V 5117



Prodotto conforme alla norma di unificazione europea del ministero delle infrastrutture e dei trasporti. Queste catene sono omologate e certificate secondo le norme: **UNI 11313:2010 E ÖNORM**
 Come certificato dal gs-tüv istituto leader europeo per le certificazioni dei prodotti nel settore dei trasporti.
 The product conforms to the european unification regulations by the ministry of infrastructures and transport. These chains are authorised and certified in conformity to the following regulations: **UNI 11313:2010 E ÖNORM**
 As certified by gs-tüv, the leading european institute for certification of products in the transport sector.



1

2

CODICE		15	16	17.5	19.5	20	22	22.5	24	24.5
68029	260		750-16	8,5-17,5	7-19,5					
			235/85-16	225/75-17,5						
68030	310					1000-20		11-22,5		
						12,4-20		D22,5 Pilote		
						12/80-20		275/80-22,5		
						D20 Pilote		305/70-22,5		
								315/70-22,5		
68040	520					14,5-20		15-22,5	320/70-24	
						14,9-20		385/65-22,5		
						14/18-20				
						F20 Pilote				
						365/80-20				
						375/75-20				

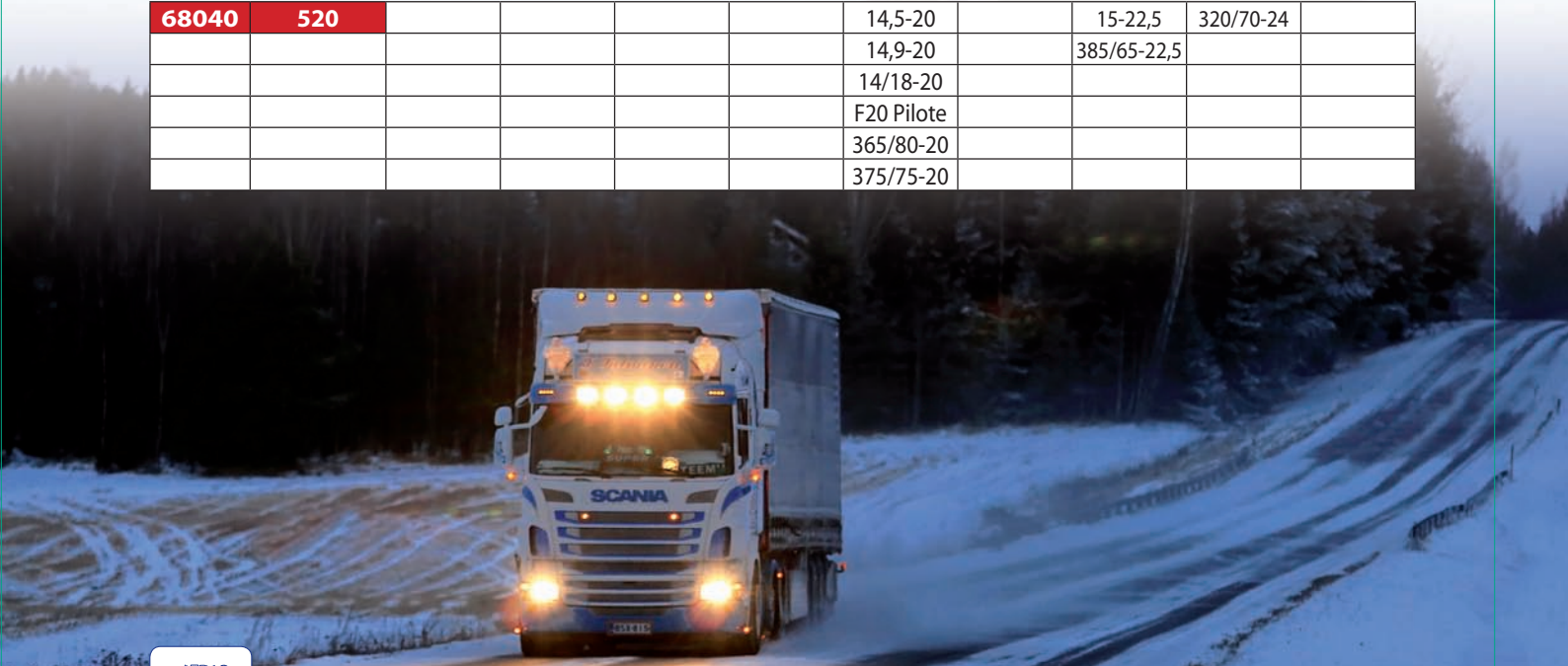

TOURER BICOLOR



77270-77271

- SERIE COPRICERCHI 4 PZ
- SET OF 4 PCS. WHEEL COVERS
- JEU DE 4 ENJOLIVEURS
- Satz mit 4 Raddeckeln
- JUEGO TAPACUBOS 4 PZ

NEW

BICOLOR

MASTER 4

77270 - 14"

77271 - 15"



TOURER



77272-77273

- SERIE COPRICERCHI 4 PZ
- SET OF 4 PCS. WHEEL COVERS
- JEU DE 4 ENJOLIVEURS
- Satz mit 4 Raddeckeln
- JUEGO TAPACUBOS 4 PZ

NEW

MASTER 4

77272 - 14"

77273 - 15"



La nuova serie di copricerchi Goodyear, offre un aspetto speciale ai veicoli, grazie alla superficie esterna coperta con vernice lucida ne conferisce un ottimo aspetto. Il fissaggio a pressione non causa graffi al cerchione. Sono dotati di aperture per valvole. Montaggio senza attrezzi



TOURER GT

77274-77275

- SERIE COPRICERCHI 4 PZ
- SET OF 4 PCS. WHEEL COVERS
- JEU DE 4 ENJOLIVEURS
- Satz mit 4 Raddeckeln
- JUEGO TAPACUBOS 4 PZ

BICOLOR

MASTER 4

77274 - 14"

77275 - 15"

GOODYEAR

NEW



SET 4 PEZZI COPRICERCHI
FISSAGGIO A PRESSIONE
SET OF 4 PCS. WHEEL COVER
PRESS ON ASSEMBLY

4^{pz}

GOODYEAR

SERIE COPRICERCHI

Set of wheel covers

Press on assembly

**FISSAGGIO
A PRESSIONE**

PROTECTOR

77385

- COPERTURA SINGOLA PER 4 PNEUMATICI
- SINGLE TYRE COVER FOR 4 TYRES
- PROTECTION INDIVIDUELLE POUR 4 PNEUS
- Einzeln für 4 Reifen
- CUBIERTA INDIVIDUAL PARA 4 NEUMÁTICOS

MASTER 72

77385

argento

silver



Salva i pneumatici impilati da sporco e intemperie, in estate e in inverno
 Chiusura con corda
Misura: 120 cm x 80 cm diametro

It saves stacked tyres from dirt and bad weather, in summer and winter season
 With a string for tightening
Size: 120 cm height x 80 cm diameter



STRUTTURA PER CERCHI E PNEUMATICI

77250

- STRUTTURA PER CERCHI E PNEUMATICI
- WHEEL AND TYRE TREE
- ARBRE À JANTES ET À PNEUS
- Felgen-und Reifenbaum
- ÁRBOL PARA LLANTA Y NEUMÁTICO

MASTER 5

77250

nero

black



x4
 ruote - wheels

Pratica e robusta struttura in acciaio per stivare in poco spazio 4 ruote da auto complete con diametro da 13 a 17 pollici, adatta anche per pneumatici senza cerchi. Di facile montaggio. Per migliorare la stabilità si consiglia di posizionare i cerchi con il lato esterno verso l'interno della struttura. Qualora si appendano alla struttura pneumatici non montati sui cerchi, si consiglia di interporre un panno/spessore morbido tra gancio e pneumatico, per evitare deformazioni allo stesso.

Practical and robust steel structure to hold in little space 4 full wheels with diameter from 13 to 17 inches, suitable also for tires only. Easy to assemble. To improve stability, it is advisable to place the rims with the outside on the inside of the structure. If you hang tires not mounted on the rims, it is advisable to interpose a soft cloth between the hook and the tire to prevent deformation.



PORTAGOMME DA MURO

77249

- PORTAGOMME DA MURO
- WALL TYRES RACK
- HARNAIS DE MUR
- Wall Harness
- ARNÉS DE PARED

Larghezza regolabile da 90cm a 125cm - Per 4 pneumatici di larghezza sino a "305" ciascuno. Portata massima 90Kg - Facile installazione a muro. Realizzato con robusto e durevole acciaio verniciato a polvere - Richiudibile e salvaspazio

Adjustable width from 90cm to 125cm - Suitable for 4 tyres up to "305" wide each - Max. Load 90Kg. Easy wall installation - Made of strong and durable powder coated steel - Easy to clouse, space saver

Gomme fino a 22" - Tyres up to 22"

90kg
MAX

x4
ruote - wheels



NEW YORK

18491-18492-18493

- SERIE COPRICERCHI 4 PZ
- SET OF 4 PCS. WHEEL COVERS
- JEU DE 4 ENJOLIVEURS
- Satz mit 4 Raddeckeln
- JUEGO TAPACUBOS 4 PZ

MASTER 4

18491 - 13"

18492 - 14"

18493 - 15"



MENORCA

18479-18480

- SERIE COPRICERCHI 4 PZ
- SET OF 4 PCS. WHEEL COVERS
- JEU DE 4 ENJOLIVEURS
- Satz mit 4 Raddeckeln
- JUEGO TAPACUBOS 4 PZ

MASTER 4

18479 - 14"

18480 - 15"



DALLAS

18687-18688-18689

- SERIE COPRICERCHI 4 PZ
- SET OF 4 PCS. WHEEL COVERS
- JEU DE 4 ENJOLIVEURS
- Satz mit 4 Raddeckeln
- JUEGO TAPACUBOS 4 PZ

MASTER 4

18687 - 14"

18688 - 15"

18689 - 16"



IBIZA

18481-18482

- SERIE COPRICERCHI 4 PZ
- SET OF 4 PCS. WHEEL COVERS
- JEU DE 4 ENJOLIVEURS
- Satz mit 4 Raddeckeln
- JUEGO TAPACUBOS 4 PZ

MASTER 4

18481 - 14"

18482 - 15"



CHICAGO

18690-18691-18692-18693

- SERIE COPRICERCHI 4 PZ
- SET OF 4 PCS. WHEEL COVERS
- JEU DE 4 ENJOLIVEURS
- Satz mit 4 Raddeckeln
- JUEGO TAPACUBOS 4 PZ

MASTER 4

18690 - 13"

18691 - 14"

18692 - 15"

18693 - 16"



VALENCIA

18483-18484

- SERIE COPRICERCHI 4 PZ
- SET OF 4 PCS. WHEEL COVERS
- JEU DE 4 ENJOLIVEURS
- Satz mit 4 Raddeckeln
- JUEGO TAPACUBOS 4 PZ

MASTER 4

18483 - 14"

18484 - 15"



PORTO

18684-18685

- SERIE COPRICERCHI 4 PZ
- SET OF 4 PCS. WHEEL COVERS
- JEU DE 4 ENJOLIVEURS
- Satz mit 4 Raddeckeln
- JUEGO TAPACUBOS 4 PZ

MASTER 4

18684 - 14"

18685 - 15"



MALLORCA

18678-18679-18686

- SERIE COPRICERCHI 4 PZ
- SET OF 4 PCS. WHEEL COVERS
- JEU DE 4 ENJOLIVEURS
- Satz mit 4 Raddeckeln
- JUEGO TAPACUBOS 4 PZ

MASTER 4

18678 - 13"

18679 - 14"

18686 - 15"



LOTUS BICOLOR

18187-18188

- SERIE COPRICERCHI 4 PZ
- SET OF 4 PCS. WHEEL COVERS
- JEU DE 4 ENJOLIVEURS
- Satz mit 4 Raddeckeln
- JUEGO TAPACUBOS 4 PZ

MASTER 4

18187 - 13"

18188 - 14"



SUZUKA

18164-18165

- SERIE COPRICERCHI 4 PZ
- SET OF 4 PCS. WHEEL COVERS
- JEU DE 4 ENJOLIVEURS
- Satz mit 4 Raddeckeln
- JUEGO TAPACUBOS 4 PZ

MASTER 4

18164 - 14"

18165 - 15"



NEW

SUZUKA BLACK

18166-18167

- SERIE COPRICERCHI 4 PZ
- SET OF 4 PCS. WHEEL COVERS
- JEU DE 4 ENJOLIVEURS
- Satz mit 4 Raddeckeln
- JUEGO TAPACUBOS 4 PZ

MASTER 4

18166 - 14"

18167 - 15"



NEW

SUZUKA BICOLOR

18168-18169

- SERIE COPRICERCHI 4 PZ
- SET OF 4 PCS. WHEEL COVERS
- JEU DE 4 ENJOLIVEURS
- Satz mit 4 Raddeckeln
- JUEGO TAPACUBOS 4 PZ

MASTER 4

18168 - 14"

18169 - 15"



NEW

SILVERSTONE

18450-18451

- SERIE COPRICERCHI 4 PZ
- SET OF 4 PCS. WHEEL COVERS
- JEU DE 4 ENJOLIVEURS
- Satz mit 4 Raddeckeln
- JUEGO TAPACUBOS 4 PZ

NEW

MASTER 4

18450 - 14"

18451 - 15"



SILVERSTONE BLACK

18452-18453

- SERIE COPRICERCHI 4 PZ
- SET OF 4 PCS. WHEEL COVERS
- JEU DE 4 ENJOLIVEURS
- Satz mit 4 Raddeckeln
- JUEGO TAPACUBOS 4 PZ

NEW

MASTER 4

18452 - 14"

18453 - 15"



SERIE COPRICERCHI

Set of 4pcs wheel covers

4^{pz}



14"

15"

ALASKA

18421-18422-18423-18424

- COPRICERCHI 1 PEZZO
- 1 PIECE WHEEL COVERS
- 1 ENJOLIVEURS
- 1 Radabdeckung
- TAPACUBOS 1 PC

MASTER 16

18421 - 13"

18422 - 14"

18423 - 15"

18424 - 16"



ALABAMA

18445-18446-18447-18448

- COPRICERCHI 1 PEZZO
- 1 PIECE WHEEL COVERS
- 1 ENJOLIVEURS
- 1 Radabdeckung
- TAPACUBOS 1 PC

MASTER 16

18445 - 13"

18446 - 14"

18447 - 15"

18448 - 16"



CALCUTTA

18442-18443-18444

- COPRICERCHI 1 PEZZO
- 1 PIECE WHEEL COVERS
- 1 ENJOLIVEURS
- 1 Radabdeckung
- TAPACUBOS 1 PC

MASTER 16

18442 - 13"

18443 - 14"

18444 - 15"



COLORADO

18469-18470-18471-18440

- COPRICERCHI 1 PEZZO
- 1 PIECE WHEEL COVERS
- 1 ENJOLIVEURS
- 1 Radabdeckung
- TAPACUBOS 1 PC

MASTER 16

18469 - 13"

18470 - 14"

18471 - 15"

18440 - 16"



DUBAI

18142-18143-18144-18441

- COPRICERCHI 1 PEZZO
- 1 PIECE WHEEL COVERS
- 1 ENJOLIVEURS
- 1 Radabdeckung
- TAPACUBOS 1 PC

MASTER 16

18142 - 13"

18143 - 14"

18144 - 15"

18441 - 16"



NEVADA

18097-18098-18099-18130

- COPRICERCHI 1 PEZZO
- 1 PIECE WHEEL COVERS
- 1 ENJOLIVEURS
- 1 Radabdeckung
- TAPACUBOS 1 PC

MASTER 16

18097 - 13"

18098 - 14"

18099 - 15"

18130 - 16"



ESEMPIO PACK



AIR CUP

15099A-15100A-15101A 15102A-15102BLACK A

- KIT 4 PZ. COPRIVALVOLE IN ALLUMINIO
- 4 PCS. TYRE VALVE CUPS
- KIT 4 PCS. BOUCHONS DE VALVES ALUMINIUM
- 4 Stück alu Vintile Kappen
- JUEGO 4 PZAS. TAPONES VALVULAS NEUMATICO

MASTER 96 - INNER 24

15099A		dark gray
15100A		dark blue
15101A		red
15102A		chrome silver
15102BLACK A		black



AIR CUP

15099B-15100B-15101B 15102B-15102BLACK B

- KIT 4 PZ. COPRIVALVOLE IN ALLUMINIO
- 4 PCS. TYRE VALVE CUPS
- KIT 4 PCS. BOUCHONS DE VALVES ALUMINIUM
- 4 Stück alu Vintile Kappen
- JUEGO 4 PZAS. TAPONES VALVULAS NEUMATICO

MASTER 96 - INNER 24

15099B		dark gray
15100B		dark blue
15101B		red
15102B		chrome silver
15102BLACK B		black



TIRE CUP

27515A-27516A-27517A 27518A-27519A

- KIT 4 PZ. COPRIVALVOLE IN ALLUMINIO
- 4 PCS. TYRE VALVE CUPS
- KIT 4 PCS. BOUCHONS DE VALVES ALUMINIUM
- 4 Stück alu Vintile Kappen
- JUEGO 4 PZAS. TAPONES VALVULAS NEUMATICO

MASTER 96 - INNER 24

27515A		chrome silver
27516A		dark blue
27517A		red
27518A		black
27519A		dark grey



TIRE CUP

27515B-27516B-27517B 27518B-27519B

- KIT 4 PZ. COPRIVALVOLE IN ALLUMINIO
- 4 PCS. TYRE VALVE CUPS
- KIT 4 PCS. BOUCHONS DE VALVES ALUMINIUM
- 4 Stück alu Vintile Kappen
- JUEGO 4 PZAS. TAPONES VALVULAS NEUMATICO

MASTER 96 - INNER 24

27515B		chrome silver
27516B		dark blue
27517B		red
27518B		black
27519B		dark grey



COPRIRUOTA 4X4

18411-18412-18413

- COPRIRUOTA DI SCORTA ELASTICIZZATO
- ELASTICIZED SPARE WHEEL COVER
- PROTEGE-ROUE DE SECOURS ELASTIQUE
- Bedruckte Ersatzreifenabdeckung
Reissfestes Elastisches Material
- CUBRE-RUEDA DE RECAMBIO ELÁSTICO

MASTER 24

18411	Ø74x23cm	no logo
18412	Ø79x28cm	no logo
18413	Ø70x23cm	no logo



IMPERMEABILE
WATERPROOF

PENNARELLO

18546

- PENNARELLO PER PNEUMATICI
- FELT PEN FOR TYRES
- FEUTRE POUR PNEUS
- Filzstift für Reifen
- ROTULADOR PARA NEUMATICOS

MASTER 360 - INNER 12

18546	bianco	white
--------------	--------	-------



MASTER

24150

- CAVARUOTE ESTENSIBILE
- EXTENDABLE WHEEL NUT WRENCH
- TIRE-ROUES ALLONGEABLE
- Verlängerbarer Radlöser
- EQUIPO EXTENSIBLE PARA CAMBIAR LA RUEDA

MASTER 24

24150	Ø 17-19 mm
--------------	------------



MATERIALE GARANTITO
CHROME VANADIUM
GUARANTEED MATERIAL

MASTER

24153

- CAVARUOTE ESTENSIBILE
- EXTENDABLE WHEEL NUT WRENCH
- TIRE-ROUES ALLONGEABLE
- Verlängerbarer Radlöser
- EQUIPO EXTENSIBLE PARA CAMBIAR LA RUEDA

MASTER 24

24153	Ø 17-19-21-23 mm
--------------	------------------



MATERIALE GARANTITO
CHROME VANADIUM
GUARANTEED MATERIAL

SILVER

24161

- CHIAVE A CROCE ARGENTATA
- SILVER FINISH CROSS KEY
- CLEF CRUCIFORME ARGENTÉE
- Versilberter Kreuz-Steckschüssel
- LLAVE DE RUEDA EN CRUZ

MASTER 24

24161	Ø 17-19-21-23 mm
--------------	------------------



PNEUS

18547

- MISURA PRESSIONE PNEUMATICI DIGITALE
- DIGITAL WHEEL PRESSURE MEASURING MACHINE
- MESURE DE LA PRESSION DIGITALE DES PNEUS
- Digitale Druckmessung der Reifen
- MEDIDA PRESIÓN NEUMÁTICOS DIGITAL

MASTER 50 - INNER 10

DOTATO DI LUCE NOTTURNA
DISPLAY BAR LUMINOSO
IN BACHELITE
3 PILE AL LITHIUM INCLUSE
WITH NIGHT LIGHT
LUMINOUS DISPLAY BAR
IN BAKELITE
3 LITHIUM BATTERIES
INCLUDED



PROFESSIONAL

18550

- MISURA PRESSIONE PNEUMATICI
- WHEEL PRESSURE MEASURING MACHINE
- MESURE DE LA PRESSION DES PNEUS
- Druckmessung der Reifen
- MEDIDA PRESIÓN NEUMÁTICOS

MASTER 144 - INNER 24



Misuratori pressione pneumatici

Art.18547

Schermo illuminato display per agevolare la visibilità in condizioni di scarsa illuminazione o di notte. Display digitale con retroilluminazione blu. Lettura esatta, immediata e chiara.

Art.18550

Manometro meccanico dotato di un pulsante di rilascio dell'aria integrato per una misurazione precisa della pressione dei pneumatici.

Funzione di blocco della pressione: blocca la pressione quando la si legge sul manometro, anche quando la valvola del pneumatico viene rimossa. Non funziona a batterie, per cui funzionerà sempre e in tutte le condizioni meteorologiche.

Questo misuratore è robusto, preciso e dotato di rivestimento in gomma. Semplice da usare: con un quadrante di oltre 5 cm di diametro e un raccordo girevole a 360 gradi che permettono di visualizzare chiaramente la pressione delle gomme da qualsiasi angolazione. Perfetto per le valvole di pneumatici in posizioni difficili da raggiungere.

Art.18553

Dotato di un pulsante di sfiato integrato per una precisa regolazione della pressione.

Misuratore di robusta costruzione in acciaio con tubo di gomma rinforzato e giunture interne in ottone più lunghe per prevenire perdite d'aria.

Facile da usare con viti intercambiabili dritte e a 90 gradi sui mandrini, permettendo di effettuare una misurazione da qualsiasi angolazione. Ideale per qualsiasi auto o moto. Affidabile manometro meccanico, funziona perfettamente in tutte le condizioni atmosferiche, senza mai deludere.

KIT MISURA PRESSIONE

18553

- MISURA PRESSIONE PNEUMATICI + PISTOLA ARIA
- TYRE PRESSURE MEASURING KIT + AIR PISTOL
- KIT DE MESURE PRESSION PNEUS + PISTOLET À AIR
- Reifendruckmes-Sungatz + Luftpistole
- MANÓMETRO PRESIÓN NEUMÁTICOS + PISTOLA DE AIRE



max 15Bar



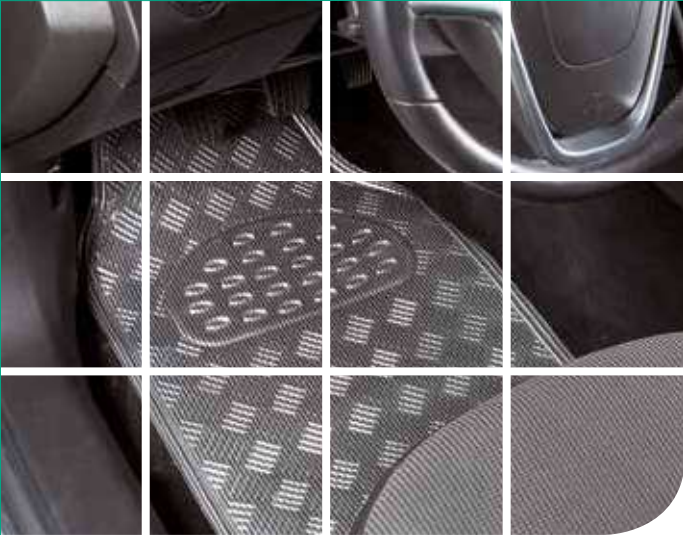

TAPPETI CAR MATS

SUPPORTO VENDITA TAPPETI PER AUTO



www.Bottari.it
Bottari
ITALY



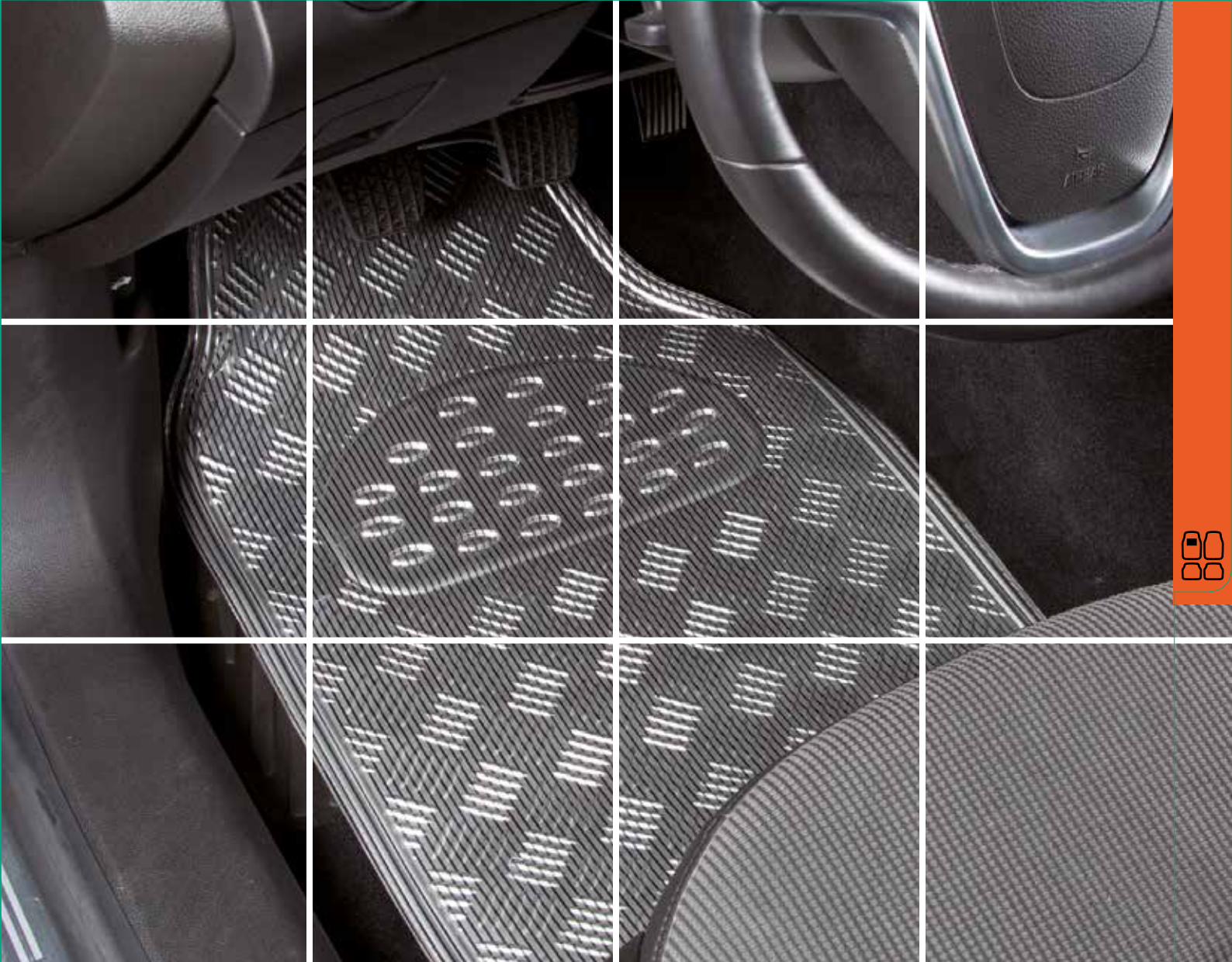

TAPPETI

CAR MATS

TAPPETI SU MISURA IN MOQUETTE	pag 170
TAPPETI SU MISURA IN GOMMA	pag 171
TAPPETI IN GOMMA E MOQUETTE GOODYEAR	pag 174
TAPPETI IN MOQUETTE E GOMMA BOTTARI	pag 177
TAPPETI IN GOMMA E PVC	pag 184
TAPPETI IN GOMMA E BATTITACCO IN MOQUETTE	pag 185
TAPPETI IN GOMMA E LAMINATI	pag 186
ESPOSITORE TOTEM TAPPETI	pag 188



TAPPETI SU MISURA IN MOQUETTE **RICAMO** E BOTTONI DOVE PREVISTI **ANTISCIVOLO**

CUSTOM FIT TEXTILE MATS

TAPPETI SU MISURA PER TUTTE LE AUTO
IN MOQUETTE DI PRIMA SCELTA PER USO
AUTOMOTIVE

100% POLIPROPILENE

FONDO ANTISCIVOLO

ORLATURA RINFORZATA

LUNGA DURATA E PERFETTA ADATTIBILITA'

CON BOTTONI DI FISSAGGIO

(SE PREVISTI IN ORIGINE)

E BATTITACCO IN GOMMA

MASTER 6



Particolare del ricamo

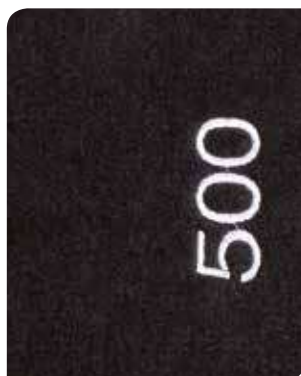

Battitacco in gomma



Bottone di fissaggio



Retro tappeto antiscivolo



TAPPETI SU MISURA IN GOMMA

PROFUMATI ALLA VANIGLIA

VANILLA SCENTED

CUSTOM FIT RUBBER MATS

TAPPETI SPECIFICI SU MISURA PER AUTO
IN GOMMA DI PRIMA SCELTA
CON AMPI RINFORZI E RIQUADRI,
PER GARANTIRE MASSIMA FUNZIONALITA'
E DURATA. BORDI ANTIGOCCIA
E TRATTIENI SPORCO
CON BOTTONI DI FISSAGGIO
(SE PREVISTI IN ORIGINE)
ANTISCIVOLO CERTIFICATI TUV

Safety
Regular
Production
Surveillance

www.tuv.com
ID 000004291



MASTER 6



Particolare della trama



Bottone di fissaggio



Retro tappeto antiscivolo



Logo Bottari



TAPPETI SU MISURA IN MOQUETTE

MARCA BRAND	MODELLO MODEL	COD. MOQUETTE TEXTILE
ALFA ROMEO	MITO	39020
ALFA ROMEO	GIULIETTA	39021
ALFA ROMEO	159	39022
AUDI	A1	39023
AUDI	A3 0309	39024
AUDI	A3 12..	39025
AUDI	A4 0715	39026
AUDI	Q5	39027
AUDI	Q3	39028
BMW	1 0411	39029
BMW	1 12..	39030
BMW	3 0512	39031
BMW	3 12..	39032
BMW	X1 0915	39033
BMW	X3 10..	39034
CITROËN	C1 14..	39035
CITROËN	C3 09..	39036
DACIA	DUSTER 10..	39037
FIAT	PANDA 0311	39038
FIAT	PANDA 12..	39039
FIAT	500 07..	39040
FIAT	500X 14..	39041
FIAT	500L 12..	39042
FIAT	PUNTO 0512	39043
FIAT	BRAVO 0714	39044
FIAT	FREEMONT	39045
FORD	KA 08..	39046
FORD	FIESTA 08..	39047
FORD	FOCUS 10..	39048
HYUNDAI	i10 13..	39049
HYUNDAI	ix35 0915	39050
JEEP	RENEGADE	39051
KIA	PICANTO 11..	39052
KIA	SPORTAGE 1015	39053
LANCIA	Y 11..	39054
LANDROVER	EVOQUE	39055
MERCEDES	A 0412	39056
MERCEDES	A 12..	39057
MERCEDES	B 11..	39058
MERCEDES	C 15..	39059
MERCEDES	GLA	39060
MERCEDES	GLK	39061
MINI	MINI 0114	39062
MINI	COUNTRYMAN	39063
MITSUBISHI	ASX 10..	39064
MITSUBISHI	OUTLANDER	39065

MARCA BRAND	MODELLO MODEL	COD. MOQUETTE TEXTILE
NISSAN	JUKE	39066
NISSAN	MICRA 10..	39067
NISSAN	QASHQAI 0713	39068
NISSAN	QASHQAI 13..	39069
OPEL	AGILA 08..	39070
OPEL	CORSA 06..	39071
OPEL	ASTRA 0915	39072
OPEL	ASTRA 15..	39073
OPEL	MOKKA	39074
OPEL	INSIGNA	39075
OPEL	ZAFIRA 12..	39076
PEUGEOT	107	39077
PEUGEOT	108	39078
PEUGEOT	207	39079
PEUGEOT	208	39080
PEUGEOT	308 13..	39081
RENAULT	TWINGO 0714	39082
RENAULT	TWINGO 14..	39083
RENAULT	CLIO 12..	39084
RENAULT	CAPTUR	39085
RENAULT	KADJAR	39086
RENAULT	SCENIC 0915	39087
SEAT	IBIZA 08..	39088
SEAT	LEON 13..	39089
SKODA	OCTAVIA 12..	39090
SKODA	ROOMSTER	39091
SKODA	YETI	39092
SMART	SMART 0714	39093
SMART	SMART 14..	39094
SUZUKI	JIMNY	39095
SUZUKI	GRAND VITARA 3P	39096
SUZUKI	GRAND VITARA 5P	39097
TOYOTA	AYGO 14..	39098
TOYOTA	YARIS 11..	39099
TOYOTA	RAV4 0512	39100
VOLKSWAGEN	GOLF 0813	39101
VOLKSWAGEN	GOLF 13..	39102
VOLKSWAGEN	POLO 09..	39103
VOLKSWAGEN	TIGUAN 0915	39104
VOLKSWAGEN	TOURAN 1015	39105
VOLKSWAGEN	UP	39106
VOLVO	V 50 0412	39107
VOLVO	V60 11..	39108
VOLVO	XC 60	39109
VOLVO	XC 90 0215	39110

Sono disponibili su ordinazione i tappeti per tutti i modelli di vetture sul mercato e possibilità anche di personalizzazione (solo sui tappeti in moquette).

TAPPETI SU MISURA IN GOMMA

MARCA BRAND	MODELLO MODEL	COD. GOMMA RUBBER
ALFA ROMEO	MITO	39620
ALFA ROMEO	GIULIETTA (FIAT STILO 0208) (FIAT BRAVO 0714) (LANCIA DELTA 0814)	39621
AUDI	A4 0715	39626
AUDI	Q5	39627
AUDI	Q3	39628
BMW	1 0411 (1 COUPÈ 0714) (1 CABRIO 0814) (X1 0915) (1 12..)	39629
BMW	3 0512	39631
BMW	3 11..	39632
BMW	X3 10.. (X4 14.)	39634
CITROËN	C3 09..	39636
DACIA	DUSTER 10.. (LOGAN 08..) (SANDERO 0812)	39637
FIAT	PANDA 0312 (PANDA 12..) (FORD KA 08..) (FIAT 500/C)	39638
FIAT	500X 14.. (JEEP RENEGADE 14..)	39641
FIAT	500L 12..	39642
FIAT	G.PUNTO 05	39643
FIAT	FREEMONT	39645
FORD	FIESTA 08..	39648
FORD	FOCUS 10..	39649
HYUNDAI	TUCSON 15.. (KIA SPORTAGE 15..)	39651
HYUNDAI	ix35 0915 (KIA SPORTAGE 1015)	39652
LANCIA	Y 11..	39656
LANDROVER	EVOQUE	39657
MERCEDES	A 12.. (CLA 13..) (GLA 13..) (B 11..)	39659
MERCEDES	C 0715	39661
MERCEDES	C 15..	39662
MERCEDES	GLK	39664
MINI	MINI 0114	39665
NISSAN	JUKE	39669
NISSAN	QASHQAI 0713	39671
NISSAN	QASHQAI 13..	39672
OPEL	CORSA 06.. (ADAM)	39674
OPEL	ASTRA 0915 (CHEV. ORLANDO) (CHEV. CRUZE)	39675

MARCA BRAND	MODELLO MODEL	COD. GOMMA RUBBER
OPEL	ASTRA 15..	39676
OPEL	MOKKA (CHEV TRAX)	39677
OPEL	INSIGNA	39678
OPEL	ZAFIRA 12..	39679
PEUGEOT	208 (2008)	39683
RENAULT	CLIO 12..	39687
RENAULT	CAPTUR	39688
RENAULT	KADJAR	39689
RENAULT	SCENIC 0915 (SCENIC GRANDTOUR)	39690
SEAT	IBIZA 08.. (SKODA FABIA 14..)	39691
SKODA	OCTAVIA 12...	39693
SMART	SMART 0714	39696
SMART	SMART 14..	39697
SUZUKI	VITARA 14...	39699
TOYOTA	YARIS 11..	39701
TOYOTA	RAV4 0512	39702
TOYOTA	RAV4 13.	39622
VOLKSWAGEN	GOLF VI 0813 (SKODA YETI) (SEAT TOLEDO 0409) (SKODA OCTAVIA 0412) (GOLF V 0308) (SEAT LEON 0512) (JETTA 0510) (SCIROCCO 07)	39703
VOLKSWAGEN	GOLF VII 12. (A3 12..) (SEAT LEON 13..)	39704
VOLKSWAGEN	POLO 09..	39705
VOLKSWAGEN	TIGUAN 0715	39706
VOLKSWAGEN	TOURAN 0315	39707
VOLVO	V 50 0412 (S 40 0412) (C30 0612)	39709
VOLVO	V60 11.. (S80 0615) (V70 1115) (XC700615)	39710
VOLVO	XC 60	39711
VOLVO	XC 90 0215	39712



CON SISTEMA DI FISSAGGIO WITH FIXATION SYSTEM	RESISTENTI ALLE ABRASIONI ABRASIVE RESISTANT	PROFUMATI ALLA VANIGLIA VANILLA SCENTED	RESISTENTI AGLI ACIDI E PRODOTTI CHIMICI NEUTRAL TO CHEMICALLY ACTIVE SUBSTANCES	RESISTENTI AI RAGGI UV UV STABLE	RETRO ANTISCIVOLO ANTI-SLIP UNDERSIDE	ECOLOGICI E RECICLABILI ENVIRONMENTAL FRIENDLY AND RECYCLABLE

TAPPETI SU MISURA IN GOMMA

SET TAPPETI

77136

- SET TAPPETI GOMMA UNIVERSALI SAGOMABILI
- SET OF RUBBER MATS UNIVERSAL SIZE TO SHAPE

- JEU DE 4 PIÈCES TAPIS EN CAOUTCHOUC
- 4 stk. Universele Automatten
- JUEGO DE 4 PIEZAS ALFOMBRAS DE GOMA



4 PCS

SAGOMABILE

MASTER 6

GOODYEAR

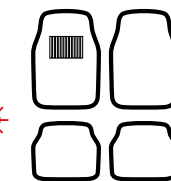
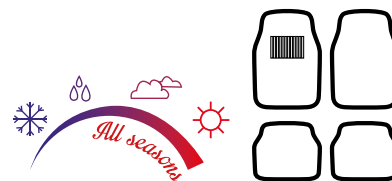

TAPPETI ANTERIORI 49x72 cm
TAPPETI POSTERIORI 44x49 cm

SET TAPPETI

77135

- SET TAPPETI GOMMA UNIVERSALI SAGOMABILI
- SET OF RUBBER MATS UNIVERSAL SIZE TO SHAPE

- JEU DE 4 PIÈCES TAPIS EN CAOUTCHOUC
- 4 stk. Universele Automatten
- JUEGO DE 4 PIEZAS ALFOMBRAS DE GOMA



4 PCS

SAGOMABILE

MASTER 6

GOODYEAR

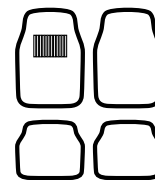
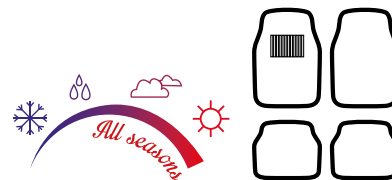

TAPPETI ANTERIORI 49x72 cm
TAPPETI POSTERIORI 33x49 cm

SET TAPPETI

77130

- SET 4 TAPPETI IN MOQUETTE
- 4 PCS SET OF UNIVERSAL MOQUETTE MATS
- JEU DE 4 PIÈCES TAPIS
- 4 STK. Universele Automatten
- JUEGO DE 4 PIEZAS ALFOMBRAS

GOODYEAR

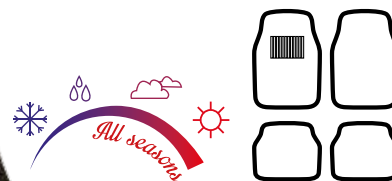

4 PCS

MASTER 12

TAPPETI ANTERIORI 43x64 cm
TAPPETI POSTERIORI 29x41 cm

COPPIA TAPPETI ANTERIORI

77098-77099

- SET TAPPETI GOMMA ANTERIORI UNIVERSALI SAGOMABILI
- SET OF UNIVERSAL SIZE FRONT RUBBER MATS TO SHAPE
- JEU DE 2 PIÈCES TAPIS EN CAOUTCHOUC
- 2 stk. Universele Automatten
- JUEGO DE 2 PIEZAS ALFOMBRAS DE GOMA

GOODYEAR



2 PCS

SAGOMABILE

MASTER 4

TAPPETI ANTERIORI 49x82 cm

TAPPETO GOMMA

77112 - 77113

- TAPPETO SINGOLO GOMMA UNIV. SAGOMABILE
- RUBBER MAT UNIVERSAL SIZE TO SHAPE

- JEU DE 1 PIÈCE TAPI EN CAOUTCHOUC
- 1 Stk. Universele Automatten
- JUEGO DE 1 PIEZA ALFOMBRA DE GOMA

77112	nero	black	
77113	grigio	grey	

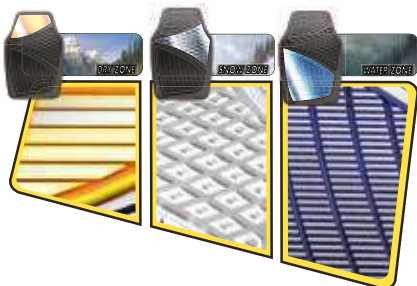

1 PC

SAGOMABILE

MASTER 4



GOODYEAR



TAPPETO ANTERIORE 47x76 cm

TAPPETO GOMMA

77115 - 77116

- TAPPETO SINGOLO GOMMA UNIV. SAGOMABILE
- RUBBER MAT UNIVERSAL SIZE TO SHAPE

- JEU DE 1 PIÈCE TAPI EN CAOUTCHOUC
- 1 Stk. Universele Automatten
- JUEGO DE 1 PIEZA ALFOMBRA DE GOMA

77115	nero	black	
77116	grigio	grey	



1 PC

SAGOMABILE

MASTER 4



GOODYEAR

PROTEZIONE COMPLETA PER OGNI STAGIONE
GOMMA PESANTE E RESISTENTE
BORDO PROTETTIVO IN RILIEVO
DESIGN ADATTABILE
TAPPETO IN MATERIALE ANTI-SLITTAMENTO
COMPLETE PROTECTION FOR ANY WEATHER
HEAVY DUTY RUBBER
RAISED PROTECTIVE BORDER
TRIM-TO-FIT DESIGN
ANTI SKID NIB BACKING



TAPPETO ANTERIORE 48x78 cm

SOFT

14080-14081

- SET 4 TAPPETI IN MOQUETTE
- SET 4 PCS. CAR MATS
- JEU DE 4 PIÈCES TAPIS
- 4 stk. Universele Automatten
- JUEGO DE 4 PIEZAS ALFOMBRAS

14080	nero	
14081	grigio	

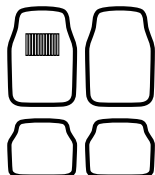

4 PCS

MASTER 6

TAPPETI ANTERIORI 42x64,5 cm
TAPPETI POSTERIORI 29x42 cm

EASY

14082

- SET 4 TAPPETI IN MOQUETTE
- SET 4 PCS. CAR MATS
- JEU DE 4 PIÈCES TAPIS
- 4 stk. Universele Automatten
- JUEGO DE 4 PIEZAS ALFOMBRAS

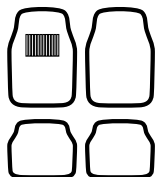

4 PCS

MASTER 12

TAPPETI ANTERIORI 38,5x56,5 cm
TAPPETI POSTERIORI 25x38,5 cm

WAVE

14120-14121-14122-14123-14124-14125

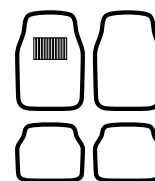

- SET 4 TAPPETI IN MOQUETTE
- SET 4 PCS. CAR MATS
- JEU DE 4 PIÈCES TAPIS
- 4 stk. Universele Automatten
- JUEGO DE 4 PIEZAS ALFOMBRAS

14120	NERO/BLACK	
14121	GRIGIO/GREY	
14122	BLU/BLEU	
14123	ROSSO/RED	
14124	BEIGE	
14125	ROSA/PINK	



UNIVERSALE - LAVABILE
BORDO RICAMATO
ANTISCIVOLO - ANTI - SLIP

4 PCS

TAPPETI ANTERIORI 42x64,5 cm
TAPPETI POSTERIORI 29x42 cm

MASTER 6

GOROS LINE

14043

- SET TAPPETI GOMMA UNIVERSALI SAGOMABILI
- SET OF RUBBER MATS UNIVERSAL SIZE TO SHAPE

- JEU DE 4 PIÈCES TAPIS EN CAOUTCHOUC
- 4 stk. Universele Automatten
- JUEGO DE 4 PIEZAS ALFOMBRAS DE GOMA

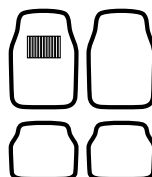

4 PCS

SAGOMABILE

MASTER 6

TAPPETI ANTERIORI 49x72 cm
TAPPETI POSTERIORI 33x49 cm

GOROS LINE

14008

- TAPPETI IN GOMMA UNIVERSALI SAGOMABILI
- RUBBER MATS UNIVERSAL SIZE TO SHAPE

- JEU DE TAPIS EN CAOUTCHOUC
- Universele Automatten
- JUEGO ALFOMBRAS DE GOMA



2 PCS

SAGOMABILE

MASTER 8

TAPPETI ANTERIORI 49x72 cm



BROOKLYN

14058

- SET TAPPETI GOMMA UNIVERSALI SAGOMABILI
- SET OF RUBBER MATS UNIVERSAL SIZE TO SHAPE

- JEU DE 4 PIÈCES TAPIS EN CAOUTCHOUC
- 4 stk. Universele Automatten
- JUEGO DE 4 PIEZAS ALFOMBRAS DE GOMA

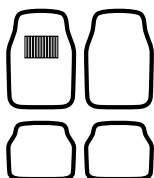

4 PCS

SAGOMABILE

MASTER 12

TAPPETI ANTERIORI 44x60 cm
TAPPETI POSTERIORI 32x44 cm

PERFECT

14035-14036-14037-14038

- TAPPETI IN GOMMA UNIVERSALI SAGOMABILI
- RUBBER MATS UNIVERSAL SIZE TO SHAPE

- JEU DE TAPIS EN CAOUTCHOUC
- Universele Automatten
- JUEGO ALFOMBRAS DE GOMA

14035	ROSSO/RED	
14036	BLU/BLUE	
14037	GRIGIO/GREY	
14038	NERO/BLACK	

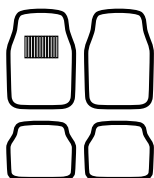

4 PCS

SAGOMABILE

MASTER 6

TAPPETI ANTERIORI 51x70 cm
TAPPETI POSTERIORI 35x51 cm

RADIAL

14041

- SET TAPPETI GOMMA UNIVERSALI SAGOMABILI
- SET OF RUBBER MATS UNIVERSAL SIZE TO SHAPE

- JEU DE 4 PIÈCES TAPIS EN CAOUTCHOUC
- 4 stk. Universele Automatten
- JUEGO DE 4 PIEZAS ALFOMBRAS DE GOMA

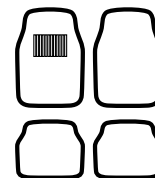

4 PCS

SAGOMABILE

MASTER 6

TAPPETI ANTERIORI 50x70 cm
TAPPETI POSTERIORI 35x50 cm

BIG

14029N

- TAPPETI IN GOMMA UNIVERSALI
- SET OF RUBBER MATS UNIVERSAL

- JEU DE 4 PIÈCES TAPIS EN CAOUTCHOUC
- 4 Stk. Universele Automatten
- JUEGO DE 4 PIEZAS ALFOMBRAS DE GOMA

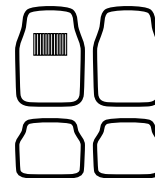

4 PCS

EXTRA-PESANTE

MASTER 4

TAPPETI ANTERIORI 48x72 cm
TAPPETI POSTERIORI 44x48 cm

BINGO

14042N

- SET TAPPETI GOMMA UNIVERSALI SAGOMABILI
- SET OF RUBBER MATS UNIVERSAL SIZE TO SHAPE

- JEU DE 4 PIÈCES TAPIS EN CAOUTCHOUC
- 4 stk. Universele Automatten
- JUEGO DE 4 PIEZAS ALFOMBRAS DE GOMA

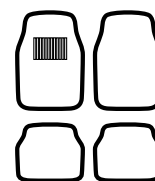

4 PCS

SAGOMABILE

MASTER 6

TAPPETI ANTERIORI 45x70 cm
TAPPETI POSTERIORI 39x45 cm

SCORPION

14023N

- TAPPETI IN GOMMA UNIVERSALI SAGOMABILI
- RUBBER MATS UNIVERSAL SIZE TO SHAPE

- JEU DE TAPIS EN CAOUTCHOUC
- Universele Automatten
- JUEGO ALFOMBRAS DE GOMA

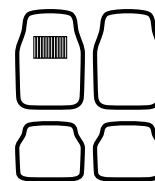

4 PCS

SAGOMABILE

MASTER 6

TAPPETI ANTERIORI 47x70 cm
TAPPETI POSTERIORI 33x40 cm

NEW GHEPARD

14010

- SET TAPPETI GOMMA UNIVERSALI SAGOMABILI
- SET OF RUBBER MATS UNIVERSAL SIZE TO SHAPE

- JEU DE 4 PIÈCES TAPIS EN CAOUTCHOUC
- 4 stk. Universele Automatten
- JUEGO DE 4 PIEZAS ALFOMBRAS DE GOMA

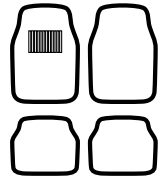

4 PCS

SAGOMABILE

MASTER 6

TAPPETI ANTERIORI 44x65 cm
TAPPETI POSTERIORI 36x44 cm



TAPPETO ANTERIORE

77140

- TAPPETO IN GOMMA
- RUBBER MAT
- TAPIS EN CAOUTCHOUC
- Fussmatten aus Gummi
- ALFOMBRA DE GOMA

LATO GUIDA



72x49cm



1 PC

MASTER 12

SAGOMABILE

SPECIAL

14102

- TAPPETO IN GOMMA DOUBLE-FACE
- DOUBLE-FACE RUBBER MAT
- TAPIS EN CAOUTCHOUC DOUBLE-FACE
- Fussmatten aus Gummi, beidseitig verwendbar
- ALFOMBRA DE GOMA DOBLE-CARA



63x44cm



1 PC

MASTER 20



DOUBLE-FACE

GRIPPER

14114

- TAPPETO IN PVC
- PVC MAT
- TAPIS EN PVC
- Fussmatten aus PVC
- ALFOMBRA DE PVC



47x35cm



1 PC

MASTER 20



PVC

GOMMAX NEW

14115

- TAPPETO IN GOMMA
- RUBBER MAT
- TAPIS EN CAOUTCHOUC
- Fussmatten aus Gummi
- ALFOMBRA DE GOMA



47x35cm



1 PC

MASTER 20



GOMMA100%

SNOW MAT

14108N

- TAPPETO VASCHETTA IN GOMMA
- RUBBER MAT
- TAPIS EN CAOUTCHOUC
- Fussmatten aus Gummi
- ALFOMBRA DE GOMA



1 PC

MASTER 10



56x46cm



CON BORDI RIALZATI

GOMMAX

14103N

- TAPPETO IN GOMMA
- DOUBLE-FACE RUBBER MAT
- TAPIS EN CAOUTCHOUC
- Fussmatten aus Gummi
- ALFOMBRA DE GOMA



1 PC

MASTER 10



48x37cm



SUPER MORBIDO

ZERBINOTTO

14395

- BATTITACCO IN MOQUETTE
- MOQUETTE HEEL-STAMP
- PROTÈGE-TALON EN MOQUETTE
- Absatzschutz aus teppichboden
- ALFOMBRA MOQUETA RECTANGULAR



1 PC



MASTER 24



47x30cm



ZERBINOTTO COMPACT

14398

- BATTITACCO IN MOQUETTE
- MOQUETTE HEEL-STAMP
- PROTÈGE-TALON EN MOQUETTE
- Absatzschutz aus teppichboden
- ALFOMBRA MOQUETA RECTANGULAR



1 PC

MASTER 24



38,5x25cm



HARLEM

14118

- TAPPETO IN GOMMA
- RUBBER MAT
- TAPIS EN CAOUTCHOUC
- Gummi-Fußmatten
- ALFOMBA DE GOMA



1 PC

MASTER 30



52x35cm

UTILE ANCHE IN CASA/GARAGE/TEMPO LIBERO

G4

14109-14110

TAPPETI ANTERIORI 45x67 cm
TAPPETI POSTERIORI 39x45,5 cm

- SET 4 TAPPETI IN GOMMA CON FONDO SPECIALE ANTISCIVOLO + LAMINATO IN PVC
- SET 4 PCS. UNIVERSAL PVC RUBBER CAR MATS WITH SPECIAL NONSLIP RUBBER ON THE BACK + PVC LAMINATED
- JEU DE 4 PIÈCES TAPIS EN PVC AVEC FOND SPECIAL ANTIGLISSEMENT DESSOUS
- 4 STK. Universele Automatten
- JUEGO DE 4 PIEZAS ALFOMBRAS DE PVC CON BASE ESPECIAL ANTIDESLIZANTE

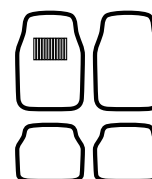

14109	canna di fucile	gun metal
14110	nero	black



14110



14109



4 PCS

MASTER 6

CHROME

17144-17145

- SET 4 TAPPETI IN GOMMA CON FONDO SPECIALE ANTISCIVOLO + LAMINATO IN PVC
- SET 4 PCS. UNIVERSAL PVC RUBBER CAR MATS WITH SPECIAL NONSLIP RUBBER ON THE BACK + PVC LAMINATED
- JEU DE 4 PIÈCES TAPIS EN PVC AVEC FOND SPECIAL ANTIGLISSEMENT DESSOUS
- 4 STK. Universele Automatten
- JUEGO DE 4 PIEZAS ALFOMBRAS DE PVC CON BASE ESPECIAL ANTIDESLIZANTE

17144	blu	blue
17145	nero	black



4 PCS

MASTER 6

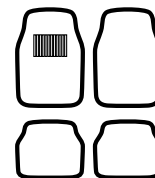
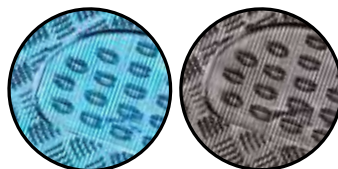

TAPPETI ANTERIORI 45x67 cm
TAPPETI POSTERIORI 39x45,5 cm

NO SLIP

14099

- CLIP FERMA TAPPETI
- CAR MATS CLIPS
- CLIPS POUR TAPIS DE VOITURE
- Automattenklemmen
- CLIPS PARA ALFOMBRILLAS DE COCHE



EVITANO LO SLITTAMENTO DEI TAPPETI
MAGGIOR SICUREZZA
NO SLIPPERY CAR MATS MORE SAFETY

MASTER 144 INNER 72

ESPOSITORE TOTEM

39990

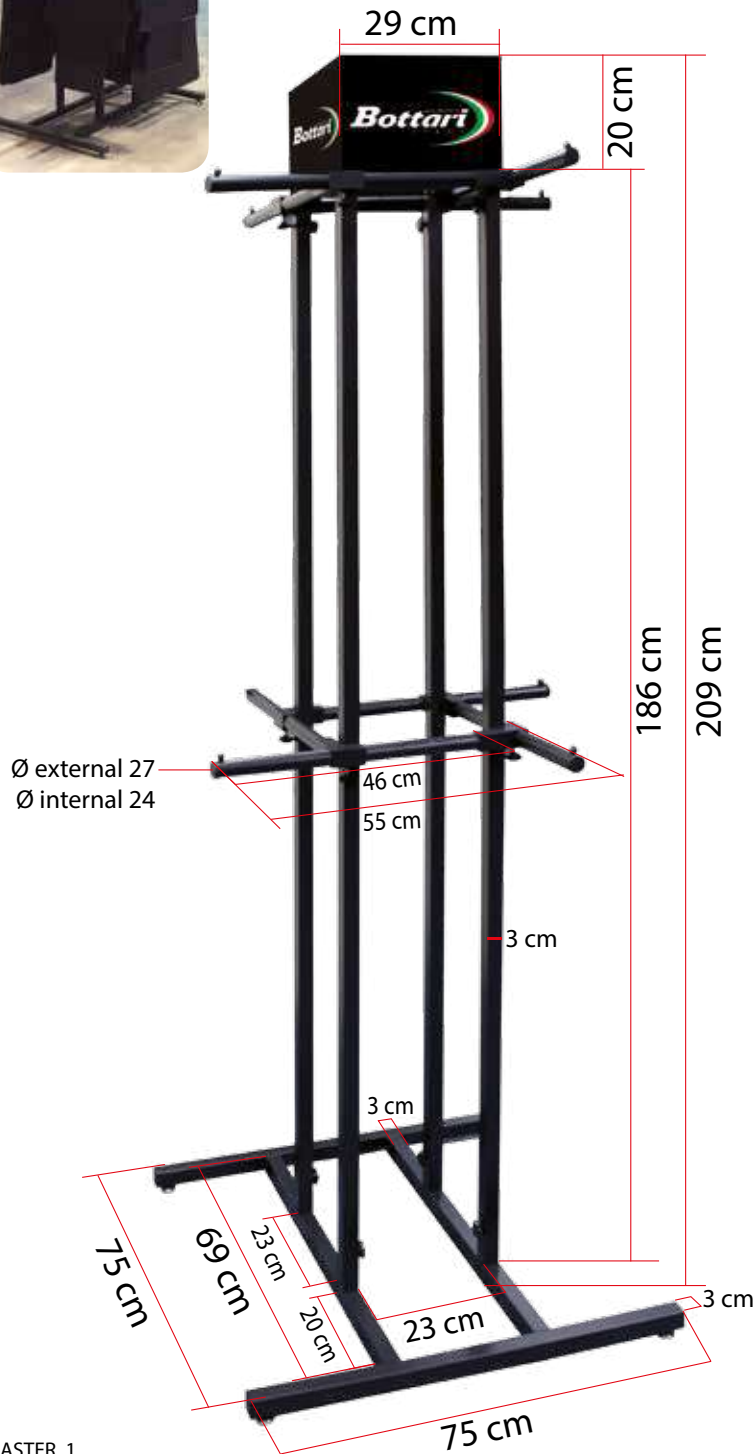

MASTER 1





FODERE E COPRISEDILI

SEAT COVER SEAT CUSHIONS

SUPPORTO VENDITA ACCESSORI
FODERE E COPRISEDILI

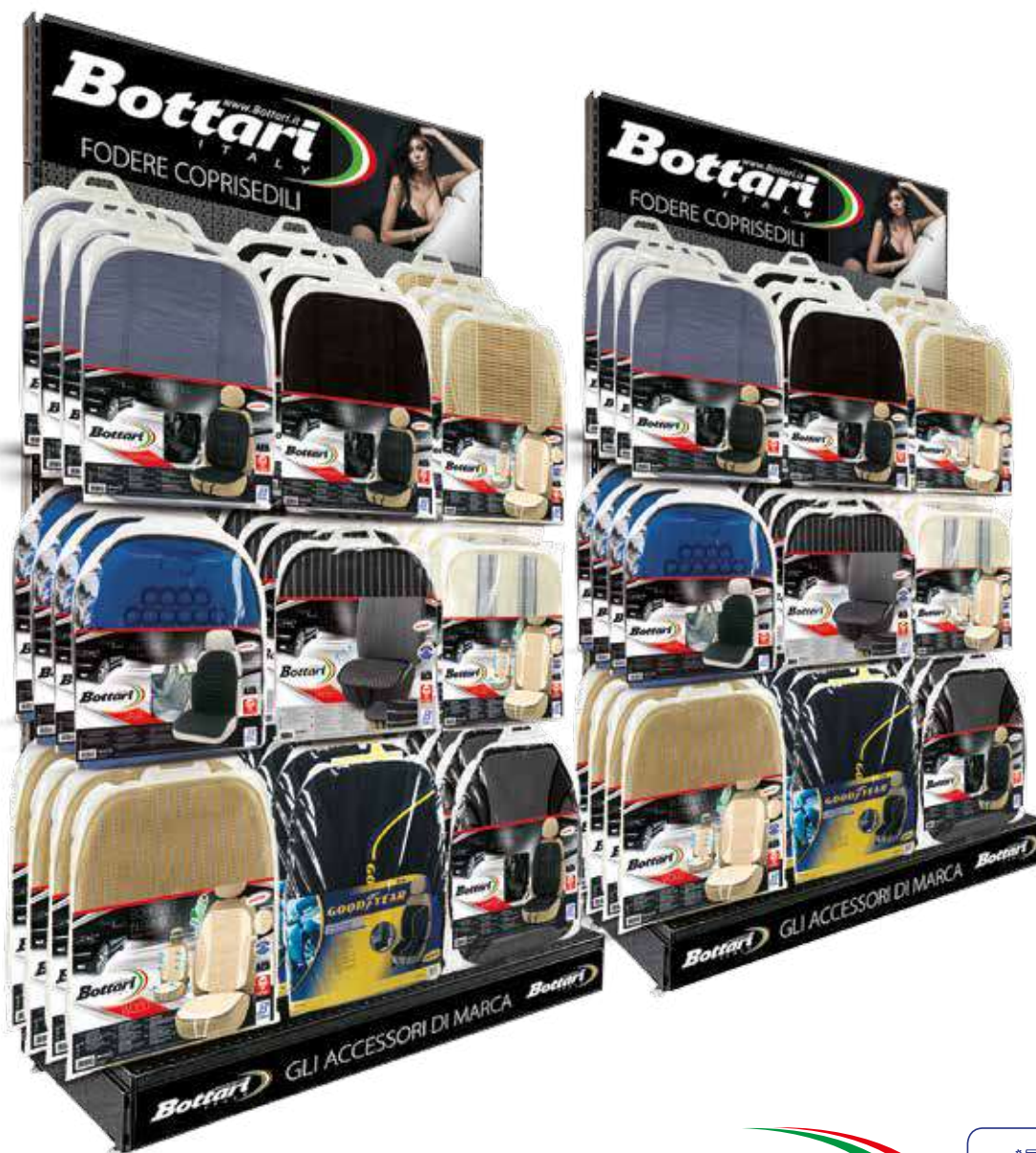

Bottari
www.Bottari.it
ITALY



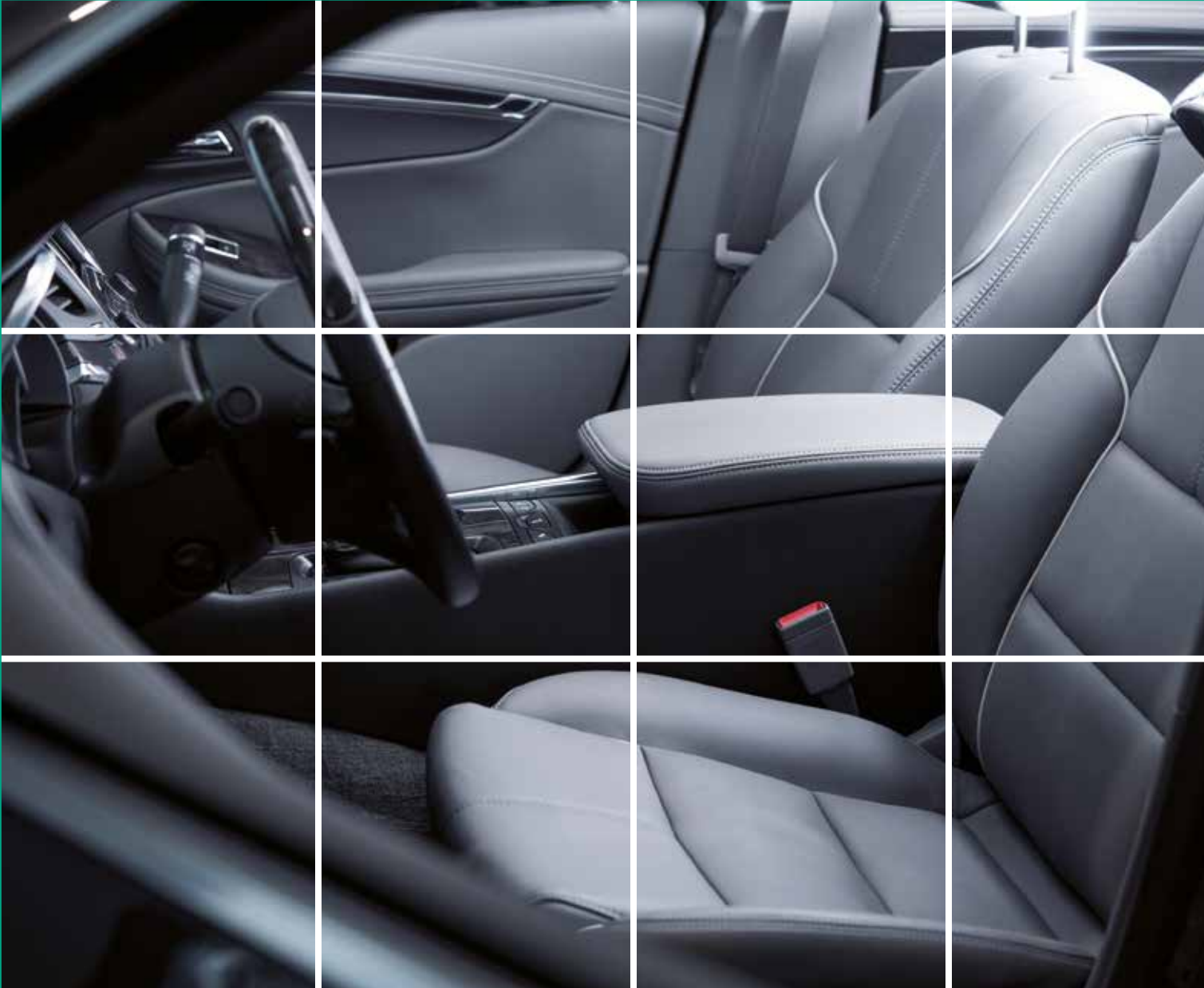

FODERE E COPRISEDILI

SEAT COVERS AND SEAT CUSHIONS

COPRISEDILI IN LINO	pag 192
COMPLETO FODERE BOTTARI	pag 194
COMPLETO FODERE LADY	pag 196
COMPLETO FODERE UNIVERSALI	pag 199
SET FODERE UNIVERSALI	pag 200
COPRISEDILE - FODERA UNIVERSALE	pag 202
SCHIENALE BOTTARI	pag 203
SCHIENALE - FODERA GOODYEAR	pag 209
COMPLETO FODERE GOODYEAR	pag 210
COPRISEDILE GOODYEAR E GULF	pag 211



OHAU IN CANAPA DI LINO

12311-12312-12313

- COPRISEDILE IN TESSUTO DI CANAPA
- LINEN SEAT CUSHION
- HOUSSE DE SIÈGE
- Sitzbezüge
- CUBREASIENTO EN TEJIDO

MASTER 12

12311	marrone	brown
12312	nero	black
12313	grigio	grey



in lino

OHAU

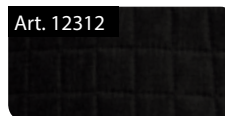

HONOLULU IN CANAPA DI LINO

12314

- COPRISEDILE IN TESSUTO DI CANAPA
- LINEN SEAT CUSHION
- HOUSSE DE SIÈGE
- Sitzbezüge
- CUBREASIENTO EN TEJIDO

MASTER 12

in lino



HONOLULU

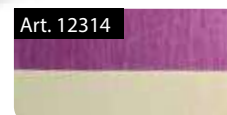

MAUI IN CANAPA DI LINO

12315-12316-12317

- COPRISIDILE IN TESSUTO DI CANAPA
- LINEN SEAT CUSHION
- HOUSSE DE SIÈGE
- Sitzbezüge
- CUBREASIENTO EN TEJIDO

MASTER 12

12315		marrone/nero	brown/black
12316		grigio/nero	grey/black
12317		nero/grigio	black/grey



in lino

MAUI



COLOUR system



UNIVERSALE Universal



WAIKIKI IN CANAPA DI LINO

12308-12309

- COPRISIDILE IN TESSUTO DI CANAPA
- LINEN SEAT CUSHION
- HOUSSE DE SIÈGE
- Sitzbezüge
- CUBREASIENTO EN TEJIDO

MASTER 12

12308		nero	black
12309		viola	violet



in lino

WAIKIKI



COLOUR system



UNIVERSALE Universal

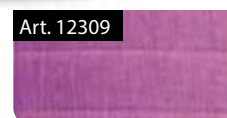
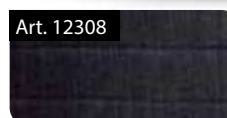

SET FODERE J9

10400-10401-10402

- COMPLETO FODERA UNIVERSALE ELASTICIZZATA
- SET OF UNIVERSAL ELASTICIZED SEAT COVERS
- JEU DE HOUSSES COMPLET ÉLASTIQUE AVEC DESIGN
- Set mit Elastischem Besticktem Universalbezug
- JUEGO DE FUNDAS ELÁSTICAS UNIVERSALES

MASTER 6

10400		nero	black
10401		nero/grigio	black/grey
10402		nero/blu	black/blue

9 pcs



SET COMPLETO:

2 COPRISIEDILI ANTERIORI + 5 APPOGGIATESTA
2 POSTERIORI SEPARATI CON 3 ZIP

COMPLETE SET:

2 FRONT SEATS +5 HEAD RESTS
2 SEPARATE BACKS WITH 3 ZIP

PACKAGING
PVC BAG



Art. 10400

Art. 10401

Art. 10402



SET FODERE JB9

10406-10414

- COMPLETO FODERA UNIVERSALE ELASTICIZZATA
- SET OF UNIVERSAL ELASTICIZED SEAT COVERS
- JEU DE HOUSSES COMPLET ÉLASTIQUE AVEC DESIGN
- Set mit Elastischem Besticktem Universalbezug
- JUEGO DE FUNDAS ELÁSTICAS UNIVERSALES

MASTER 6

10406		nero/grigio	black/grey
10414		nero/blu	black/blue

9 pcs



SET COMPLETO:

2 COPRISIEDILI ANTERIORI + 5 APPOGGIATESTA
2 POSTERIORI SEPARATI CON 3 ZIP

COMPLETE SET:

2 FRONT SEATS +5 HEAD RESTS
2 SEPARATE BACKS WITH 3 ZIP

PACKAGING
PVC BAG



SET FODERE G9

10412

- COMPLETO FODERA UNIVERSALE ELASTICIZZATA
- SET OF UNIVERSAL ELASTICIZED SEAT COVERS
- JEU DE HOUSSES COMPLET ÉLASTIQUE AVEC DESIGN
- Set mit Elastischem Besticktem Universalbezug
- JUEGO DE FUNDAS ELÁSTICAS UNIVERSALES

MASTER 6

10412	nero/grigio	black/grey
-------	-------------	------------



SET COMPLETO:

2 COPRISEDILI ANTERIORI + 5 APPOGGIATESTA
2 POSTERIORI SEPARATI CON 3 ZIP

COMPLETE SET:

2 FRONT SEATS +5 HEAD RESTS
2 SEPARATE BACKS WITH 3 ZIP



Art. 10412



PACKAGING
PVC BAG



5 cuffiette
headrest covers



Zip System
1/2 1/3 2/3



COLOUR
system



UNIVERSALE
Universal



AIR-BAG system
lato porta / d door side

SET FODERE S9

10408-10409

- COMPLETO FODERA UNIVERSALE ELASTICIZZATA
- SET OF UNIVERSAL ELASTICIZED SEAT COVERS
- JEU DE HOUSSES COMPLET ÉLASTIQUE AVEC DESIGN
- Set mit Elastischem Besticktem Universalbezug
- JUEGO DE FUNDAS ELÁSTICAS UNIVERSALES

MASTER 6

10408	nero	black
10409	grigio scuro	dark grey



SET COMPLETO:

2 COPRISEDILI ANTERIORI + 5 APPOGGIATESTA
2 POSTERIORI SEPARATI CON 3 ZIP

COMPLETE SET:

2 FRONT SEATS +5 HEAD RESTS
2 SEPARATE BACKS WITH 3 ZIP



10408
NERO

10409
GRIGIO SCURO

PACKAGING
PVC BAG



5 cuffiette
headrest covers



COLOUR
system



UNIVERSALE
Universal



FASHION LADY

MY SPRING FLOWER

29016 - 29017 - 29018

- COMPLETO FODERE AUTO 100% POLIESTERE
- SET SEAT CAR COVERS 100% POLYESTER
- JEU DE HOUSSES 100% POLYESTER
- Komplet Set Autositzbezüge 100% Polyester
- JUEGO FUNDA ASIENTO 100% POLIESTER

MASTER 6

29016		fiore rosa	pink flower
29017		fiore azzurro	blue flower
29018		fiore verde/rosso	green/red flower

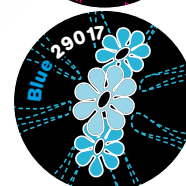

SET COMPLETO:

- 2 COPRISEDILI ANTERIORI
- 5 APPOGGIATESTA
- 2 POSTERIORI SEPARATI
- CON 3 ZIP

COMPLETE SET:

- 2 FRONT SEATS +5 HEAD RESTS
- 2 SEPARATE BACKS WITH 3 ZIP



PACKAGING
PVC BAG



5 cuffiette
headrest covers

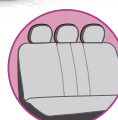

Zip System
1/2 1/3 2/3



AIR-BAG
system



UNIVERSALE
Universal



COLOUR
system

MY STAR

29013 - 29014 - 29015

- COMPLETO FODERE AUTO 100% POLIESTERE
- SET SEAT CAR COVERS 100% POLYESTER
- JEU DE HOUSSES 100% POLYESTER
- Komplet Set Autositzbezüge 100% Polyester
- JUEGO FUNDA ASIENTO 100% POLIESTER

MASTER 6

29013		fiore rosa	pink flower
29014		fiore azzurro	blue flower
29015		fiore verde/viola	green/violet flower



SET COMPLETO:

- 2 COPRISEDILI ANTERIORI
- 5 APPOGGIATESTA
- 2 POSTERIORI SEPARATI CON 3 ZIP

COMPLETE SET:

- 2 FRONT SEATS +5 HEAD RESTS
- 2 SEPARATE BACKS WITH 3 ZIP



PACKAGING PVC BAG



MY FLOWER SWIVEL

29010 - 29011 - 29012

- COMPLETO FODERE AUTO 100% POLIESTERE
- SET SEAT CAR COVERS 100% POLYESTER
- JEU DE HOUSSES 100% POLYESTER
- Komplet Set Autositzbezüge 100% Polyester
- JUEGO FUNDA ASIENTO 100% POLIESTER

MASTER 6

29010		fiore rosa	pink flower
29011		fiore azzurro	blue flower
29012		fiore verde/viola	green/violet flower



SET COMPLETO:

- 2 COPRISEDILI ANTERIORI
- 5 APPOGGIATESTA
- 2 POSTERIORI SEPARATI CON 3 ZIP

COMPLETE SET:

- 2 FRONT SEATS +5 HEAD RESTS
- 2 SEPARATE BACKS WITH 3 ZIP



PACKAGING PVC BAG



MY SWEET KITTY

29022 - 29024

- COMPLETO FODERE AUTO 100% POLIESTERE
- SET SEAT CAR COVERS 100% POLYESTER
- JEU DE HOUSSES 100% POLYESTER
- Komplet Set Autositzbezüge 100% Polyester
- JUEGO FUNDA ASIENTO 100% POLIESTER

MASTER 6

29022		cuore rosa	pink heart
29024		cuore verde	green heart

9 pcs

per tutti modelli auto
all car models

SET COMPLETO:

- 2 COPRISIEDILI ANTERIORI
- 5 APPOGGIATESTA
- 2 POSTERIORI SEPARATI CON 3 ZIP

COMPLETE SET:

- 2 FRONT SEATS +5 HEAD RESTS
- 2 SEPARATE BACKS WITH 3 ZIP



PACKAGING PVC BAG



MY SWEET CAT

29019 - 29020

- COMPLETO FODERE AUTO 100% POLIESTERE
- SET SEAT CAR COVERS 100% POLYESTER
- JEU DE HOUSSES 100% POLYESTER
- Komplet Set Autositzbezüge 100% Polyester
- JUEGO FUNDA ASIENTO 100% POLIESTER

MASTER 6

29019		gattino bianco	white cat
29020		gattino rosa	pink cat

9 pcs

per tutti modelli auto
all car models

SET COMPLETO:

- 2 COPRISIEDILI ANTERIORI
- 5 APPOGGIATESTA
- 2 POSTERIORI SEPARATI CON 3 ZIP

COMPLETE SET:

- 2 FRONT SEATS +5 HEAD RESTS
- 2 SEPARATE BACKS WITH 3 ZIP



PACKAGING PVC BAG



JACQUARD

10023-10024

- COMPLETO FODERA UNIVERSALE ELASTICIZZATA
- SET OF UNIVERSAL ELASTICIZED SEAT COVERS
- JEU DE HOUSSES COMPLET ÉLASTIQUE AVEC DESIGN
- Set mit Elastischem Besticktem Universalbezug
- JUEGO DE FUNDAS ELÁSTICAS UNIVERSALES

MASTER 6

10023		grigio	grey
10024		blu	blue



SET COMPLETO:
2 COPRISEDILI ANTERIORI + 5 APPOGGIATESTA
2 POSTERIORI SEPARATI CON 3 ZIP

COMPLETE SET:
2 FRONT SEATS +5 HEAD RESTS
2 SEPARATE BACKS WITH 3 ZIP



PACKAGING
PVC BAG



5 cuffiette
headrest covers



COLOUR
system



UNIVERSALE
Universal

Art. 10023

Art. 10024

EMBROIDERY

10027-10028-10029

- COMPLETO FODERA UNIVERSALE ELASTICIZZATA
- SET OF UNIVERSAL ELASTICIZED SEAT COVERS
- JEU DE HOUSSES COMPLET ÉLASTIQUE AVEC DESIGN
- Set mit Elastischem Besticktem Universalbezug
- JUEGO DE FUNDAS ELÁSTICAS UNIVERSALES

MASTER 6

10027		ricamo blu	blue
10028		ricamo grigio	grey
10029		ricamo rosso	red



PACKAGING
PVC BAG



5 cuffiette
headrest covers



COLOUR
system



UNIVERSALE
Universal



AIR-BAG system
lato porta / door side

Art. 10027

Art. 10028

Art. 10029

SET FODERE J2

10403-10404-10405

- SET 2 FODERE UNIVERSALI ELASTICIZZATE
- SET OF UNIVERSAL ELASTICIZED SEAT COVERS
- JEU DE HOUSSES COMPLET ÉLASTIQUE AVEC DESIGN
- Set mit Elastischem Besticktem Universalbezug
- JUEGO DE FUNDAS ELÁSTICAS UNIVERSALES

MASTER 12

10403		nero	black
10404		grigio	grey
10405		blu	blue

2 pcs



Art. 10403

Art. 10404

Art. 10405



PACKAGING
PVC BAG



2 cuffiette
headrest covers



COLOUR
system



UNIVERSALE
Universal



AIR-BAG system
lato porta / d oor side

SET FODERE S2

10410-10411

- SET 2 FODERE UNIVERSALI ELASTICIZZATE
- SET OF UNIVERSAL ELASTICIZED SEAT COVERS
- JEU DE HOUSSES COMPLET ÉLASTIQUE AVEC DESIGN
- Set mit Elastischem Besticktem Universalbezug
- JUEGO DE FUNDAS ELÁSTICAS UNIVERSALES

MASTER 12

10410		nero	black
10411		grigio scuro	dark grey

2 pcs



Art. 10410

Art. 10411



PACKAGING
PVC BAG



2 cuffiette
headrest covers



COLOUR
system



UNIVERSALE
Universal



AIR-BAG system
lato porta / d oor side

SET FODERE JB2

10407-10415

- SET 2 FODERE UNIVERSALI ELASTICIZZATE
- SET OF UNIVERSAL ELASTICIZED SEAT COVERS
- JEU DE HOUSSES COMPLET ÉLASTIQUE AVEC DESIGN
- Set mit Elastischem Besticktem Universalbezug
- JUEGO DE FUNDAS ELÁSTICAS UNIVERSALES

MASTER 12

10407	nero	black
10415	nero/blu	black/blue

2 pcs



Art. 10407

Art. 10415



PACKAGING PVC BAG



2 cuffiette headrest covers



COLOUR system



UNIVERSALE Universal



AIR-BAG system lato porta / d door side

2 FODERE G2

10413

- SET 2 FODERE UNIVERSALI ELASTICIZZATE
- SET OF UNIVERSAL ELASTICIZED SEAT COVERS
- JEU DE HOUSSES COMPLET ÉLASTIQUE AVEC DESIGN
- Set mit Elastischem Besticktem Universalbezug
- JUEGO DE FUNDAS ELÁSTICAS UNIVERSALES

MASTER 12

10413	nero/grigio	black/grey
--------------	-------------	------------

2 pcs



Art. 10413



PACKAGING PVC BAG



2 cuffiette headrest covers



COLOUR system



UNIVERSALE Universal



AIR-BAG system lato porta / d door side

SUNNY TRASPIRANTE

10426

- COPRISEDILE IN TESSUTO TRASPIRANTE
- SEAT COVER
- HOUSSE DE SIÈGE
- Sitzbezüge
- CUBREASIENTO EN TEJIDO

MASTER 12

10426 blue	blu	blue
10426 dark grey	grigio scuro	dark grey
10426 black	nero	black



PACKAGING
PVC BAG

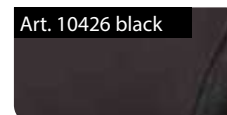
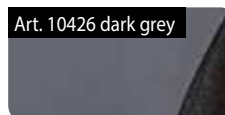
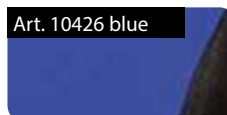

FODERE TRAPUNTA

10416 - 10417

- FODERA UNIVERSALE ELASTICIZZATA
- UNIVERSAL ELASTICIZED SEAT COVERS
- JEU DE HOUSSES COMPLET ÉLASTIQUE AVEC DESIGN
- Elastischem Besticktem Universalbezug
- FUNDAS ELÁSTICAS UNIVERSALES

MASTER 6

10416	colori fantasia assortiti	colour assorted
10417	tinta unita	solid color



AUTO
JEEP/SUV
MONOVOLUMI
CAMION/CAMPER



100% COTONE DRILL 200GR
BORDATURA ELASTICA
RINFORZATA
IMBOTTITURA 220GR
100% DRILL COTTON 200GR
REINFORCED
ELASTIC EDGES
QUILTING 220GR

10417
COLORI TINTA UNITA



TOP CLASS POGGIARENI

12072

- SCHIENALE IN TESSUTO
SAGOMATURA UNIVERSALE PER TUTTI I SEDILI
- FABRIC SEAT CUSHION
UNIVERSAL SHAPING FOR ALL SEATS
- COUSSIN DE SIEGE EN TISSU.
LIGNE UNIVERSELLE POUR TOUS LES SIÈGES
- Zurück in Stoff.
Universelle Form für alle Size
- RESPALDO TELA.
PERFILADO UNIVERSAL PARA TODOS

MASTER 20

12072	nero	black
-------	------	-------



PACKAGING
PVC BAG

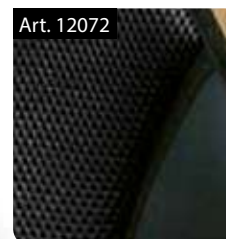

Art. 12072



COLOUR
system



UNIVERSALE
Universal

JAVA

12085-12086-12087

- SCHIENALE IN TESSUTO
SAGOMATURA UNIVERSALE PER TUTTI I SEDILI
- FABRIC SEAT CUSHION
UNIVERSAL SHAPING FOR ALL SEATS
- COUSSIN DE SIEGE EN TISSU.
LIGNE UNIVERSELLE POUR TOUS LES SIÈGES
- Zurück in Stoff.
Universelle Form für alle Size
- RESPALDO TELA.
PERFILADO UNIVERSAL PARA TODOS

MASTER 12

12085	blu	blue
12086	grigio	grey
12087	nero	black



PACKAGING
PVC BAG



Art. 12085

Art. 12086

Art. 12087



CON MAGNETI CHE STIMOLANO
LA CIRCOLAZIONE SANGUIGNA
WITH MAGNETS FOR STIMULATION
OF BLOOD CIRCULATION



COLOUR
system



UNIVERSALE
Universal

EMBROIDERY

12158

- SCHIENALE IN TESSUTO
SAGOMATURA UNIVERSALE PER TUTTI I SEDILI
- FABRIC SEAT CUSHION
UNIVERSAL SHAPING FOR ALL SEATS
- COUSSIN DE SIEGE EN TISSU.
LIGNE UNIVERSELLE POUR TOUS LES SIÈGES
- Zurück in Stoff.
Universelle Form für alle Size
- RESPALDO TELA.
PERFILADO UNIVERSAL PARA TODOS

MASTER 20

12158 grigio grey



PACKAGING
PVC BAG



Art. 12158



WOOD

12150

- SCHIENALE IN BAMBOO
BAMBOO SEAT CUSHION
- COUSSIN DE SIEGE EN BAMBOU
Bambus-Rückenlehne
- RESPALDO BAMBOO

MASTER 20

12150 beige



PACKAGING
PVC BAG



**migliore traspirabilità
for better perspiration**

Art. 12150



PAPER

12155-12156-12157

- SCHIENALE IN FIBRA DI RAFFIA
- RAFIA SUMMER SEAT CUSHION
- COUSSIN DE SIEGE D'ETE EN FIBRE DE RAFFIA
- Sommer-Rückenlehne aus Raffia-Bast
- RESPALDO DE VERANO EN FIBRA DE RAFIA

MASTER 20

12155	beige
12156	grigio grey
12157	nero black

1 pc



COLOUR system



UNIVERSALE Universal



PACKAGING PVC BAG

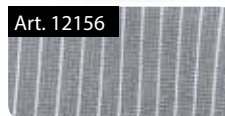

PAPER CUSCINO

12305

- SEDUTA IN FIBRA DI RAFFIA
- RAFIA SUMMER SEAT CUSHION
- COUSSIN DE SIEGE D'ETE EN FIBRE DE RAFFIA
- Sommer-Rückenlehne aus Raffia-Bast
- RESPALDO DE VERANO EN FIBRA DE RAFIA

MASTER 24

12305	nero black
-------	------------

1 pc



CUSCINO SINGOLO

BORDATURA ELASTICA RINFORZATA
REINFORCED ELASTIC EDGES



PACKAGING PVC BAG



COLOUR system



UNIVERSALE Universal



CARRERA

12300-12301

- SCHIENALE IN BAMBOO
- BAMBOO SEAT CUSHION
- COUSSIN DE SIEGE EN BAMBOU
- Bambus-Rückenlehne
- RESPALDO BAMBOO

MASTER 20

12300	nero / black
12301	grigio / grey



PACKAGING
PVC BAG



CALIFORNIA

12302-12303-12304

- SCHIENALE IN FIBRA DI RAFFIA CON PALLINE
- RAFIA SUMMER SEAT CUSHION WITH BALLS
- COUSSIN DE SIEGE D'ETE EN FIBRE DE RAFFIA
- Sommer-Rückenlehne aus Raffia-Bast
- RESPALDO DE VERANO EN FIBRA DE RAFIA

MASTER 20

12302	avorio / ivory
12303	nero / black
12304	grigio / grey

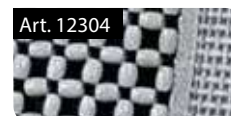

DOUBLE FACE COMBI

12151

- COPPIA SCHIENALI IMBOTTITI
DOUBLE FACE COMBI, COLORI ASSORTITI
- SET OF 2 PCS DOUBLE FACE COMBI PADDED
SEAT CUSHIONS, ASSORTED COLORS
- COULEURS ASSORTIS
- Sortierte Farben
- COLORES CLASIFICADOS

MASTER 24



**DOUBLE
FACE**

Coppia di schienali composta nella parte anteriore da carta tessile in fibra naturale 100% (paglia), nella parte posteriore da un tessuto in jacquard 100% trapuntati con ovatta poliflex 100 grammi, l'ovatta poliflex è una fibra che assorbe liquidi e permette il passaggio d'aria rimanendo sempre dello stesso spessore ed è anallergica, all'interno delle parti c'è il feltro 700 grammi extra rigido, il feltro è un materiale composto da un mix di fibre tessili naturali rigenerate (cotone) e fibre sintetiche (acriliche e polipropileniche), di colore grigio termofissato: con caratteristiche termoplastiche, ad elevato potere fonoassorbente, fonoisolante e termico; prodotto ecologico e completamente riciclabile. La coppia di schienali si adatta alla perfezione a qualsiasi tipo di sedile, adatto a tutte le stagioni, e scusate se è poco è di produzione italiana.

**COLORI
ASSORTITI**



COLOUR
system



UNIVERSALE
Universal



MALDIVE

12128

- SCHIENALE PAGLIA
- STRAW CUSHION
- COUVRE-SIÈGE EN PAILLE
- Stroh-Rückenlehne
- RESPALDO DE PAJA

MASTER 20

12128 beige

1 pc

100%
PER TUTTI I MODELLI AUTO
ALL CAR MODELS

traspirante - breathable



PACKAGING
PVC BAG



paglia

Art. 12128



- **SCHIENALE ESTIVO IN FIBRA DI PAGLIA**
Migliore traspirabilità
Sagomatura universale per tutti i sedili
Applicazione facile e veloce con bordo in tinta
- **STRAW SUMMER SEAT CUSHION**
For better perspiration
Universal shaping for all seats.
Easy and quick application with edge
in matching colours.

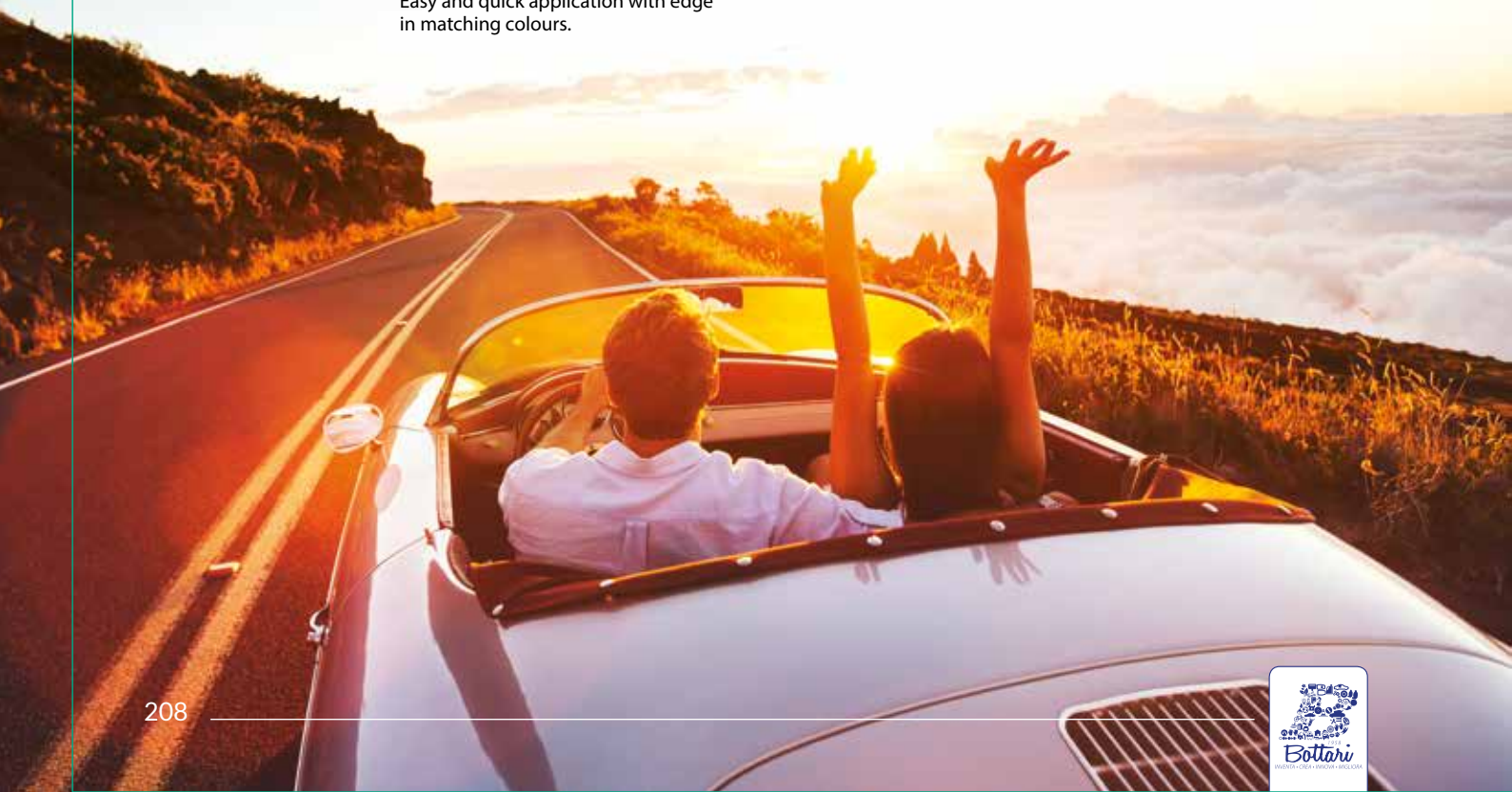

MAGNETIC

77127-77128-77129

- SCHIENALE ANATOMICO MASSAGGIANTE
- ANATOMIC, MAGNETIC, MASSAGING SEAT
- DOSSIER ANATOMIQUE MAGNETIQUE AVEC EFFET DE MASSAGE
- Körpergerechte, Magnetisch Massierende
- RESPALDO ANATÓMICO MAGNÉTICO CON MASAJE

MASTER 12

77127	blu	blue
77128	grigio	grey
77129	nero	black

1 pc

CON MAGNETI CHE STIMOLANO LA CIRCOLAZIONE SANGUIGNA WITH MAGNETS FOR STIMULATION OF BLOOD CIRCULATION



PACKAGING PVC BAG



COLOUR system



UNIVERSALE Universal

GOODYEAR



FODERA SINGOLA

77122

- FODERA UNIVERSALE ELASTICIZZATA
- UNIVERSAL ELASTICIZED SEAT COVERS
- JEU DE HOUSSES COMPLET ÉLASTIQUE AVEC DESIGN
- Elastischem Besticktem Universalbezug
- JUEGO DE FUNDAS ELÁSTICAS UNIVERSALES

MASTER 12

77122	grigio	grey
-------	--------	------

1 pc



PACKAGING PVC BAG



GOODYEAR

AUTO
JEEP/SUV
MONOVOLUMI
CAMION/CAMPER

super resistente
premium quality

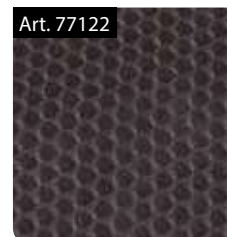

COLOUR system



UNIVERSALE Universal

SPEED UP1

77123

- COMPLETO FODERA UNIVERSALE ELASTICIZZATA
- SET OF UNIVERSAL ELASTICIZED SEAT COVERS
- JEU DE HOUSSES COMPLET ÉLASTIQUE AVEC DESIGN
- Set mit Elastischem Besticas Universales
- JUEGO DE FUNDAS ELÁSTICAS UNIVERSALES



MASTER 12

77123 grey		nero/grigio	black/grey
77123 red		nero/rosso	black/red
77123 blue		nero/blu	black/blue

PACKAGING PVC BAG



SET COMPLETO
 2 COPRISEDILI ANTERIORI - 2 APPOGGIATESTA - 2 POSTERIORI SEPARATI

COMPLETE SET
 2 FRONT SEATS - 2 HEAD RESTS - 2 SEPARATE BACKS

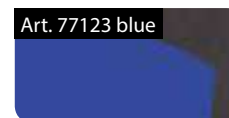
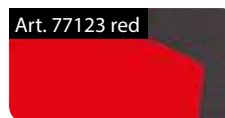
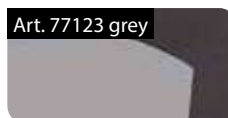

SPEED UP2

77124

- COMPLETO FODERA UNIVERSALE ELASTICIZZATA
- SET OF UNIVERSAL ELASTICIZED SEAT COVERS
- JEU DE HOUSSES COMPLET ÉLASTIQUE AVEC DESIGN
- Set mit Elastischem Besticas Universales
- JUEGO DE FUNDAS ELÁSTICAS UNIVERSALES



MASTER 12

77124 grey		nero/grigio	black/grey
77124 red		nero/rosso	black/red
77124 blue		nero/blu	black/blue

PACKAGING PVC BAG



SET COMPLETO
 2 COPRISEDILI ANTERIORI - 2 APPOGGIATESTA - 2 POSTERIORI SEPARATI

COMPLETE SET
 2 FRONT SEATS - 2 HEAD RESTS - 2 SEPARATE BACKS

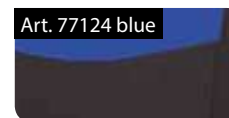
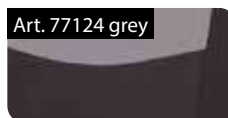

FODERA SEDILE SINGOLA

77119

- COPRISIEDILE IN TESSUTO
- SEAT COVER
- HOUSSE DE SIÈGE
- Sitzbezüge
- CUBREASIENTO EN TEJIDO

MASTER 12

77119 Black	nero	black
77119 Blue	blu	blue
77119 Grey	grigio	grey

1 pc

100% UNIVERSAL



PACKAGING
PVC BAG

**TESSUTO
TRASPIRANTE
BREATHABLE**



**AIR-BAG
system**



**UNIVERSALE
Universal**



**COLOUR
system**

FODERA SEDILE SINGOLA

76120

- COPRISIEDILE IN TESSUTO
- SEAT COVER
- HOUSSE DE SIÈGE
- Sitzbezüge
- CUBREASIENTO EN TEJIDO

MASTER 12

76120 blue	nero/blu	black/blue
76120 grey	nero/grigio	black/grey
76120 red	nero/rosso	black/red

1 pc

100% UNIVERSAL



PACKAGING
PVC BAG

Coprisiedile in tessuto
Migliore traspirabilità
Sagomatura universale per tutti i sedili
Seat cover
High breathability
One size fits all



**AIR-BAG
system**



**UNIVERSALE
Universal**



**COLOUR
system**



ACCESSORI INTERNI

INTERIOR ACCESSORIES

SUPPORTO VENDITA ACCESSORI INTERNI



www.Bottari.it
Bottari
ITALY





ACCESSORI INTERNI

INTERIOR ACCESSORIES

COPRIVOLANTI GOODYEAR	pag 214
COPRIVOLANTI BOTTARI	pag 215
COPRIVOLANTI BOTTARI-REVOLUTION	pag 216
POMELLI	pag 219
BRACCIOLI	pag 220
PROTEGGI E SALVA SEDILE	pag 221
SEGGIOLINI PER BAMBINI	pag 222
ACCESSORI BOTTARI	pag 223
GRIGLIE E RETI DI SEPARAZIONE	pag 224
PEDANA MULTIUSO GOODYEAR	pag 225
PEDANA MULTIUSO BOTTARI	pag 226
ACCESSORI BOTTARI E GOODYEAR	pag 228

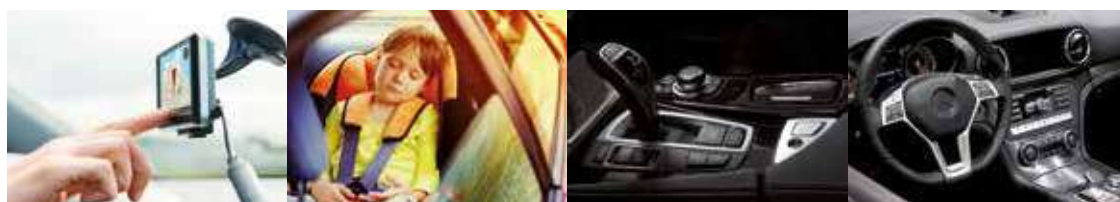

COMFORT PREMIUM

77070

- COPRIVOLANTE
- STEERING WHEEL COVER COMFORTER
- COUVRE-VOLANT POUR AUTO
- Lenkradbezug für Auto
- FUNDA VOLANTE PARA AUTO



MASTER 12

77070

Ø 37>39 nero/black



Art. 77070



Ø 37-39 cm

COMFORT PREMIUM

77071

- COPRIVOLANTE
- STEERING WHEEL COVER COMFORTER
- COUVRE-VOLANT POUR AUTO
- Lenkradbezug für Auto
- FUNDA VOLANTE PARA AUTO



MASTER 12

77071

Ø 37>39 grigio/grey



Art. 77071



Ø 37-39 cm

COMFORT PREMIUM

77072

- COPRIVOLANTE
- STEERING WHEEL COVER COMFORTER
- COUVRE-VOLANT POUR AUTO
- Lenkradbezug für Auto
- FUNDA VOLANTE PARA AUTO



MASTER 12

77072

Ø 37>39 beige



Art. 77072



Ø 37-39 cm

EXAGON

16744-16745

- COPRIVOLANTE
- STEERING WHEEL COVER
- COUVRE-VOLANT POUR AUTO
- Lenkradbezug für Auto
- FUNDA VOLANTE PARA AUTO



MASTER 12

16744		Ø 37>39 nero/black
16745		Ø 35>37 nero/black



Art. 16744



Ø 37-39 cm

Art. 16745



Ø 35-37 cm

ERAGON

16741-16742-16743

- COPRIVOLANTE
- STEERING WHEEL COVER
- COUVRE-VOLANT POUR AUTO
- Lenkradbezug für Auto
- FUNDA VOLANTE PARA AUTO



MASTER 12

16741		nero-grigio	black-grey
16742		nero-rosso	black-red
16743		nero-blu	black-blue



Ø 37-39 cm



FILO GRIGIO



FILO ROSSO



FILO BLU

ROAD

16341-16342-16343
16284-16285-16286
16344

- COPRIVOLANTE
- STEERING WHEEL COVER
- COUVRE-VOLANT POUR AUTO
- Lenkradbezug für Auto
- FUNDA VOLANTE PARA AUTO



- Adatto per la maggior parte delle auto e autocarri pick-up
- Protegge e abbellisce l'interno delle auto
- Impugnatura morbida e comoda
- Fresco in estate, caldo in inverno

- Fits most cars & pick-up trucks
- Protects and beautifies the cars interior
- Soft comfortable grip
- Cool in summer, warm in winter



MASTER 12

16341		nero-grigio	black-grey	Ø 35/37 cm
16284		nero-grigio	black-grey	Ø 37/39 cm
16344		nero-grigio	black-grey	Ø 39/41 cm

Art. 16341



Ø 35-37 cm

Art. 16284



Ø 37-39 cm

Art. 16344



Ø 39-41 cm



FILO GRIGIO

16342		nero-rosso	black-red	Ø 35/37 cm
16285		nero-rosso	black-red	Ø 37/39 cm

Art. 16342



Ø 35-37 cm

Art. 16285



Ø 37-39 cm



FILO ROSSO

16343		nero-blu	black-blue	Ø 35/37 cm
16286		nero-blu	black-blue	Ø 37/39 cm

Art. 16343



Ø 35-37 cm

Art. 16286



Ø 37-39 cm



FILO BLU

STYLISH

16749-16754-16767-16768

- COPRIVOLANTE
- STEERING WHEEL COVER
- COUVRE-VOLANT POUR AUTO
- Lenkradbezug für Auto
- FUNDA VOLANTE PARA AUTO



Art. 16768



Ø 39-41 cm

Art. 16767



Ø 41-45 cm

Art. 16749



Ø 35-37 cm

Art. 16754



Ø 37-39 cm

MASTER 12

16768		per auto e furgoni	for car and vans	Ø 39-41
16767		per furgoni	for trucks and vans	Ø 41-45
16749		per auto	for car	Ø 35-37
16754		per auto	for car	Ø 37-39

ORION

16283-16287-16288-16289

- COPRIVOLANTE
- STEERING WHEEL COVER
- COUVRE-VOLANT POUR AUTO
- Lenkradbezug für Auto
- FUNDA VOLANTE PARA AUTO



MASTER 12

16283		nero	black
16287		nero-grigio	black-grey
16288		nero-rosso	black-red
16289		nero-blu	black-blue



Art. 16283



Art. 16287



Art. 16288



Art. 16289



Ø 37-39 cm
misura unica

F 104

17184-17185-17187

- COPRIVOLANTE
- STEERING WHEEL COVER
- COUVRE-VOLANT POUR AUTO
- Lenkradbezug für Auto
- FUNDA VOLANTE PARA AUTO



MASTER 12

17184		CHROMED	Ø 35/37 cm
17185		CHROMED	Ø 37/39 cm
17187		CHROMED	Ø 39/41 cm



Art. 17184



Ø 35-37 cm

Art. 17185



Ø 37-39 cm

Art. 17187



Ø 39-41 cm

CON INSERTI CROMATI
CHROMED INSERTS



MESH

13604-13605-13606

- COPRIVOLANTE
- STEERING WHEEL COVER
- COUVRE-VOLANT POUR AUTO
- Lenkradbezug für Auto
- FUNDA VOLANTE PARA AUTO

MASTER 24

13604		nero-rosso	black-red
13605		nero-blu	black-blue
13606		nero-grigio	black-grey



POLIESTERE NIDO D'APE
MESH MATERIAL

Art. 13604-5-6



Ø 37-39 cm

SPORTING

16010-16011

- COPRIVOLANTE UNIVERSALE
- UNIVERSAL STEERING WHEEL COVER
- COUVRE-VOLANT UNIVERSEL
- Universaler Lenkradbezug
- CUBREVOLANTE UNIVERSAL

MASTER 25

16010		Ø 37/43 cm
16011		Ø 33/37 cm



Antisudore
Anti sweat

Art. 16010



Ø 37-43 cm

Art. 16011



Ø 33-37 cm

F 116

17186

- COPRIVOLANTE
- STEERING WHEEL COVER
- COUVRE-VOLANT POUR AUTO
- Lenkradbezug für Auto
- FUNDA VOLANTE PARA AUTO



MASTER 12

17186	CHROMED	Ø 37/39 cm
--------------	---------	------------



CON INSERTI CROMATI
CHROMED INSERTS

Art. 17186



Ø 37-39 cm

CHAMPION

16015

- COPRIVOLANTE CON LACCI
- STEERING WHEEL COVER WITH LACES
- COUVRE-VOLANT AVEC FILETS
- Lenkradüberzug mit Schlingen
- CUBREVOLANTE CON CORDONES

MASTER 120 INNER 24

16015	per auto	car
--------------	----------	-----

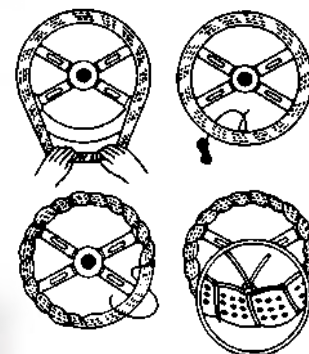

RODEO DRIVE TPE

16746

- COPRIVOLANTE
- STEERING WHEEL COVER
- COUVRE-VOLANT POUR AUTO
- Lenkradbezug für Auto
- FUNDA VOLANTE PARA AUTO



MASTER 12

16746

Ø 37>39 nero/grigio



Art. 16746



Ø 37-39 cm

SUNSET BOULEVARD TPE

16747

- COPRIVOLANTE
- STEERING WHEEL COVER
- COUVRE-VOLANT POUR AUTO
- Lenkradbezug für Auto
- FUNDA VOLANTE PARA AUTO



MASTER 12

16747

Ø 37>39 nero/grigio



Art. 16747



Ø 37-39 cm



FIRST CLASS: Grazie all'impiego del nuovo elastomero "TPE" il coprivotante Bottari garantisce una presa sicura ed una sensazione di morbida piacevolezza al tatto, eliminando al contempo gli odori tipici dei normali materiali plastici e garantendo una totale sicurezza al contatto con la pelle nel rispetto dell'ambiente.

FIRST CLASS: using the new "TPE" elastomer the Bottari steering wheel cover enables a strong grip and a comfortable feeling to the touch, erasing the typical plastic odour and granting a total safety for the skin, and environmental friendly.

CLUB

16142

- POMELLO IN VERA PELLE
- REAL LEATHER GEAR KNOB
- POMMEAU DE LEVIER DE VITESSE EN CUIR
- Knauf aus Echtleder
- POMO CAMBIO EN PIEL



MASTER 96 INNER 12



VENERE

17430

- POMELLO CAMBIO
- GEAR KNOB
- POMMEAU DE LEVIER DE VITESSE
- Universal Knauf
- POMO PALANCA DE CAMBIO

dotato anche di speciale innesto per
FIAT PUNTO

MASTER 48 INNER 12



SIRIO

17431-17432-17433-17434

- POMELLO CAMBIO
- GEAR KNOB
- POMMEAU DE LEVIER DE VITESSE
- Universal Knauf
- POMO PALANCA DE CAMBIO

MASTER 48 INNER 12

17431		nero-rosso	black-red
17432		nero-blu	black-blue
17433		nero-grigio	black-grey
17434		nero	black



APACHE

13402

- POMELLO CAMBIO
- GEAR KNOB
- POMMEAU DE LEVIER DE VITESSE
- Universal Knauf
- POMO PALANCA DE CAMBIO



ALLUMINIO + PELLE
ALUMINIUM + LEATHER

MASTER 48 INNER 12

13402		giallo-nero	yellow-black
--------------	--	-------------	--------------



SPEED POWER

17406-17407

- POMELLO CAMBIO
- GEAR KNOB
- POMMEAU DE LEVIER DE VITESSE
- Universal Knauf
- POMO PALANCA DE CAMBIO

MASTER 48 INNER 12

17406		nero-rosso	black-red
17407		nero-argento	black-silver



POMELLO IN ACCIAIO

16144

- POMELLO PER VOLANTE
- STEERING WHEEL KNOB
- POMMEAU DE VOLANT
- Lenkradknauf
- TOPO DE VOLANTE



MASTER 50

16144	acciaio	steel
-------	---------	-------

JOLLY BOX

16115

- BRACCIOLO PORTAOGGETTI
- MULTI CONSOLE BOX
- BRACCIOLO MULTIUSO + SUPPORTO
- Multi console box + support
- ACCOUDOIR MULTIFONCTION + SUPPORT



16115	nero	black
-------	------	-------

MASTER 12

MAGIC BOX

16118-16119

- BRACCIOLO PORTAOGGETTI
- MULTI CONSOLE BOX
- BRACCIOLO MULTIUSO + SUPPORTO
- Multi console box + support
- ACCOUDOIR MULTIFONCTION + SUPPORT



MASTER 12

16118	chromed style
16119	carbon style

16119



16118

BLACK/CHROMED ARROW

16462-16463

- BRACCIOLO PORTAOGGETTI
- MULTI CONSOLE BOX
- BRACCIOLO MULTIUSO + SUPPORTO
- Multi console box + support
- ACCOUDOIR MULTIFONCTION + SUPPORT



16463

16462

MASTER 12

16462	nero	black
16463	cromato	chromed

ALTEZZA REGOLABILE
PROTEZIONI SPECIALI IN GOMMA
INSTALLABILE IN AUTO DI MEDIO
VOLUME CON SUPPORTO
CON APERTURA AUTOMATICA
ADJUSTABLE HEIGHT
SPECIAL RUBBER PROTECTIONS
INSTALL IN CAR OF MEDIUM VOLUME
WITH SUPPORT AUTO OPENING

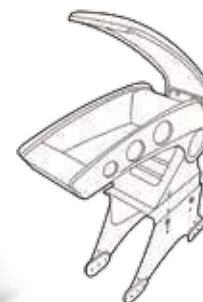

PROTEGGI SEDILE SINGOLO

12198

- PROTEGGI SEDILE ANTERIORE SINGOLO
- FRONT SEAT PROTECTIVE COVER SINGLE PIECE
- HOUSSE DE PROTECTION DU SIEGE AVANT PIECE UNIQUE
- Vordersitzschutz einzel Stuck
- PROTECTOR ASIENTO ANTERIOR UNIDAD UNICA

MASTER 20

12198	nero	black
-------	------	-------

MULTIUSO
ADATTABILE PER VARI
TIPI DI SEDILI
CON ELASTICI

**MASSIMA
VESTIBILITÀ
BEST FITTING**

**MULTIPURPOSE
FITS TO VARIOUS
KINDS OF SEATS
WITH ELASTIC STRIPS**



PACKAGING



SALVA SEDILE IN PVC

12199

- PELLICOLA PROTETTIVA PER SCHIENALE SEDILE ANTERIORE
- SEAT BACK PROTECTOR MADE WITH CLEAR PVC, CONVENIENTLY PROTECT
- FILM PROTECTEUR POUR DOSSIER DU SIEGE AVANT
- Schutz für die Sitzrückseite aus Durchsichtigem Pvc
- PROTECCIÓN POR LA PARTE DE ATRÁS DEL ASIENTO

MASTER 48 INNER 12

12199	58 x 44 cm
-------	------------

- MULTIUSO • CON ELASTICI
- MULTIPURPOSE • WITH ELASTIC STRIPS



SALVA SEDILE IN PVC

21954

- PELLICOLA PROTETTIVA PER SCHIENALE SEDILE ANTERIORE
- SEAT BACK PROTECTOR MADE WITH CLEAR PVC, CONVENIENTLY PROTECT
- FILM PROTECTEUR POUR DOSSIER DU SIEGE AVANT
- Schutz für die Sitzrückseite aus Durchsichtigem Pvc
- PROTECCIÓN POR LA PARTE DE ATRÁS DEL ASIENTO

MASTER 72 INNER 6

21954	68 x 44,5 cm
-------	--------------

- MULTIUSO • CON VELCRO E BIADESIVO
- MULTIPURPOSE • WITH VELCRO



TAMBU PREMIUM

16784

- SEGGIOLINO PER BAMBINI
- BABY SEAT
- SIEGE AUTO POUR ENFANTS
- Kindersitz
- ASIENITO INFANTIL

MASTER 12

16784

assorted colours



UNIVERSALE 15-36 kg



040117

Il Vostro seggiolino per bambini è conforme alla Norma Europea ECE R44/04 Gruppo Universale 2/3, 15 - 36 kg.



High Quality
TESSUTO TRASPIRANTE LAVABILE
100%



6 > 12 ANNI/YEARS

15/36KG



TAMBU

16781

- SEGGIOLINO AUTO PER BAMBINO KG 15-36
- CHILD SEAT KG 15-36
- SIÈGE-BEBÉ POUR BEBÉ DE KG 15-36
- Auto-Kindeesiz kg 15-36
- SILLITA COCHE PARA NIÑOS KG 15-36

MASTER 12

16781

assorted colours



UNIVERSALE 15-36 kg



040117

Il Vostro seggiolino per bambini è conforme alla Norma Europea ECE R44/04 Gruppo Universale 2/3, 15 - 36 kg.

NUOVA VERSIONE
ANCORA PIÙ CONFORTEVOLE



6 > 12 ANNI/YEARS

15/36KG

High Quality
TESSUTO TRASPIRANTE LAVABILE
100%

FRAME

16379

FISSAGGIO CON VENTOSA
PER APPARECCHI
FINO A 110 mm

FIXING WITH SUCTION CUP
FOR DEVICES UP TO 110 mm

16379 FRAME

Porta Telefono e Porta Navigatore Small con clip a molla (apertura max 11 cm) Rotazione 360° Ventosa con pomello sottovuoto Ghiera di tensione a vite

Phone and Small GPS Clip Holder (max. width 11 cm) 360° Rotation Suction cup with vacuum knob Friction Sleeve



100% universale **MP3 - MP4**
per tutti i telefoni smartphone-tablet, iPhone-iPad



MOBILE



PDA



GPS



MASTER 48 INNER 12

FRAME ULTRA

16380

FISSAGGIO CON VENTOSA
PER APPARECCHI
FINO A 210 mm

FIXING WITH SUCTION CUP
FOR DEVICES UP TO 210 mm

MASTER 48 INNER 12

16380 FRAME ULTRA

Porta ipad/tablet 11" e Navigatore XL a clip (apertura max 21 cm). Massima regolazione. Ventosa con clip sottovuoto. Pomelli di tensione a vite.

Ipad/tablet and XL size GPS Clip Holder (max. width 21 cm). Extended Rotation. Suction cup with vacuum clip. Friction knobs.



100% universale
per tutti i telefoni smartphone-tablet, iPhone-iPad

EASY

16135

- PORTA TELEFONO E NAVIGATORE SATELLITARE
- CAR TELEPHONE DOOR AND SATELLITE NAVIGATOR
- PORTE NAVIGATEUR SATELLITAIRE ET ORDINATEUR
- Tragbarer Satelliten-Navigator und elektronisches Notebook
- SOPORTE PARA GPS/PDA

FISSAGGIO CON VENTOSA E ALLA PRESA D'ARIA PER APPARECCHI FINO A 100 mm
FIXING WITH SUCTION CUP AND TO AIR VENT FOR DEVICES UP TO 100 mm

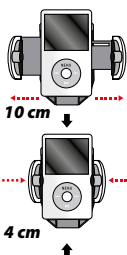

MP3 - MP4 **MOBILE**



PDA

GPS



MASTER 60 INNER 30

GRIGLIE SICUREZZA

16099-16102

- GRIGLIA DI SEPARAZIONE, TRASPORTO ANIMALI E MERCE
- UNIVERSAL DOG AND GOODS CARGO GUARD
- GRILLE POUR LE TRASPORT DES ANIMAUX ET MARCHANDISE
- Universal Trenngitter für den Transport von Tieren und Waren
- SEPARADOR PARA EL TRANSPORTE DE ANIMALES Y MERCANCIA

REGOLABILE



ADJUSTABLE

MASTER 6

16099	3 elementi
16102	2 elementi



16099

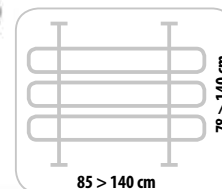

16102

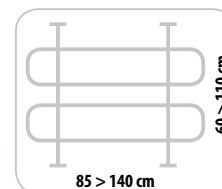

RETE PER BAULE

16374

- RETE ELASTICA PER BAULE
- UNIVERSAL ELASTICISED NET FOR CAR BOOTS
- FILET ÉLASTIQUE POUR COFFRE UNIVERSEL
- Gumminetz für Universalkoffer
- RED ELÁSTICA UNIVERSAL PARA MALETERO



MASTER 24 INNER 6

16374	85 x 35 cm
--------------	------------

RETE SEPARAZIONE

16103

- TRASPORTO ANIMALI E MERCE
- DOG AND GOODS CARGO GUARD
- FILET POUR LE TRASPORT DES ANIMAUX ET MARCHANDISE UNIVERSELLE
- Universalnetz für den Transport von Tieren und Waren
- RED PARA EL TRANSPORTE DE ANIMALES Y MERCANCIA UNIVERSAL



MASTER 24

16103	150 x 60 cm
--------------	-------------

PEDANA MULTIUSO

77177-77178

- PEDANA MULTIUSO PROTETTIVA
- MULTI PURPOSE TRUNK MAT
- PEDANA POLYVALENT PROTECTEUR
- Schützende Mehrzweck-Pedana
- PEDANA PROTECTORA MULTIUSOS



MASTER 12

77177	90 x 50 cm
77178	90 x 100 cm

per AUTO, SUV, FURGONI, CAMION, CASA E TEMPO LIBERO

PEDANA MULTIUSO PER
 BAULE AUTO, CASA E TEMPO
 LIBERO.

LAVABILE
 IMPERMEABILE
 INDISTRUTTIBILE
 ANTISCIVOLO.

MULTI PURPOSE TRAY.
 FOR CAR, HOME AND HOBBIES.
 FULLY WASHABLE
 WATER PROOF
 LONG LASTING
 ANTI SLIP.



RUG PROTECTIVE

16455

- PEDANA MULTIUSO PER BAULE AUTO. IMPERMEABILE
- MULTI PURPOSE TRAY FOR CAR. WATER PROOF
- BAC MULTIUSAGE POUR AUTO. IMPERMEABLE
- Universal Schale für Autokofferraum. Wasserundurchlässig
- BASE MULTI-USO PARA AUTO. IMPERMEABLE



IDEALE
PER OGNI STAGIONE
FOR ALL SEASONS
PEDANA SAGOMABILE
SHAPEABLE TRAY



MASTER 6

16455	82 x 119 cm
--------------	-------------

expo da terra
Art.16456

PEDANA MULTIUSO

16451-16452-16453-16454

- PEDANA MULTIUSO PER BAULE AUTO. IMPERMEABILE
- MULTI PURPOSE TRAY FOR CAR. WATER PROOF
- BAC MULTIUSAGE POUR AUTO. IMPERMEABLE
- Universal Schale für Autokofferraum. Wasserundurchlässig
- BASE MULTI-USO PARA AUTO. IMPERMEABLE



MASTER 20

16451	size 1	90x50 cm
16452	size 2	90x70 cm
16453	size 3	90x85 cm
16454	size 4	90x100 cm

ESPOSITORE 28 PEDANE

16450

- ESPOSITORE 28 PZ. PEDANE MULTIUSO BAULE
- DISPLAY BOX OF 28 PZ. MULTIPURPOSE
- PRÉSENTOIR 28 PCS. DE TAPIS MULTI-USAGES POUR COFFRE
- 28 St. Mehrzweck-Displayboxen für Kofferraum
- EXPOSITOR 28 PZ. BANDEJA MULTIUSO PARA MALETERO

MASTER 1

16450	display 28 pcs
--------------	----------------



expo da terra
Art.16450
contiene:

16451	7 PZ
16452	7 PZ
16453	7 PZ
16454	7 PZ

PEDANA MULTIUSO Tabella di applicazione - Application guide



MODELLO/MODEL	90 x 50 cm	90 x 70 cm	90 x 85 cm	100 x 90 cm
ALFA ROMEO	Brera - GTV - Spider	145 - 146 - 147 - GT - Mito - Giulia	159 - Giulietta	155 - 156 - 159 sw - 164 - 166 - Stelvio
AUDI	A1 - A2 - 80/90 - TT	A3 - A3 Sedan - Q2	A7	A4 - A5 - A6 - A8 - A4 Allroad - Q3 - Q5 - Q7 - A4 sw - A6 sw - A6 Allroad
BMW	Serie 1 - Z4 - Z8	Serie 2 Active Tourer - Serie 3	Serie 4 - X1	Serie 3 sw - Serie 5 - Serie 6 - Serie 7 - X3 - X5 - X6
CHEVROLET	Aveo - Kalos - Matiz - Lacetti - Spark - Trax	Lanos - Nubira - Tacuma - Volt	Lenza - Nexia	Captiva - Cruze - Epica - Espero - Evanda - Malibu - Nubira sw - Orlando - Tahoe - TrailBlazer
CHRYSLER	Crossfire - Voyager/Gran Voyager 7 posti	PT Cruiser - Sebring	300 M	300 C - 300C Touring - Voyager/Gran Voyager 5 posti
CITROEN	Ax - CZero - C1 - C2 - C3 - C8 7 posti - Saxo	C3 Picasso - C4 - Xsara	Berlingo - C4 Picasso - Zx	Bx - C5 - C6 - C8 5 posti - C Crosser - Evasion - Nemo - Xantia - Xm - Xsara Picasso
DACIA	-	Sandero - Sandero Stepway	-	Dokker - Duster - Lodgy - Logan - Logan MCV
DAIHATSU	Copen - Materia - Sirion - Trevis	Applause - Cuore - Move - Terios	Charade - Rocky	Y.r.v. - Feroza
DODGE	-	Avenger	Caliber	Journey - Nitro
DR	DR1 - DR2	-	-	City Cross - DR5
DS	DS3	-	DS4 - DS5	-
FIAT	500 - 500L - 500 Living - 600 - Barchetta - Cinquecento - Multipla - Panda - Punto 1a serie - Uno - Ulysse 7 posti - Qubo	500X - Bravo 95 - Coupè - Idea - Tipo - Punto 2a serie - Grande Punto - Bravo 07 - Croma 05	Brava - Doblo 00 - Sedici - Stilo	Albea - Croma 85 - Fiorino - Freemont - Marea - Doblo 10 - Palio - Stilo sw - Scudo - Tempra - Ulysse Sposti - Tipo 15
FORD	B Max - Ka - Galaxy 7 posti - S Max 7 posti - Fiesta 17	EcoSport - Fiesta - Focus - C Max - Fusion - Ka+	Escort - Kuga	Escort sw - Focus sw - Galaxy 5 posti - Maverick - Mondeo - Ranger - S Max 5 posti - Tourneo Courier - Mondeo sw - Edge
GREAT WALL	-	-	-	Hover - Voleex - H6
HONDA	S2000	Accord - Civic - Concerto - Jazz	Insight - Logo - Prelude - Stream - Jazz 14 - HR-V 14 - CR-V 12	Accord Sw - CR-V - FR-V - HR-V - Legend
HYUNDAI	Atos - Getz - i10 - Matrix	Coupe - Elantra - i20 - i30 - iX20 - Lantra - Trajet - Veloster	Accent - Genesis - iX35 - Sonata - Tucson	Gallop - i40 - Santa Fe - Terracan - Tucson - Ioniq
INFINITI	-	Q50 - QX50 - Q60	G - Q70 - QX70 - M	EX - FX
ISUZU	-	-	-	DMax
JAGUAR	-	Xj - Xk	Xe - Xf	S type - XF Sportbrake - X type - F Pace
JEEP	-	Renegade - Compass 17	Compass - Cherokee - Patriot - Wrangler	Commander - Gran Cherokee
KIA	Picanto - Soul - Venga - Rio 17	Pride - Sephia - Shuma - Rio - Optima - Stonic	Carens - Cee'd - Pro Cee'd - Sportage 16	Carnival - Cee'd Sw - Cerato - Rio Sw - Magentis - Opirus - Sorento - Sportage - Niro
LADA	-	Serie 100	Niva	1207 - 307 - Samara
LANCIA	Phedra 7 posti - Y - Y10 - Ypsilon - Z 7 posti	Dedra - Delta - Musa	-	Dedra sw - K - Lybra - Phedra 5 posti - Thema - Thesis - Voyager - Z 5 posti - Lybra sw - Thema sw
LAND ROVER	-	Defender - Freelander	-	Discovery - Freelander II - Range Rover - Evoque - Discovery Sport
LEXUS	SC	IS - GS - NX	CT	IS sw - LS - RX
MAZDA	2 - MX 5 - RX 8	121 - 626	323 - CX 5 - CX 7 - Demio - MPV - Premancancy - 3	B2500 - 5 - 6 - 6 sw - Tribute
MERCEDES	Classe A - SI - SIK - S1r	Classe C coupè - Cl - Cla - Clc - Clk - Cis - 200 - 300 (W124) - Vaneo - Gla - 300Te	C berlina - E berlina - Classe R - S 280 - 600 (W140) - Glk - Classe B	C sw - E sw - G - M - S - Te 200 - 300
MG	ZR - TF	ZS - ZT	-	ZT sw
MINI	Mini	Mini sw	-	-
MITSUBISHI	I-miev - Space Runner - Space Wagon - Space Star 16	Carisma - Colt - Lancer - Pajero 3p	ASX - Grandis - Space Star - Outlander	L200 - Lancer SW - Pajero 5p
NISSAN	Almera 3p - Cube - Micra - Note - Pixo - Terrano 2 - 350Z - 370Z	Juke - Leaf - Terrano - King Cab - Primera 5p - Micra 17	Almera 5p - Sunny - Xtrail	Evalia - Murano - Pathfinder - Patrol - Primera sw - Qashqai - Serena - Xtrail 17
OPEL	Adam - Agila - Combo - Corsa - Mokka - Mokka X - Tigra - Karl - Crossland X	Ampera - Meriva - Zafira	Astra - Calibra	Antara - Astra sw - Frontera - Insigna - Signum - Vectra - Zafira 05 - Zafira Tourer - Insigna sw - Astra 15 - Grandland X
PEUGEOT	106 - 107 - 205 - 806 7 posti - 807 7 posti - 1007 - iOn - RCZ	206 - 207 - 208 - 306 - 307 - 2008	308 - 505 - 3008 - 5008 - Ranch	306 sw - 309 - 405 - 406 - 407 - 508 - 605 - 607 - 806 5 posti - 807 5 posti - 4007 - Bipper - Partner
RENAULT	Clio - Espace 7 posti - Modus - Super 5 - Twingo - Zoe	Captur - Fluence - Megane - Megane Coupè - Trafic - Scenic 17 - Grand Scenic 17	Kangoo - R19 - Scenic - Kadjar	Espace 5 posti - Koleos - Laguna - R21 - Safrane - Vel Satis - Megane Scenic - Talisman - Talisman sw
ROVER	100 - 25	S.200	S.600 - S.800 - Streetwise	75 Tourer - S.400
SAAB	-	-	-	Serie 900 - Serie 9000 - Serie 9-3 - Serie 9-5 - Serie 9-7X
SEAT	Alhambra 7 posti - Arosa - Inca - Mii - Marbella	Ateca - Altea - Leon - Ibiza	-	Alhambra 5 posti - Cordoba - Exeo - Toledo
SKODA	Citigo - Favorit	Fabia - Felicia	Rapid - Yeti	Felicia sw - Forman - Octavia - Roomster - Superb - Kodiaq
SMART	Forfour	-	-	-
SSANGYONG	-	-	Action	Korando - Kyron - Rexton - Rodius
SUBARU	Justy	Impreza - WRX - Trezia	Legacy - Impreza XV	B9 Tribeca - Forester - Impreza sw - Legacy sw - Outback
SUZUKI	Alto - Baleno 16 - Celerio - Ignis - Splash - Swift - Wagon R+	Kizashi - Gran Vitara - Liana - S-Cross	Jimny - SX4	Baleno
TATA	Indica - Vista	-	-	Aria - Indigo - Safari
TOYOTA	Avensis Verso - Aygo - Celica - iQ - MR2 - Yaris - Yaris Verso	Auris - Avensis 4p - Carina - Rav 4 - Verso S - Picnic - Prius - CH-R	Corolla - Corolla Verso	Auris sw - Avensis sw - Hi Lux - Land Cruiser - Lite Ace - Lx - Pj70 - Pj73 - Kzj 70 - Previa - Runner - Urban Cruiser - Verso
VOLKSWAGEN	Fox - Lupo - Maggiolino - Sharan 7 posti - Upl - Polo 17	Eos - Polo - Scirocco - Golf Plus - T-Roc	Golf - New beetle - Tiguan - Touran	Bora - CC - Caddy - Golf V - Golf VI - Golf Variant - Jetta - Passat - Phaeton - Polo Variant - Sharan 5 posti - Touran - Touareg - Vento - Tiguan 16
VOLVO	-	C30 - C70	-	440 / 460 - 850 - 940 - 960 - S40 - V40 - V50 - S60 - V60 - V70 - S80 - XC60 - XC70 - XC90

TAPPETINO

77117

- TAPPETINO ANTISCIVOLO PER CRUSCOTTO
- NO SLIP DASHBOARD MAT
- TAPIS ANTIDERAPANT POUR TABLEAU DE BORD
- Rutschfeste Matte für Armaturenbrett
- ALFOMBRILLA PORTA-OBJETOS ANTIDESLIZANTE



MASTER 240 INNER 24

FERMA TUTTO!

iPhone, iPod, telefoni cellulari, chiavi, monete, occhiali, penne, ecc... da oggi resteranno al loro posto in tutta sicurezza.

GOOD YEAR



TAPPETINO PORTAOGGETTI

16290

COMODINO

- TAPPETINO DA CRUSCOTTO IN GOMMA
- NON-SLIP DASHBOARD MAT
- TAPIS ANTIDERAPANT POUR TABLEAU DE BORD
- Rutschfeste Matte für Armaturenbrett
- ALFOMBRILLA PORTA-OBJETOS ANTIDESLIZANTE



MASTER 25 INNER 250

16290

IN BUSTA - PVC BAG

TAPPETINO PORTAOGGETTI

16273

ANTISCIVOLO

- TAPPETINO DA CRUSCOTTO IN GOMMA
- NON-SLIP DASHBOARD MAT
- TAPIS ANTIDERAPANT POUR TABLEAU DE BORD
- Rutschfeste Matte für Armaturenbrett
- ALFOMBRILLA PORTA-OBJETOS ANTIDESLIZANTE



MASTER 100 INNER 25

16273

in busta

pvc bag

TRUCKER TABLE

16461

- TAVOLO PORTAOGGETTI REGOLABILE 43 X 35 CM
- SMALL TABLE FOR OBJECTS 43 X 35 CM
- TABLETTE PORTE OBJETS 43 X 35 CM
- Objekträgerertisch 43 x 35 cm
- MESITA PORTAOBJETOS 43 X 35 CM



IDEALE PER FURGONI CAMPER - CAMION



REGOLABILE
ADJUSTABLE

MASTER 10

16461

43 x 35 cm

MAGIC

16266

- PORTACENERE IN PLASTICA A BARATTOLO
- CAN SHAPED ASH TRAY IN PLASTIC
- CENDRIER EN PLASTIQUE EN FORME DE POT
- Plastikaschenbecher in Dosenform
- CENICERO DE PLÁSTICO TIPO FRASCO



Fissaggio con calamita o biadesivo
Or i adhesive tape fixing
Ø 6 cm



MASTER 96 INNER 12

LIGHT

16267

- PORTACENERE IN PLASTICA A BARATTOLO
- CAN SHAPED ASH TRAY IN PLASTIC
- CENDRIER EN PLASTIQUE EN FORME DE POT
- Plastikaschenbecher in Dosenform
- CENICERO DE PLÁSTICO TIPO FRASCO



Fissaggio alla bocchetta
di aerazione
Fitting to the air vents

Ø 6 cm

Funzionante a pile 4 LR44 INCLUDE
Works with battery 4 LR44 INCLUDED

MASTER 96 INNER 12



Illuminazione a led blu all'apertura del coperchio
Blue led light at open cap



MEMO NOTES

16037

- PORTANOTES CON BIRO E MATITA. FISSAGGIO CON CLIP
- NOTES HOLDER WITH PEN AND PENCIL. FIXING WITH CLIP
- PORTE BLOC NOTES AVEC STYLO ET CRAYON. FIXAGE AVEC CLIP
- Auto-Notizbuch mit Kugelschreiber und Stift. Befestigung mit Klipp
- PORTANOTAS CON PÉNDOLA Y LÁPIZ. FIJADO CON CLIP



MASTER 100 INNER 25

ADESIVI OMOLOGATI

18400

- 2 PZ. ADESIVI PRINCIPIANTE OMOLOGATI
- 2 PCS. HOMOLOGATED BEGINNER DRIVER STICKERS
- 2 PCS. ADHÉSIFS DÉBUTANT HOMOLOGUÉS
- 2 Stk. Zugelassener anfänger + aufkleber
- 2 PZ. ADHESIVO PRINCIPIANTE HOMOLOGADO



MASTER 10



DUET

16353

- PORTA ASSICURAZIONE + DISCO ORARIO
- INSURANCE HOLDER + PARK. DISK
- PORTE-ASSURANCE + DISQUE HORAIRE
- Versicherungskupon + Parkscheibehalter
- PORTA SEGURO + DISCO HORARIO



MASTER 120 INNER 24

PORTA ASSICURAZIONE

16354

- PORTA ASSICURAZIONE + DISCO ORARIO MASTER 500 INNER 50
- INSURANCE HOLDER + PARK. DISK
- PORTE-ASSURANCE + DISQUE HORAIRE
- Versicherungskupon + Parkscheibehalter
- PORTA SEGURO + DISCO HORARIO



DISCO ORARIO

16360

- DISCO ORARIO RIGIDO SINGOLO
- PARKING TIMER
- DISQUE HORAIRE RIGIDE
- Einzelne Hart-Parkscheibe
- DISCO HORARIO RIGIDO INDIVIDUAL



MASTER 600 INNER 25

CARTA CARBURANTE

36030

- CARTA CARBURANTE 12 MESI
- 12 MONTHS FUEL SHEETS
- CARTE CARBURANT 12 MOIS
- Tankbelege für 12 monate
- TARJETA CARBURANTE 12 MESES



CARTA CARBURANTE 12 MESI



MASTER 120 INNER 60

JUNIOR

16062

SCALA DI LETTURA MEASUREMENT RANGE **-50°C/+50°C**

- TERMOMETRO DIGITALE IN/OUT 12V, BATTERIA INCLUSA
- IN/OUT DIGITAL THERMOMETER WITH BATTERY
- THERMOMÈTRE DIGITAL IN/OUT 12V, BATTERIE INCLUSE
- Digitalthermometer in/out 12v, inkl. Batterie
- TERMOMETRO DIGITAL IN/OUT 12V, BATERIA INCLUIDA



MASTER 100 INNER 25

CLOCK NEW

16047

- OROLOGIO DIGITALE AL QUARZO
- QUARTZ CLOCK WITH BATTERY
- MONTRE DIGITALE, BATTERIE INCLUSE
- Quarzuhr, inkl. Batterie
- RELOJ A CUARZO, BATERIA INCLUIDA



MASTER 200 INNER 25

RALLY

16112

- INCLINOMETRO 12V ILLUMINATO
- 12V LAND METER
- INCLINOMÈTRE 12V
- Neigungsmesser 12V
- INCLINOMETRO 12V



MASTER 48 INNER 16

EDGE

77050

FISSAGGIO CON VENTOSA
PER APPARECCHI
FINO A 110 mm

FIXING WITH SUCTION CUP
FOR DEVICES UP TO 110 mm

MASTER 48 INNER 12

Porta Telefono e Porta Navigatore Small
con clip a molla (apertura max 11 cm)
Rotazione 360°
Ventosa con pomello sottovuoto
Ghiera di tensione a vite

Phone and Small GPS Clip Holder
(max. width 11cm)
360° Rotation
Suction cup with vacuum knob
Friction Sleeve



100% universale
per tutti i telefoni
smartphone-tablet
iPhone-iPad



Rotazione 360°
360° Rotation

EDGE ULTRA

77051

FISSAGGIO CON VENTOSA
PER APPARECCHI
FINO A 210 mm

FIXING WITH SUCTION CUP
FOR DEVICES UP TO 210 mm

MASTER 48 INNER 12

Porta ipad/tablet 11" e Navigatore
XL a clip (apertura max 21 cm)
Massima regolazione
Ventosa con clip sottovuoto
Pomelli di tensione a vite

Ipad/tablet and XL size GPS Clip
Holder (max. width 21cm).
Extended Rotation
Suction cup with vacuum clip.
Friction knobs



100% universale
per tutti i telefoni
smartphone-tablet
iPhone-iPad



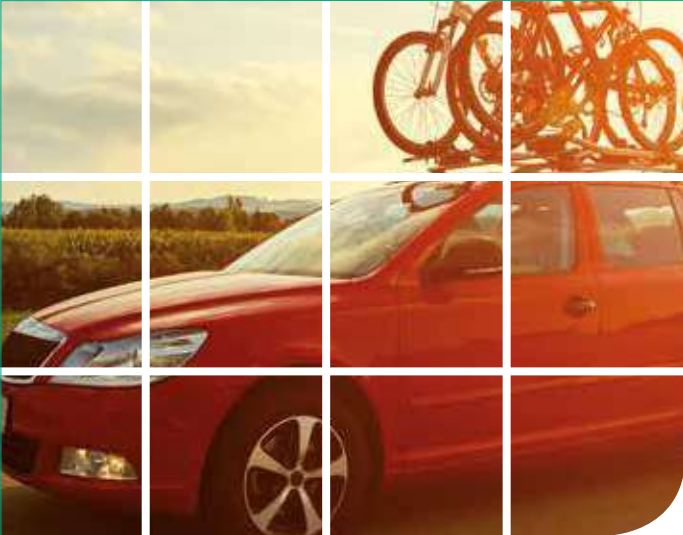

PORTAGGIO

CARRYING SYSTEMS

SUPPORTO VENDITA LINEA PORTAGGIO



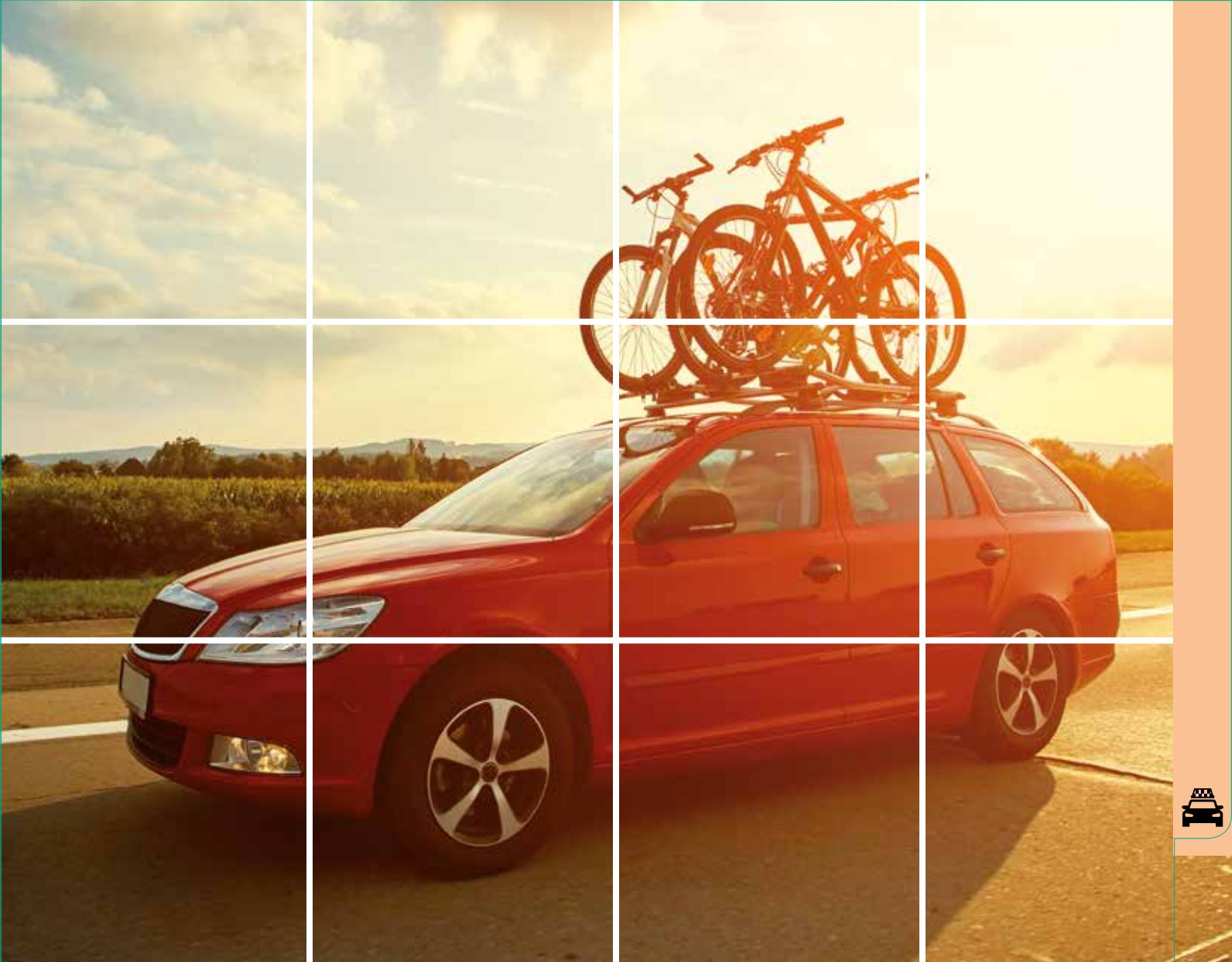

PORTAGGIO

CARRYING SYSTEMS

BARRE PORTATUTTO GOODYEAR	pag 234
PORTABICI	pag 236
PORTABICI-RETE BAGAGLI-ROOMY BAULE	pag 237
BOX AUTO	pag 238



FROZEN

77200 - 77201

- COPPIA BARRE IN ALLUMINIO PER AUTO CON RAILINGS
- LUGGAGE RACKS FOR VEHICLES WITH LONGITUDINAL MOUNTS
- BARRES DE TOIT POUR VOITURES AVEC BARRES D'ORIGINE LONGITUDINALES
- Relingträger nur für Fahrzeuge mit dachreling geeignet
- BARRAS PORTADO PARA BARRAS LONGITUDINALES DE ORIGEN

77200	argento - silver	122 cm
77201	argento - silver	135 cm



MAX 90 KG



ALLUMINIO
ALUMINIUM



77200



77201



DISPOSITIVO ANTIFURTO POSIZIONATO SULL' ATTACCO DELLA BARRA
 SUPPORTO IDEALE PER PORTABICICLETTA, PORTASCI, PORTABAGAGLI
 L' ATTACCO PARTICOLARE NE PERMETTE
 IL MONTAGGIO SULLA MAGGIOR PARTE
 DELLE VETTURE CON MANIGLIONI

ANTITHEFT DEVICE FITTED
 ON THE LUGGAGE BARS
 THE IDEAL SUPPORT FOR FITTING
 OF BICYCLE-RACKS,
 SKI-RACKS, LUGGAGE-RACKS
 THE PECULIAR FASTER ALLOWS ITS
 FITTING TO
 THE MOST POPULAR VEHICLES
 WITH RAILS

MASTER 4

BARRE CARGO



COPPIA BARRE PORTATUTTO PER AUTO CON BARRE LONGITUDINALI.
 UNIVERSAL ROOF RACKS FOR VEHICLES WITH LONGITUDINAL MOUNTS.
 COMPATIBILE CON LA MAGGIOR PARTE DEI VEICOLI DOTATI DI MANCORRENTI
 LONGITUDINALI AL TETTO.

77220-77221

- COPPIA DI BARRE PORTATUTTO IN ACCIAIO
- 2 CAR ROOF BARS
- 2 BARRES DE TOIT DE VOITURE
- 2 Autodachstangen
- 2 BARRAS DE TECHO PARA COCHES

FACILE MONTAGGIO CON UNA SOLA CHIAVE INGLESE.
 SIMPLE ASSEMBLY WITH JUST ONE WRENCH.

77220	nero	120 cm
77221	nero	135 cm



MASTER 4

BARRE CARGO LOCK



COPPIA BARRE PORTATUTTO PER AUTO CON BARRE LONGITUDINALI.
 UNIVERSAL ROOF RACKS FOR VEHICLES WITH LONGITUDINAL MOUNTS.
 COMPATIBILE CON LA MAGGIOR PARTE DEI VEICOLI DOTATI DI MANCORRENTI
 LONGITUDINALI AL TETTO.

77222-77223

- COPPIA DI BARRE PORTATUTTO IN ACCIAIO CON CHIUSURA ANTIFURTO
- 2 CAR ROOF BARS WITH ANTITHEFT LOCK
- 2 BARRES DE TOIT AVEC ANTITHEFT LOCK
- 2 auto-Dachstangen mit Antitheft Lock
- 2 BARRAS DE TECHO PARA COCHE CON BLOQUEO ANTIRROBO

PER AUTO CON MANCORRENTI LONGITUDINALI
 FOR CAR WITH ROOF RAILS

SEZIONE RETTANGOLARE TRADIZIONALE CON SUPERFICIE D'APPOGGIO PIANA
 FLAT SURFACE AND RECTANGULAR SECTION

77222	nero	120 cm
77223	nero	135 cm



CHIUSURA
 DI SICUREZZA
 A CHIAVE

ANTITHEFT
 LOCK



MASTER 4



PORTABICI VOYAGER 2 BICI

77224

- PORTABICI VOYAGER 2 BICI
- VOYAGER 2 BICYCLES CARRIER

- PORTE-VÉLOS FIXATION UNIVERSELLE
- Universal-Fahrradträger
- PORTABICICLETAS CONEXIÓN UNIVERSAL

Adattabile alla maggior parte dei veicoli grazie ai bracci ed alle cinghie completamente regolabili (non compatibile con portelloni dotati di gomma di scorta a sbalzo). Facile da montare, leggero, dotato di morbide protezioni antigraffio per il veicolo e le biciclette.

Fully adjustable to fit most types of vehicles (not suitable for vehicles with back mounted spare wheel). Easy to install, lightweight, with protective rubber absorbers.



Salvaspazio e ripiegabile

Folds flat for easy storage



Dim. Ca: 76x52x10cm

MASTER 4



PORTABICI VOYAGER 3 BICI

77225

- PORTABICI VOYAGER 3 BICI
- VOYAGER 3 BICYCLES CARRIER

- PORTE-VÉLOS FIXATION UNIVERSELLE
- Universal-Fahrradträger
- PORTABICICLETAS CONEXIÓN UNIVERSAL

Adattabile alla maggior parte dei veicoli grazie ai bracci ed alle cinghie completamente regolabili (non compatibile con portelloni dotati di gomma di scorta a sbalzo). Facile da montare, leggero, dotato di morbide protezioni antigraffio per il veicolo e le biciclette.

Fully adjustable to fit most types of vehicles (not suitable for vehicles with back mounted spare wheel). Easy to install, lightweight, with protective rubber absorbers.

Salvaspazio e ripiegabile

Folds flat for easy storage

Dotato di attacchi a sgancio rapido per 3 biciclette



Equipped with quick release bike hooks

Dim. Ca: 76x52x10cm

MASTER 4



PORTABICICLETTA TOP ROOF

18232

- PORTABICICLETTA ATTACCO UNIVERSALE
- UNIVERSAL FITTING CYCLE RACK
- PORTE-VÉLOS FIXATION UNIVERSELLE
- Universal-Fahrradträger
- PORTABICICLETTAS CONEXIÓN UNIVERSAL

PER BARRE CHE MISURANO NON PIÙ DI 48X40MM
DI FACILE MONTAGGIO ADATTO PER BICICLETTE
CON TELAI CILINDRICI. BRACCIA DI BLOCCAGGIO
CON PROTEZIONI PLASTICHE

CAN BE FITTED ON ROOF RACKS MEASURING NOT MORE THAN
48X40MM EASY TO ASSEMBLE SUITABLE FOR BYCICLES WITH CYLINDRICAL
FRAMES BEARING BAR FASTENINGS PROTECTED BY PLASTIC COVERS



ACCIAIO - STEEL

MASTER 6

RETE BAGAGLI

18229

- RETE PER BAGAGLI MISURA 72 X 82 CM. ESTENSIBILE 40%
- BAGGAGE NET SIZE 72 X 82 CM. EXTENSIBLE 40%
- DIMENSION DU FILET DU COFFRE À BAGAGES 72 X 82 CM. EXTENSIBLE 40%
- Netz für Gepäck 72 x 82 cm. Dehnbar 40%
- CUBRE-EQUIPAJES TAMAÑO 72 X 82 CM. EXTENSIBLE 40%



72x82cm

8 GANCI-8 HOOKS

MASTER 24



ROOMY BAULE

18387

- BAULE IMPERMEABILE CON BORDO RINFORZATO E CERNIERA
- WATERPROOF LUGGAGE PROTECTION BAG WITH STRENGTHENED HEMAND ZIP FASTENER
- PROTEGE-BAGAGES IMPERMEABLE AVEC BORD RENFORCE ET FERMETURE ECLAIR
- Wasserabweisende gepäckabdeckung mit verstärkter Randbordure und Reissverschluss
- CUBRE-EQUIPAJES IMPERMEABLE CON BORDE REFORZADO Y CREMALLERA



**IMPERMEABILE
WATERPROOF**

96x66x60cm



**MATERIALE CORDURA IMPERMEABILE
WATERPROOF CORDURA MATERIAL**

MASTER 10



CARGOBOX MAMMUTH

77205

- BOX AUTO IN MATERIALE ANTIURTO CON CHIUSURA CENTRALIZZATA E FISSAGGIO INTERNO
- CAR BOX MADE OF SHOCKPROOF MATERIAL WITH CENTRAL LOCKING AND INTERNAL FASTENER
- BOX POUR VOITURE EN MATERIEL ANTICHOC AVEC FERMETURE CENTRALE ET ABLOCAGE INTERIEUR
- Autobox aus Stossfestmaterial mit Zentralschliessen und innere Befestigung
- BOX PARA LA COQUE EN MATERIAL CONTRA GOLPES CON CIERRE CENTRALIZADA Y FIJACIÓN INTERIOR

77205 | nero - black | 320 lt



Italia
DIN 75302:1991
Z1A 14 04 87737 001

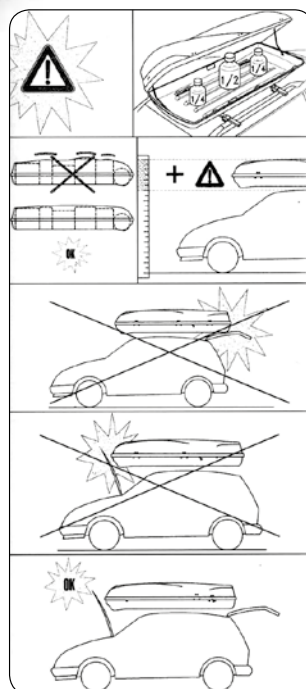
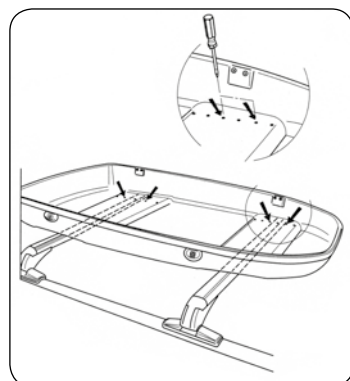

Dati tecnici Technical data	77205
Lunghezza Length	1300 mm
Larghezza Width	790 mm
Altezza Height	260 mm
Capacità Capacity	320 lt
Colore Color	Nero/Black
Peso netto Net weight	12 kg.
Peso lordo Gross weight	14,5 kg.
Carico max Max. load	55 kg.
Materiale Material	P.P. UV PROTECTED
Apertura Opening	Laterale Dx Right side
Sollevatore a molla Spring jacks	Si Yes
Chiusura centralizzata Centralized lock	2 punti 2 points
Fissaggio interno Fixing straps	Si Yes
Volume imballo Package volume	0,39 m ³
Fissaggio esterno External fixing kit	

MASTER 1

CARGOBOX MAMMUTH XL

77206

- BOX AUTO IN MATERIALE ANTIURTO CON CHIUSURA CENTRALIZZATA E FISSAGGIO INTERNO
- CAR BOX MADE OF SHOCKPROOF MATERIAL WITH CENTRAL LOCKING AND INTERNAL FASTENER
- BOX POUR VOITURE EN MATERIEL ANTICHOC AVEC FERMETURE CENTRALE ET ABLOCAGE INTERIEUR
- Autobox aus Stossfestmaterial mit Zentralschliessen und innere Befestigung
- BOX PARA LA COQUE EN MATERIAL CONTRA GOLPES CON CIERRE CENTRALIZADA Y FIJACIÓN INTERIOR

77206 | nero - black | 480 lt

GOODYEAR



Italia
DIN 75302:1991
Z1A 14 04 87737 001

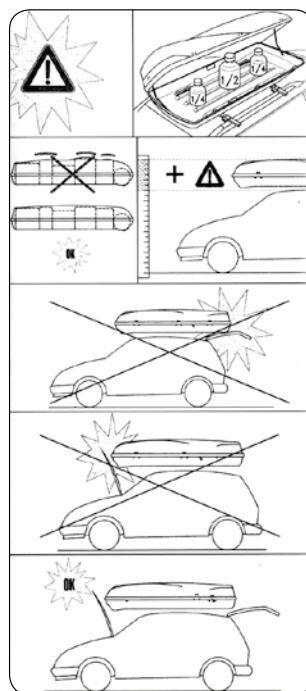
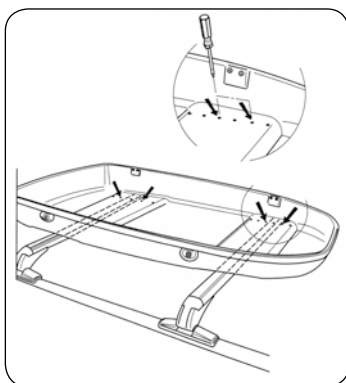

Dati tecnici Technical data	77206
Lunghezza Length	2005 mm
Larghezza Width	790 mm
Altezza Height	380 mm
Capacità Capacity	480 lt
Colore Color	Nero/Black
Peso netto Net weight	21,6 kg
Peso lordo Gross weight	25 kg.
Carico max Max. load	75 kg.
Materiale Material	P.P. UV PROTECTED
Apertura Opening	Laterale Dx Right side
Sollevatore a molla Spring jacks	Si Yes
Chiusura centralizzata Centralized lock	2 punti 2 points
Fissaggio interno Fixing straps	Si Yes
Volume imballo Package volume	0,48 m ³
Fissaggio esterno External fixing kit	

MASTER 1



ESTERNI

EXTERIOR ACCESSORIES

SUPPORTO VENDITA ACCESSORI ESTERNI

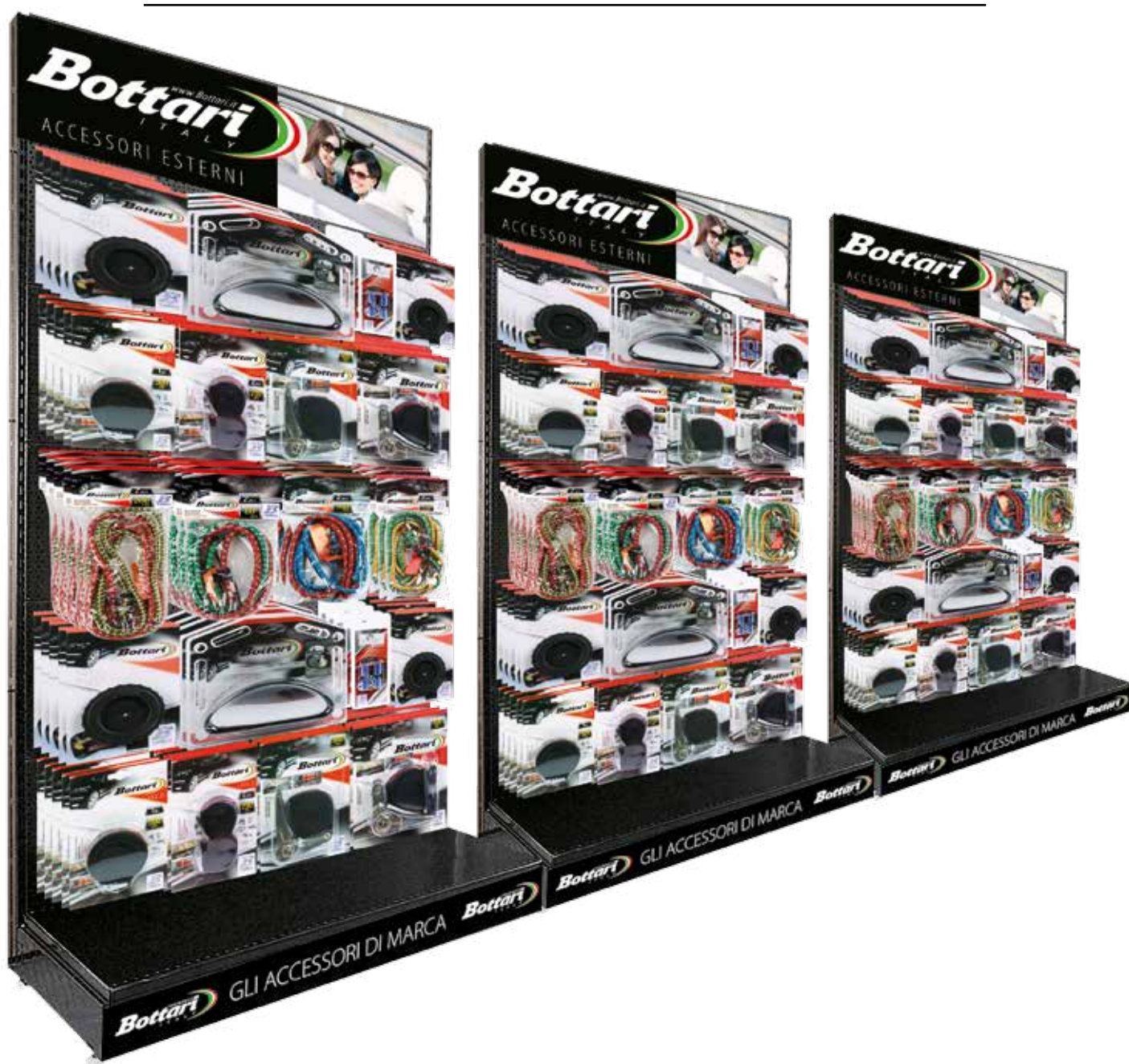



ACCESSORI ESTERNI

EXTERIOR ACCESSORIES

SALVAPORTA - SALVAURTI	pag 242
TAPPI BENZINA - SPECCHIETTO AUSILIARIO	pag 244
PORTATARGA CON RETROCAMERA	
ADESIVI VELOCITÀ - CORDE ELASTICHE	pag 245
CINGHIE DI FISSAGGIO	pag 246



STILEX SALVAPORTA

18135

- 4 PZ. SALVAPORTA ADESIVI ANTIGRAFFIO (2 ANTERIORI+2 POSTERIORI)
- 4 PCS. DOOR GUARDS WITH SPECIAL ADHESIVE (2 FRONT + 2 REAR)
- PROTÈGE PORTIÈRES 4 PCS. AVEC ADHÉSIF SPÉCIAL
- 4 stk. Türschutzleisten, mit Spezialkleber
- SALVAPUERTAS 4 PZ. CON ADHESIVO ESPECIAL



MASTER 100 INNER 10

SOFT SALVAPORTA 65CM

18005 - 18006

- SALVAPORTA 2 PZ. 65 CM AD INCASTRO
- 2 PCS. SLOT DOOR GUARDS. LENGHT 65 CM
- PROTÈGE PORTIÈRES 2 PCS. 65 CM À ENCASTREMENT
- 2 Stk. Aufsteckbare türschutzleisten, 65 cm
- SALVAPUERTAS 2 PZ. 65 CM CON ENCAJE

18005	nero	black
18006	trasparente	transparent

65 cm

MASTER 120 INNER 24



TRASPARENTE



SALVAPORTA CATARIFRANGENTI PAGODA

18009 - 01103

- COPPIA SALVAPORTA CON CATARIFRANGENTI
- COUPLE OF DOOR GUARDS WITH REFLECTORS
- LOT DE DEUX PROTÈGES PORTIÈRES AVEC CATADIOPTRE
- Ein Paar Türschutzleisten mit Rückstrahlern
- PAR SALVAPUERTAS CON CATADIOPTRICO

13,5 cm

2 pz

18009	in blister	MASTER 120	INNER 12
01103	in busta trasparente	MASTER 200	INNER 50



R.CHROME

15506

- SALVAPORTA AD INCASTRO
- SLOT DOOR GUARDS
- PROTÈGE PORTIÈRES À ENCASTREMENT
- Aufsteckbare Türschutzleisten
- SALVAPUERTAS CON ENCAJE

LARGHEZZA/WIDTH 1 cm

2 PCS. x 87 cm - 2 PCS. x 67 cm

MASTER 100 INNER 10

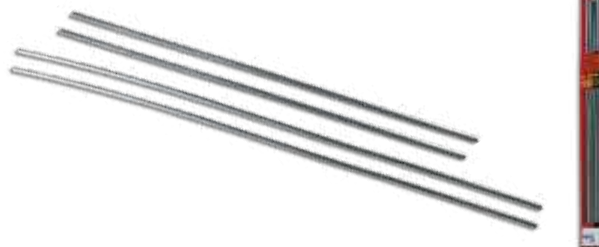

KIT 4 PEZZI ANTERIORE - POSTERIORE

R.SHAPE

15521-15522-15524

- SALVAPORTA ADESIVI
- DOOR GUARDS WITH ADHESIVE
- PROTÈGE PORTIÈRES AVEC ADHÉSIF
- Türschutzleisten mit kleber
- SALVAPUERTAS CON ADHESIVO

LARGHEZZA/WIDTH 1,3 cm

2 PCS. x 87 cm - 2 PCS. x 67 cm

MASTER 100 INNER 10



15521	cromato	chromed	4pcs
15522	carbonio	carbon	4pcs
15524	grigio	grey	4pcs



KIT 4 PEZZI ANTERIORE - POSTERIORE



TAPPI BENZINA

18050 - 18051 - 18052

- TAPPO BENZINA UNIVERSALE
- UNIVERSAL FUEL CAP
- BOUCHON DE RÉSERVOIR UNIVERSEL
- Tankverschluss, universal
- TAPÓN GASOLINA UNIVERSAL

18050	flessibile
18051	universale
18052	screw

MASTER 100 INNER 50

art. 18050



art. 18051



art. 18052



**NON ADATTO PER SERBATOI
 CON IMBOCCATURA
 DI DIAMETRO PIU' LARGO DI 5 cm**

**NOT SUITABLE FOR PETROL TANK
 WITH OPENING LARGER THAN 5 cm**



BEST VIEW

18279

- SPECCHIETTO AUSILIARIO VISTA A GRANDANGOLO
- AUXILIARY SPOT MIRROR WIDE-ANGLE VIEW
- SPOT AUXILIAIRE RETROVISEUR LARGE VUE D'ANGLE
- Rückspiegelbehelf, Sicht im Weitwinkel
- ESPEJO AUXILIAR ÁNGULO MUERTO VISTA GRAN ANGULACIÓN

1 pz

MASTER 60 INNER 12



PORTATARGA CON RETROCAMERA 170°

30790

- CAM PLATE CON RETROCAMERA A COLORI CCD
- CAM-PLATE WITH CAR REAR VIEW COLOR CCD CAMERA
- CAM-PLATE RETRO-CAMERA EN COULEURS CCD
- Cam-plate Farbbildkamera zum Rückwärtsfahren Ccd
- CAM-PLATE RETRO-CÁMARA EN COLOR CCD



SPECIFICHE TECNICHE CAM-PLATE

- VIDEOCAMERA: 170°, 1/4" CCD A COLORI SHARP
- RISOLUZIONE ORIZZONTALE: 420 LINEE TV
- NUMERO PIXEL: NTSC: 510(H)X492(V) PAL: 500(H) X 582(V)
- SISTEMA TV: NTSC/PAL
- SINCRONIZZAZIONE INTERNA
- ILLUMINAZIONE DISPONIBILE: 1.0 LUX
- USCITA VIDEO: 1.0VP-P 75 OHM
- TEMPERATURA OPERATIVA: -10°C • +50°C
- ALIMENTAZIONE: 12V DC - 80MA
- PESO: 100GR
- DIMENSIONI: DIAMETRO 22MM; LUNGHEZZA 120MM
- IL PRODOTTO VIENE FORNITO CON CAVO A TENUTA STAGNA DELLA LUNGHEZZA DI 10 METRI (MINI DIN-RCA MASCHIO+12V/MASSA)

SPECIFICHE TECNICHE MONITOR LCD DA 3,5"

- MONITOR TFT LCD A COLORI
- DIMENSIONE MONITOR: 3,5"
- SISTEMA COLORE: PAL/NTSC CON COMMUTAZIONE AUTOMATICA
- IMMAGINE MIRROR O NORMALE
- LUMINOSITÀ REGOLABILE
- DUE INGRESSI VIDEO
- INGRESSO RETROCAMERA
- DIMENSIONI: 102X98X13MM



MASTER 16

70/80/100

18402 - 18403 - 18404

- ADESIVI VELOCITÀ OMOLOGATI
- HOMOLOGATED SPEED STICKERS
- ADHÉSIFS VITESSE HOMOLOGUÉS
- Zugelassener Geschwindigkeits-Aufkleber
- ADHESIVO VELOCIDAD HOMOLOGADO

18402	70 speed
18403	80 speed
18404	100 speed



MASTER 24

1 CORDA ELASTICA

01000 - 01100

- CORDA ELASTICHE CON GANCIO DI SICUREZZA Ø 8 MM
- ELASTIC STRAPS WITH SAFETY HOOK Ø 8 MM
- SANDOWS ELASTIQUES AVEC SANGLE DE SECURITÉ Ø 8 MM
- Gummiseile mit sicherheitshaken ø 8 mm
- CUERDA ELASTICA CON GANCHO DE SEGURIDAD Ø 8 MM

01000	40 cm	Ø 8 mm
01100	40 cm	Ø 8 mm

40 cm - Ø 8 mm

MASTER 200



CORDE ELASTICHE

18224 - 18225 - 18226 - 18227

- COPPIA CORDE ELASTICHE CON GANCIO DI SICUREZZA Ø 8 MM
- ELASTIC STRAPS WITH SAFETY HOOK Ø 8 MM
- SANDOWS ELASTIQUES AVEC SANGLE DE SECURITÉ Ø 8 MM
- Gummiseile mit sicherheitshaken ø 8 mm
- CUERDA ELASTICA CON GANCHO DE SEGURIDAD Ø 8 MM

18224	2 PZ	80 cm	Ø 8 mm
18225	2 PZ	100 cm	Ø 8 mm
18226	2 PZ	150 cm	Ø 8 mm
18227	2 PZ	200 cm	Ø 8 mm



MASTER 72 INNER 24



art. 18226 - 150cm

art. 18227 - 200cm



art. 18224 - 80cm

art. 18225 - 100cm

CINGHIE URSUS

18200 - 18201 - 18202 - 18205

- CINGHIA DI FISSAGGIO
- FIXING STRAP
- SANGLE À BOUCLE DE FIXAGE
- Befestigungsriemen
- CINCHA CON TENSOR

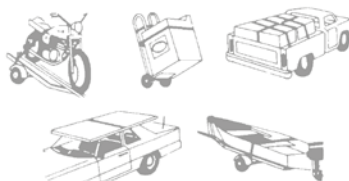

18200	URSUS	500 cm	MASTER 96	INNER 12
18201	URSUS	2 x 250 cm	MASTER 96	INNER 12
18202	URSUS	500 cm	MASTER 48	INNER 12
18205	PLUS	500 cm	MASTER 48	INNER 12

CINGHIE MASTER

18203 - 18207 - 18208

- CINGHIA DI FISSAGGIO CON CRICCHETTO
- STRAP WITH RATCHET
- SANGLE DE FIXAGE AVEC CLIQUET
- Riemen mit spann-schnalle
- CINCHA DE FIJACIÓN CON GATO

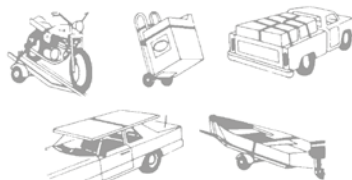

18203	500 cm	3000 Kg	MASTER 15	
18207	500 cm	2700 Kg	MASTER 16	
18208	800 cm	5000 Kg	MASTER 16	INNER 4





SOS

SOS ACCESSORIES

SUPPORTO VENDITA SOS





SOS

SOS ACCESSORIES

ACCESSORI SOS pag 250



SNOW PIT STOP

35260

- 8 FASCETTE IN NYLON AD ALTA RESISTENZA
- 8 PCS REINFORCED NYLON ZIP-TIES
- 8 FASCES DE NYLON
- 8 Stück verstärkte Nylon Zip-Ties
- 8 FASCES DE NYLON

MASTER 12

SOS SnowPitStop è il rivoluzionario sistema anti slittamento che nei casi di scarsa aderenza consente di continuare il viaggio in tutta sicurezza, con la serenità di rientrare a casa sempre e comunque. È perfetto in caso di neviccate improvvise, sul ghiaccio, od in tutti i casi di bassa aderenza o di scarsa motricità come sabbia, fango e erba umida.

SOS SnowPitStop is the revolutionary anti-skid system that allows in any situation of poor adherence to continue the journey and ensuring to return home safely. It is perfect in the event of sudden and unexpected snowfall, on ice, or in all cases of low grip or low traction as sand, mud and wet grass.



**FASCETTE
NYLON AD ALTA
RESISTENZA**

8 fascette in Nylon ad Alta Resistenza

Si installano in un batter d'occhio attorno alla ruota, senza spostare il veicolo, senza sporcarsi e senza attrezzi di alcun tipo.

Speciale disegno 3D per la massima trazione.

Si adatta a tutti i pneumatici con sezione sino a 255mm, invernali, estivi ed all season.

Pratico da tenere in auto, occupa pochissimo spazio. E' il completamento ideale del treno dei pneumatici invernali.

Facile da installare anche quando il veicolo è già "bloccato", facili da rimuovere con il coltellino in dotazione.

Si suggerisce un uso di almeno 3 unità per ruota.

Resistente alle temperature più estreme.

Pratico anche per aiutare altri automobilisti in casi di emergenza.

8pcs reinforced Nylon Zip-Ties

Simple installation around the wheel, without moving the vehicle, without getting dirt and without tools of any kind.

Special 3D design for maximum traction.

It can be installed and removed in a flash.

Suitable for all tires with width up to 255mm.

Handy to keep in your car in a small space. Ideal completion of the winter tires train.

Easy to install, even when the vehicle is already "locked", easy to remove with a simple cut with the included knife.

It is recommended to use at least 3 units per wheel.

Made with a high-quality strong nylon, resistant to extreme temperatures.

Also handy to help other motorists in emergency cases.

**SISTEMA
ANTI SLITTAMENTO**

**8
PCS**



FANGO/MUD



SABBIA/SAND



NEVE/SNOW



SNOW PIT STOP

35265

- 6 FASCETTE IN NYLON AD ALTA RESISTENZA
- 6 PCS REINFORCED NYLON ZIP-TIES
- 6 FASCES DE NYLON
- 6 Stück verstärkte Nylon Zip-Ties
- 6 FASCES DE NYLON

MASTER 12

SISTEMA ANTI SLITTAMENTO

RIUTILIZZABILE

6
PCS



EXTREME

ERBA/GRASS



FANGO/MUD



NEVE/SNOW



SABBIA/SAND



SOS SnowPitStop EXTREME è il pratico e nuovo sistema anti slittamento RIUTILIZZABILE che consente nelle situazioni di bassa aderenza di proseguire il viaggio in tutta sicurezza e con la certezza di rientrare a casa senza pericolo. Perfetto in casi di neve improvvisa, ma anche su ghiaccio, fango, erba umida o sabbia, od in tutte le situazioni di scarsa motricità. 6 fasce in Nylon Rinforzato dotate di ganci in metallo FAST CONNECTION che si installano in un batter d'occhio attorno alla ruota, senza spostare il veicolo, senza sporcarsi e senza attrezzi di alcun tipo.

Si adatta a tutti i pneumatici con sezione sino a 235mm, invernali, estivi ed all-seasons - Pratico da tenere in auto nella sua sacca in nylon impermeabile. E' il completamento ideale del treno di pneumatici invernali - Facile da installare anche quando il veicolo è già "bloccato". Facile da rimuovere con un semplice gesto - Garantisce la massima trazione grazie a speciali piastrine metalliche ad alta resistenza - Il set contiene 6 fascette per scatola (si suggerisce un uso di 3 unità per ruota) - Resistente alle temperature estreme - Pratico anche per aiutare altri automobilisti in casi di emergenza.

SOS SnowPitStop EXTREME is the practical and new REUSABLE anti-slip system that allows in every situation to continue the journey safely and to return home. Perfect in cases of sudden snow, but also on ice, mud, wet grass or sand, or in all situations of poor motricity. 6 Reinforced Nylon Straps equipped with FAST CONNECTION metal hooks, simple to fit around the wheel without moving the vehicle, without getting dirty and without any tool of any kind.

Suitable for tire sizes up to 235mm, either winter, summer and all-season tires - Comes with a waterproof nylon bag. It is the ideal completion of the winter tire train - Easy to install even when the vehicle is already "locked". Easy to remove with a simple gesture - It guarantees maximum traction thanks to special high strength metal platelets - The set contains 6 pcs (it is recommended to use 3 units per wheel) - Resistant to extreme temperatures. It is also practical to help other motorists in emergency situations.

KIT RIPARA GOMMA AUTO E MOTO

35208

- KIT RIPARA GOMMA AUTO E MOTO
- CAR & MOTO TYRE REPAIR KIT
- KIT RÉPARATION POUR MOTO ET PNEU
- Moto und Reifen Reparatursatz
- KIT DE REPARACIÓN PARA MOTO Y NEUMÁTICO



**CAR
SUV
TRUCK
SCOOTER
MOTORCYCLE**

KIT RIPARA
N°1 in Italy
and Worldwide
GOMME



IL KIT COMPLETO COMPRENDE:

- PINZA
- LAMETTA
- ATTREZZO ALESATORE PER ALLARGARE E PULIRE IL FORO
- ATTREZZO CON PUNTA A GANCIO PER INSERIRE LA STRISCE DI GOMMA
- 5 STRISCE DI RIPARAZIONE
- SOLUZIONE COLLA SENZA BENZENE
- PRATICA CUSTODIA

TYRE REPAIR KIT INCLUDES:

- PLIER
- CUTTER
- REAMER TOOL TO ENLARGE AND CLEAN THE PUNCTURE
- HOOK AND TOOL INSERT THE PLUGS
- 5 REPAIRING STRIPES
- TUBE OF GLUE WITHOUT BENZENE
- POUCH TO STORE THE FULL KIT

KIT 7 PCS

PRATICO, EFFICACE E SICURO - PRATICAL, EFFECTIVE, SAFE



MASTER 60 INNER 12

CARTELLI CARICO SPORGENTE

28050

- CARTELLI CARICO SPORGENTE DOTATO DI 4 GEMME
- PROJECTING LOAD SIGN WITH 4 REFLECTORS
- PLAQUE DE SIGNALISATION AVEC 4 CATADIOPTRES EN DOTATION
- Schild vorstehende Ladung mit 4 Katzenaugen
- PLACA CARGA SOBRESALIENTE



MASTER 10

POMPA UNIVERSALE A PEDALE

35155

- POMPA UNIVERSALE A PEDALE
- ONE CYLINDER UNIVERSAL PUMP
- POMPE DE GONFLAGE MULTI-USAGES À UN CYLINDRE
- Alles aufblasenden einzylinderpumpe
- BOMBA UNIVERSAL CON UN CILINDRO

**DOTATA DI ATTACCHI E ADATTATORI
 EQUIPPED OF ATTACKS AND ADAPTERS**

MASTER 12



SBLOCCANTE LUBRIFICANTE

35200

- SBLOCCANTE LUBRIFICANTE SPRAY
- PENETRATING LUBRICANT
- DÉGRIPPANT LUBRIFIANT
- Schraubenlöser/Schmiermittel
- AFLOJA-LUBRICA ROSCAS

250ml

MASTER 24



Rimuove viti, bulloni cerniere da ruggine e incrostazioni garantendo una futura protezione per le parti trattate.

Penetrates rust and corrosion to loosen screws, bolts and hinges, while leaving a coating for future protection.



SBLOCCANTE LUBRIFICANTE

35201

- SBLOCCANTE LUBRIFICANTE SPRAY
- PENETRATING LUBRICANT
- DÉGRIPPANT LUBRIFIANT
- Schraubenlöser/Schmiermittel
- AFLOJA-LUBRICA ROSCAS

450ml

MASTER 24



Rimuove viti, bulloni cerniere da ruggine e incrostazioni garantendo una futura protezione per le parti trattate.

Penetrates rust and corrosion to loosen screws, bolts and hinges, while leaving a coating for future protection.



GONFIA E RIPARA PNEUMATICI

35205

- GONFIA E RIPARA PNEUMATICI
- TYRE REPAIR INFLATES AND REPAIRS FOR EMERGENCIES
- GONFLE ET RÉPARE PRODUIT D'URGENCE
- Reifenfüll- und Dichtmittel Erzeugnis für Notfälle
- HINCHA Y REPARA NEUMÁTICOS PRODUCTO DE EMERGENCIA

450ml



MASTER 24



CAVI BATTERIA PROFESSIONALI

35165

- CAVI BATTERIA PROFESSIONALI
- PROFESSIONAL BOOSTER CABLE
- CABLE BATTERIE PROFESSIONNEL
- Beruflich Batterieseil
- CABLE BATERIA PROFESIONAL



200A

MASTER 24

CAVI BATTERIA PROFESSIONALI

35170

- CAVI BATTERIA PROFESSIONALI
- PROFESSIONAL BOOSTER CABLE
- CABLE BATTERIE PROFESSIONNEL
- Beruflich Batterieseil
- CABLE BATERIA PROFESIONAL



400A

MASTER 12

CARICA BATTERIA

35175

- CARICA BATTERIA 4AH
- 4A BATTERY CHARGER
- CHARGEURS DE BATTERIE 4A
- Batterieladegerate 4A
- CARGADOR DE BATERÍAS 4A

**Solo per 12 Volt
con fusibile e spina universale
protezione contro
surriscaldamento**

- CARATTERISTICHE TECNICHE:
Entrata: 230 V AC, 50 Hz, 60W.
Uscita: 12 V - 2.7 A DC
Capacità minima: 20 Ah
- CONFORME A:
EN 60335 parte 2 sezione 2.29

- TECHNICAL FEATURES:
Input: 230 V AC, 50 Hz, 60W
Output: 12 V - 2.7 A DC
Minime capacity: 20 Ah
- IN ACCORDANCE WITH:
EN 60335 part 2 section 2.29



**CONFORME ALLE ULTIME
NORMATIVE DI LEGGE
EUROPEE**

MASTER 12

MANTENITORE DI CARICA PER BATTERIE

35255

- MANTENITORE DI CARICA PER BATTERIE
- PLUG IN LEAD ACID BATTERY CHARGER
- BRANCHEMENT CHARGEUR DE BATTERIE ACIDE/PLOMB
- Ladestecker für bleibatterie
- CONECTAR EL CARGADOR BATERIA A PLOMO

Tensione in ingresso: 230V AC
Tensione in uscita 6V & 12V DC
Portata massima 500mA
Spina di uscita:
CLIP BATTERIA ROSSO E NERO

Ideale per:
• Auto • Moto • Furgoni • Camper • Barche ecc...

230V AC 6V E 12V DC



MASTER 12

CINGHIE DI FISSAGGIO

35005

- CINGHIE DI FISSAGGIO 2 X 250 CM
- COUPLE OF FIXING STRAPS
- LOT DE DEUX SANGLES À BOUCLE DE FIXAGE
- Satz Befestigungsriemen
- CINCHAS DE FIJACIÓN

2 x 250 cm

MASTER 96 INNER 12



CINGHIA DI FISSAGGIO

35010

- CINGHIA DI FISSAGGIO CON CRICCHETTO
- FIXING STRAPS
- SANGLES À BOUCLE DE FIXAGE
- Satz Befestigungsriemen
- CINCHAS DE FIJACIÓN

1 x 500 cm

MASTER 48 INNER 12



CORDE ELASTICHE

35030

- 2 CORDE ELASTICHE 2 X 80 CM
- ELASTIC STRAPS WITH SAFETY HOOK
- SANDOWS ELASTIQUES AVEC SANGLE DE SECURITÉ
- Gummiseile mit sicherheitshaken
- CUERDA ELASTICA CON GANCHO DE SEGURIDAD

2 x 80 cm

MASTER 72 INNER 24



CORDE ELASTICHE

35035

- 2 CORDE ELASTICHE 2 X 150 CM
- ELASTIC STRAPS WITH SAFETY HOOK
- SANDOWS ELASTIQUES AVEC SANGLE DE SECURITÉ
- Gummiseile mit sicherheitshaken
- CUERDA ELASTICA CON GANCHO DE SEGURIDAD

2 x 150 cm

MASTER 72 INNER 24



ETILOMETRO CON PORTACHIAVI

35055

- ETILOMETRO CON PORTACHIAVI
- ALCOHOL BREATH TESTER
- ETHYLOMETRE
- Alkoholtestgerät
- ETILÓMETRO

CARATTERISTICHE
 test alcolemico in 3 fasi
 risposta ed esito rapido
 catenella portachiavi
 utilizzate 2 pile alcaline
 AAA/um-4 da 1.5v non incluse

FEATURES
 3step alcohol test
 quick response and resume
 key chain
 use two 1.5v AAA/um-4 alkaline
 batteries not included



LUCE LED

MASTER 180 INNER 36

TRIANGOLO EMERGENZA

35190

- TRIANGOLO EMERGENZA OMOLOGATO
- EMERGENCY WARNING TRIANGLE, E HOMOLOGATED
- TRIANGLE D'URGENCE
- Pannendreieck
- TRIANGULO EMERGENCIA



OMOLOGATO

MASTER 48

KIT PRONTO SOCCORSO CON VELCRO

35180

- KIT PRONTO SOCCORSO CON VELCRO
- FIRST AID KIT FOR CARS AND TRUCKS
- KIT VALISE DE PREMIERS SECOURS
- KIT Erste-Hilfe-Koffer zugelassen
- KIT MALETÍN DE PRIMEROS AUXILIOS

OMOLOGAZIONE EUROPEA DIN 13164
EUROPEAN HOMOLOGATION DIN 13164

- 1X 160X210CM - COPERTA DI SOCCORSO - FIRST AID BLANKET
- 8X 10X6CM - CEROTTI ADESIVI - ADHESIVE DRESSING
- 3X 8X10CM - 1X 10X12CM - PACCHETTO MEDICAZIONE STERILE FIRST AID DRESSING STERILE
- 2X 136X96X96CM - TRIANGOLO BENDAGGIO - TRIANGULAR BANDAGE GRANDE-LARGE
- 2 PAIA GUANTI MONOUSO - 2 PAIRS DISPOSABLE GLOVES
- 1X 5MTX2,5CM - CEROTTO ADESIVO - ADHESIVE TAPE
- 3X 10X10CM - COMPRESSE STERILI DI TNT - WOUND COMPRESS STERILE
- 1X 60X80CM - 2X 40X60CM - TELO STERILE MEDICAZIONE USTIONI BURN DRESSING STERILE
- 3X 8X4CM - 2X 6X4CM - BENDA DI GARZA ELASTICA - ELASTI BANDAG



MASTER 36 INNER 12

CUSCINO ANATOMICO DA VIAGGIO

35025

- CUSCINO ANATOMICO DA VIAGGIO
- HEAD REST PILLOW FOR CERVICAL
- REPOSE TÊTE ANATOMIQUE
- Anatomisches Reisekissen
- COJIN ANATOMICO

Comfortable Quality



MASTER 240 INNER 24

NASTRO AMERICANO

35135

- NASTRO AMERICANO 11MT X 50MM
- DUCT TAPE MULTI WATERPROOF AND HIGHLY ADHESIVE
- RUBAN ADHÉSIF MULTI-USAGES
- Mehrzweck-Klebeband
- MULTIUSOS CINTA ADHESIVA

CARATTERISTICHE

Utilissimo in ogni attività lavorativa e quotidiana
Super sigilla • Super resistente • Ripara
Altamente adesivo
Ottima presa su tutti i materiali rigidi e sui tessuti

11mt x 50mm

MASTER 48 INNER 24



SET UTENSILI IN ACCIAIO

35150

- SET UTENSILI IN ACCIAIO
- MULTI TOOL SET STAINLESS STEEL
- SET DE INSTRUMENTS
- Werkzeug Set
- SET DE INSTRUMENTOS

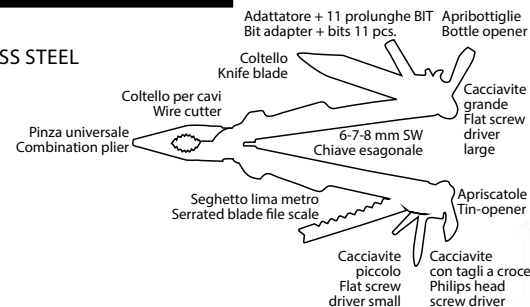

ADATTATORE BIT
+ 11 PROLUNGHE BIT

25 FUNZIONI

MASTER 48 INNER 12



GILET ALTA VISIBILITÀ

35140 - 35145

- GILET ALTA VISIBILITÀ DIN EN 471
- HIGH VISIBILITY JACKET. MADE FROM FLUORESCENT POLYESTER
- GILET DE SIGNALISATION RÉFLÉCHISSANT, HAUTE VISIBILITÉ
- Sicherheitsweste
- CHALECO ALTA VISIBILIDAD

OMOLOGATO

DIN EN 471

35140		GIALLO	YELLOW
35145		ARANCIO	ORANGE

MASTER 96 INNER 24



10 FASCETTE IN METALLO

35060

- 10 FASCETTE IN METALLO
- 10 STEEL ASSORTED HOSE CLAMPS
- 10 COLLIERS DE SERRAGE MULTI-USAGE
- Stahlschellen, Unterschiedlicher Grössen
- 10 ABRAZADERAS SURTIDAS



MASTER 120 INNER 24

CAVO ANTIFURTO

35100

- CAVO ANTIFURTO
- REINFORCED SPRING ANTITHEFT
- ANTIVOL SPIRALE
- Kabelschloss mit Schliesszylinder
- ANTIRROBO ESPIRAL



CON CHIAVE

MASTER 60

SPECCHIETTO DI SICUREZZA

35220

- SPECCHIETTO DI SICUREZZA
- SAFETY MIRROR
- MIROIR DE SÉCURITÉ
- Sicherheit Spiegel
- SEGURIDAD ESPEJO



**IDEALE PER VEDERE I BAMBINI
 SEDUTI DIETRO**



RETROVISORE

CON VENTOSA REGOLABILE

MASTER 96 INNER 24

PROTEGGI SEDILE

35230

- PROTEGGI SEDILE
- FRONT SEAT PROTECTIVE COVER SINGLE PIECE
- HOUSSE DE PROTECTION DU SIEGE
- Vordersitzschutz einzel stuck
- PROTECTOR ASIENTO ANTERIOR

CARATTERISTICHE

Multiuso
 Adattabile a tutti i tipi di sedili
 Con elastici per una maggiore aderenza al sedile

MASTER 20



ESTINTORE SPRAY

31520

- ESTINTORE SPRAY ADATTO PER SPEGNERE PICCOLI FUOCHI
- SPRAY EXTINGUISHER

- EXTINCTEUR
- Feuerlöscher
- EXTINTOR

Viene utilizzato per domare gli incendi sulle auto, sulle barche, negli uffici, nelle case, ecc. Non è tossico, non è dannoso per l'ambiente e neanche macchiante. Può essere utilizzato per estinguere l'attrezzatura elettrica con voltaggio fino a 1000V dalla distanza di 1 metro.

Ideal for extinguishing cars, boats, offices, houses, etc. Nontoxic, environment-friendly, stain-resistant. Can be used to extinguish fires, including electric equipment up to 1000V in distance 1 m.



450ml

MASTER 12

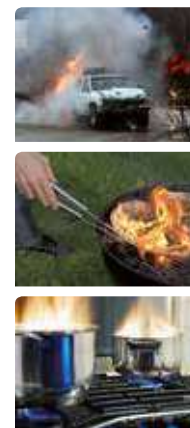

ESTINTORE SPRAY

35196

- ESTINTORE SPRAY ADATTO PER SPEGNERE PICCOLI FUOCHI
- SPRAY EXTINGUISHER

- EXTINCTEUR
- Feuerlöscher
- EXTINTOR

Viene utilizzato per domare gli incendi sulle auto, sulle barche, negli uffici, nelle case, ecc. Non è tossico, non è dannoso per l'ambiente e neanche macchiante. Può essere utilizzato per estinguere l'attrezzatura elettrica con voltaggio fino a 1000V dalla distanza di 1 metro.

Ideal for extinguishing cars, boats, offices, houses, etc. Nontoxic, environment-friendly, stain-resistant. Can be used to extinguish fires, including electric equipment up to 1000V in distance 1 m.



1000ml

MASTER 12

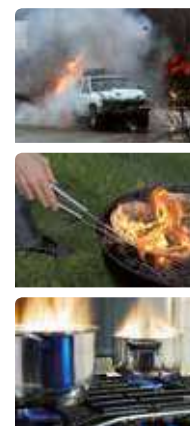

ESTINTORE OMOLOGATO

35195

- ESTINTORE OMOLOGATO DA 1 KG
- FIRE EXTINGUISHER A/B/C RINA HOMOLOGATION - WEIGHT: 1 KG WITH MANOMETER

- EXTINCTEUR
- Feuerlöscher
- EXTINTOR



CON MANOMETRO
WITH MANOMETER

OMOLOGATO



1 kg

MASTER 6

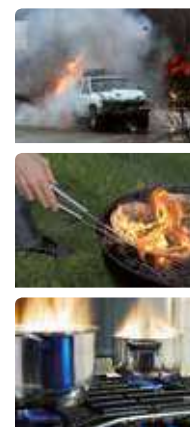

MARTELLO DI EMERGENZA

35115

- MARTELLO DI EMERGENZA
- EMERGENCY HAMMER WITH BLADE FOR SEAT BELTS
- MARTEAU D'URGENCE
- Vorfal Hammer
- MARTILLO DE EMERGENCIA

MULTIFUNZIONE

MASTER 100



MORSETTO STACCA BATTERIA

35020

- MORSETTO STACCA BATTERIA
- AUTO DC POWER REGULATED ADAPTOR
- BORNE D'ISOLATION BATTERIE
- Batterieausschaltungsklemme
- BORNE CONECTOR DE BATERIA

Avvitando si attiva il collegamento, svitando si stacca il collegamento
Funzione anti furto. Connettere al polo positivo (+)

You screw, battery is working, you unscrew, battery is not working. Anti-theft function. Connect to positive pole (+)



SALVA LA BATTERIA FUNGE ANCHE DA ANTIFURTO

MASTER 96 INNER 12

TANICHE OMOLOGATE

35210 - 35215

- TANICHE OMOLOGATE
- JERRY CAN
- BIDON
- Kanister
- BIDÓN



OMOLOGATE

In polietilene rinforzato ad alta densità con travasatore. In caso di grande caldo non riempire più di 3/4 della tanica. Non lasciare vicino a una fonte di calore.

35210 - 10 LT. MASTER 16
35215 - 5 LT. MASTER 25

POMPA ASPIRA LIQUIDI

35120

- POMPA ASPIRA LIQUIDI
- SIPHON PUMP FOR LIQUIDS 100% RUBBER
- POMPE POUR ASPIRER LES LIQUIDES
- Flüssigkeits-Saugpumpe
- BOMBA ASPIRALÍQUIDOS



IN GOMMA

MASTER 72 INNER 12

IMBUTO FLESSIBILE

35185

- IMBUTO FLESSIBILE
- FLEXIBLE FUNNEL
- ENTONNOIR FLEXIBLE
- Flexibler Trichter
- EMBUDO FLEXIBLE



FLESSIBILE

MASTER 96 INNER 24

GUANTI DA LAVORO

35245

- GUANTI DA LAVORO
- PAIR OF WORKING GLOVES
- PAIRE DE GANTS CROUTE
- Ein Paar Arbeitshandschuhe
- PAR DE GUANTES RABAJO



IN NYLON E NITRILE

MASTER 240 INNER 12

GUANTI MONOUSO HDPE

35250

- GUANTI MONOUSO HDPE
- DISPOSABLE POLYETHYLENE GLOVES
- GANTS JETABLES
- Einweghandschuhe
- GUANTES DESECHABLES



50 PZ

IDEALE PER
 Manipolazione temporanea di prodotti alimentari e non.
 Rifornimento stazioni di servizio e moltissimi altri usi

MASTER 96 INNER 12

GUANTI MONOUSO VINILE

35225

- GUANTI MONOUSO VINILE
- DISPOSABLE VINYL GLOVES
- GANTS EN VINYLE
- Vinylhandschuhe
- GUANTES DE VINILO



15 PZ

MASTER 96 INNER 12

TAPPO BENZINA FLESSIBILE

35015

- TAPPO BENZINA
- UNIVERSAL FUEL CAP
- BOUCHON DE RÉSERVOIR UNIVERSEL
- Tankverschluss, universal
- TAPÓN GASOLINA UNIVERSAL



FLESSIBILE

MASTER 100 INNER 50

TORCIA A 27 LED

35105

- TORCIA A 27 LED
- 27 LED FLASHLIGHT PORTABLE
- TORCHE PORTABLE À LED
- 27 Led Taschenlampe tragbare
- 27 LED LINTERNA PORTÁTIL

UTILIZZATE 3 PILE AAA
NON INCLUSE



CON MAGNETE E GANCIO

MASTER 144 INNER 12

TORCIA A DINAMO

35110

- TORCIA A DINAMO
- DYNAMO TORCH WITH 3 LED
- TORCHE DYNAMO AVEC 3 LED
- Dynamo Taschenlampe mit 3 led
- ANTORCHA DEL DINAMO CON 3 LED



RICARICABILE

MASTER 144 INNER 12

10 FUSIBILI CILINDRICI

35050

- 10 FUSIBILI CILINDRICI
- CYLINDRIC FUSES
- FUSIBLES STEATILES ASSORTIS
- Zylindrischen Sicherungen
- FUSIBLES CILINDRICOS SURTIDOS



CILINDRICI

ASSORTITI

MASTER 500 INNER 50

10 MINI FUSIBILI BILAMA

35045

- 10 MINI FUSIBILI BILAMA OMOLOGATI
- MINI DOUBLE BLADE FUSES
- MINI FUSIBLES ENFICHABLES ASSORTIS
- Bimetallsicherungen verschiedener grössen
- MINI FUSIBLES BILAMA SURTIDOS



MINI

MASTER 500 INNER 50

10 FUSIBILI BILAMA

35040

- 10 FUSIBILI BILAMA
- DOUBLE BLADE FUSES
- FUSIBLES ENFICHABLES ASSORTIS
- Bimetallsicherungen verschiedener grössen
- FUSIBLES BILAMA SURTIDOS



MASTER 500 INNER 50

PRESA ACCENDISIGARI

35065 12V-24V

- PRESA ACCENDISIGARI CON CAVO
- QUADRUPLE CIGARETTE LIGHTER PLUG WITH CABLE
- PRISE QUADRUPLE ALLUME-CIGARE AVEC CÂBLE
- Vierfache Steckerbuchse für Zigarettenanzünder mit Kabel
- CUÁDRUPLE TOMA ENCENDEDOR CON CABLE



12V/24V

MASTER 96 INNER 24

PRESA ACCENDISIGARI

35070 12V-24V

- PRESA ACCENDISIGARI CON CAVO
- DOUBLE SOCKET MULTIPURPOSE WITH EXTENDIBLE CABLE
- PRISE DOUBLE ALLUME-CIGARE AVEC CÂBLE ALLONGEABLE
- Doppelte Steckerbuchse für Zigarettenanzünder mit verlängerbarem Kabel
- DOBLE TOMA ENCENDEDOR CON CABLE EXTENSIBLE



MASTER 96 INNER 24

INVERTITORE/CONVERTITORE DI CORRENTE

35075

- INVERTITORE DI CORRENTE
- POWER INVERTER
- CONVERTISSEUR DE COURANT
- Stromumwandler mit Verlängerung
- CONVERTIDOR DE CORRIENTE

12V → 220V

220V/150W



MASTER 12

COPRIAUTO UNIVERSALE

35240

- COPRIAUTO UNIVERSALE ANTIGRAFFIO
- CAR COVER POLYESTER & NON-WOVEN MATERIAL COMBINED 100% WATERPROOF DOUBLE LAYER
- HOUSSE AUTO EN POLYESTER 100% DOUBLE COUCHE IMPERMEABLE
- Autoplane aus Polyester 100% Undurchlässige Doppelschicht
- FUNDA CUBREAUTO EN POLYESTER 100% DOBLE CAPA IMPERMEABLE



IMPERMEABILE

ANTIGRAFFIO



MASTER 24 INNER 12

VENTOSA RIPARA CARROZZERIA

35130

- VENTOSA RIPARA CARROZZERIA
- SUCTION CUP REPAIRER BODYWORK
- VENTOUSE REPARATEUR DE LA CARROSSERIE
- Saugnapf Karosserie Reparationen
- VENTOSA REPARA-CARROCERIA



MASTER 48



CORDA TRAINO ELASTICA

35160

- CORDA TRAINO ELASTICA 2800 KG - 4 MT
- ELASTICIZED TOW ROPE FOR UP TO 2800 KG
- CORDE ÉLASTIQUE POUR REMORQUE DE 2800 KG
- Elastisches Abschleppseil 2800 kg
- CUERDA REMOLQUE 2800 KG

2800 Kg

MASTER 12



CHIAVE FILTRO A NASTRO

35125

- CHIAVE FILTRO A NASTRO DA 60 A 111 MM
- UNIVERSAL OIL FILTER WRENCH
- CLEF UNIVERSELLE POUR FILTRE À HUILE
- Universalschlüssel Ölfilter Ermöglicht das Austauschen von Filtern
- LLAVE FILTRO ACEITE UNIVERSAL

Da Ø 60 a Ø 111 MM



MASTER 60 INNER 12



MISURA PRESSIONE PNEUMATICI

35000

- MISURA PRESSIONE PNEUMATICI UNIVERSALE
- TYRE PRESSURE GAUGE
- MANOMÈTRE PRESSION PNEUS
- Manometer für die kontrolle des reifendrucks
- MANOMETRO PRUEBA PRESSION NEUMATICOS

UNIVERSALE

MASTER 144 INNER 24



TROUSSE H1

35085

- TROUSSE H1 5 LAMPADE + 2 FUSIBILI
- HOMOLOGATED H1 HALOGEN BULB
- TROUSSES AMPOULES H1
- Satz Zugelassener Lampen H1
- ESTUCHE LÁMPARAS H1

+50% LIGHT

MASTER 60 INNER 12

1-ALOGENA	H1-P14,5s
1-2 FILAMENTI	P21/5W-BAY15d
1-1 FILAMENTO	P21W-BA15s
1-MICRO	R5W-BA15s
1-MICRO	T4W-BA 9s
2-FUSIBILI	10A-15A



TROUSSE H4

35090

- TROUSSE H4 5 LAMPADE + 2 FUSIBILI
- HOMOLOGATED H4 HALOGEN BULB
- TROUSSES AMPOULES H4
- Satz Zugelassener Lampen H4
- ESTUCHE LÁMPARAS H4

+50% LIGHT

MASTER 60 INNER 12

1-ALOGENA	H4-P43t
1-2 FILAMENTI	P21/5W-BAY15d
1-1 FILAMENTO	P21W-BA15s
1-MICRO	R5W-BA15s
1-MICRO	T4W-BA 9s
2-FUSIBILI	10A-15A



TROUSSE H7

35095

- TROUSSE H7 5 LAMPADE + 2 FUSIBILI
- HOMOLOGATED H7 HALOGEN BULB
- TROUSSES AMPOULES H7
- Satz Zugelassener Lampen H7
- ESTUCHE LÁMPARAS H7

+50% LIGHT

MASTER 60 INNER 12

1-ALOGENA	H7-PX26d
1-2 FILAMENTI	P21/5W-BAY15d
1-1 FILAMENTO	P21W-BA15s
1-MICRO	R5W-BA15s
1-MICRO	T4W-BA 9s
2-FUSIBILI	10A-15A



RETE ELASTICA DI SICUREZZA

35235

- RETE ELASTICA DI SICUREZZA 38 X 75 CM
- BAGGAGE NET SIZE 38 X 75 CM Ø 4 MM, WITH 8 SAFETY HOOKS
- DIMENSION DU FILET DU COFFRE À BAGAGES 38 X 75 CM Ø 4 MM AVEC 8 SANGLES DE SECURITÉ
- Maße für das Trennnetz 38 x 75 cm ø 4 mm, mit 8 Sicherheitshaken
- CUBRE-EQUIPAJES TAMAÑO 38 X 75 CM Ø 4 MM CON 8 GANCHOS DE SEGURIDADES

38 x 75 cm

CON 8 GANCI

MASTER 144 INNER 12





DEODORANTI

NATURAL PERFUMES

SUPPORTO VENDITA DEODORANTI





DEODORANTI

PERFUMES

SCENTED MINI BOTTLE - JELLO	pag 268
INTENSE - AIR PERFUME - TULIP CLASSIC	pag 269
MON LUX - X VERSION - DRY SMILE	pag 270
MON CLASSIC - SPORT LUX	pag 271
MY PUPPY	pag 272
ARBRE MAGIQUE	pag 273
BRACCIALETTO ALLONTANA ZANZARE	pag 274



SCENTED MINI BOTTLE

21300-21301-21302-21303-21304-21305-21306

- PROFUMAZIONI NATURALI PER AUTO
- NATURAL PERFUMES FOR CAR
- SENTEURS NATURELLES POUR AUTO
- Natürliche Duftstoffe für Auto
- AROMAS NATURALES PARA AUTOMÓVIL

MASTER 7

21301 BREEZE



21302 LEMON



21303 VANILLA



21304 STRAWBERRY



21305 TROPICAL FRUITS



21306 CHERRY



21300 APPLE

SCENTED MINI BOTTLE BARATTOLO

21308

- PROFUMAZIONI NATURALI PER AUTO
- NATURAL PERFUMES FOR CAR
- SENTEURS NATURELLES POUR AUTO
- Natürliche Duftstoffe für Auto
- AROMAS NATURALES PARA AUTOMÓVIL

Pz 44

**Mix di
Fragranze!**
Mix fragrances in big jar



MASTER 1

JELLO

21340-21341-21342-21343-21344-21345

- PROFUMAZIONI NATURALI PER AUTO
- NATURAL PERFUMES FOR CAR
- SENTEURS NATURELLES POUR AUTO
- Natürliche Duftstoffe für Auto
- AROMAS NATURALES PARA AUTOMÓVIL



21341 Breeze

21342 Lemon

21343 Pine

21344 Tropical Fruits

21345 Vanilla

MASTER 12



21340 Apple

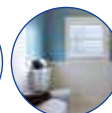

INTENSE

21320-21321-21322-21323-21324-21325

- PROFUMAZIONI NATURALI PER AUTO
- NATURAL PERFUMES FOR CAR
- SENTEURS NATURELLES POUR AUTO
- Natürliche Duftstoffe für Auto
- AROMAS NATURALES PARA AUTOMÓVIL



MASTER 36

AIR PERFUME

21330-21331-21332-21333-21334-21335

- PROFUMAZIONI NATURALI PER AUTO
- NATURAL PERFUMES FOR CAR
- SENTEURS NATURELLES POUR AUTO
- Natürliche Duftstoffe für Auto
- AROMAS NATURALES PARA AUTOMÓVIL

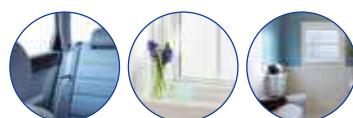

MASTER 24



TULIP CLASSIC

21310-21311-21312-21313

- PROFUMAZIONI NATURALI PER AUTO
- NATURAL PERFUMES FOR CAR
- SENTEURS NATURELLES POUR AUTO
- Natürliche Duftstoffe für Auto
- AROMAS NATURALES PARA AUTOMÓVIL



21310 GREEN APPLE



21311 LEMON



21312 SPORT



21313 VANILLA

MASTER 36

MON LUX

21400-21401-21402-21403-21404-21405-21406-21407-21408
21409-21410-21411-21412-21413-21414-21415-21416-21417

- PROFUMAZIONI NATURALI PER AUTO
- NATURAL PERFUMES FOR CAR
- SENTEURS NATURELLES POUR AUTO
- Natürliche Duftstoffe für Auto
- AROMAS NATURALES PARA AUTOMÓVIL



21400 LEATHER 21401 VANILLA CHOCO 21402 ELEGANCE 21403 BEVERLY HILLS 21404 MIAMI BEACH 21405 YACHTING 21406 COCONUT 21407 MOJITO 21408 MELON



21409 PARTY 21410 MOUNTAIN FRESH 21411 SUMMER DREAM 21412 LILAC 21413 BUBBLE GUM 21414 TORTUGA 21415 BLACK CRYSTAL 21416 VANILLA BUBBLE 21417 VANILLA MIA

MASTER 360 INNER 10

X VERSION

21470-21471-21472

- PROFUMAZIONI NATURALI PER AUTO
- NATURAL PERFUMES FOR CAR
- SENTEURS NATURELLES POUR AUTO
- Natürliche Duftstoffe für Auto
- AROMAS NATURALES PARA AUTOMÓVIL



21470 PARTY 21471 VANILLA 21472 BUBBLE GUM
MASTER 360 INNER 10

DRY SMILE

21430-21431-21432 - 21433
21434-21435

- PROFUMAZIONI NATURALI PER AUTO
- NATURAL PERFUMES FOR CAR
- SENTEURS NATURELLES POUR AUTO
- Natürliche Duftstoffe für Auto
- AROMAS NATURALES PARA AUTOMÓVIL



21430 VANILLA 21431 BUBBLE GUM 21432 NO SMOKING 21433 TUTTI FRUTTI 21434 FRESH AIR 21435 BLACK CRYSTAL
MASTER 360 INNER 10

MON CLASSIC

**21450-21451-21452-21453-21454-21455-21456
21457-21458-21459**

- PROFUMAZIONI NATURALI PER AUTO
- NATURAL PERFUMES FOR CAR
- SENTEURS NATURELLES POUR AUTO
- Natürliche Duftstoffe für Auto
- AROMAS NATURALES PARA AUTOMÓVIL



MASTER 360 INNER 10

SPORT LUX

21480-21481-21482-21483-21484-21485

- PROFUMAZIONI NATURALI PER AUTO
- NATURAL PERFUMES FOR CAR
- SENTEURS NATURELLES POUR AUTO
- Natürliche Duftstoffe für Auto
- AROMAS NATURALES PARA AUTOMÓVIL



MASTER 360 INNER 10

MY PUPPY

29501

- PROFUMAZIONI NATURALI PER AUTO
- NATURAL PERFUMES FOR CAR
- SENTEURS NATURELLES POUR AUTO
- Natürliche Duftstoffe für Auto
- AROMAS NATURALES PARA AUTOMÓVIL



**Strofina il blister e scopri
la tua fragranza preferita!**



CANE **BOUQUET**



PAPERO **LAVANDA**



MUCCA **LAVANDA**



PECORA **VANIGLIA**



ASINELLO **BOUQUET**

MAIALINO **VANIGLIA**



Soft Animal!
Morbido
Pelouche!

**2 ANIMALETTI
PER TIPO DI FRAGRANZA
12 PEZZI ASSORTITI**

MASTER 48 INNER 12

PROFUMI

ARBRE MAGIQUE

- PROFUMAZIONI NATURALI PER AUTO
- NATURAL PERFUMES FOR CAR
- SENTEURS NATURELLES POUR AUTO
- Natürliche Duftstoffe für Auto
- AROMAS NATURALES PARA AUTOMÓVIL



art. TA102262
PINO



art. TA102268
VANIGLIA



art. TA102290
FRESH WATER



art. TA102270
LAVANDA



art. TA102238
MENTA GLACIALE



art. TA102278
AUTO NUOVA



art. TA102240
SPORT



art. TA102252
COCCO



art. TA102260
MELA VERDE



art. TA102256
FRUTTI DI BOSCO



art. TA102254
FRUIT COCKTAIL



art. TA102258
LEMON



art. TA102274
FRAGOLA



art. TA102320
ITALIAN BREEZE



art. TA102282
BLACK PINE



art. TA102328
COLONIA



art. TA102312
MUSCHIO BIANCO



art. TA102298
TARTAN COLOGNE



art. TA102294
CASHMERE FLOWER



art. TA102300
VINTAGE FRUIT



art. TA102322
IBIZA
COCKTAIL



art. TA102330
MANGO
& PAPAYA



art. TA102308
JASMINE
& NARCISSUS



art. TA102310
VIOLET
& GARDENIA



art. TA102306
GREEN FOREST
& BERGAMOT



art. TA102324
BREZZA DI
MYCONOS



art. TA102326
AGRUMI DI
CAPRI

MASTER 24

BRACCIALETTO ALLONTANA ZANZARE

20992

- BRACCIALETTO ALLONTANA ZANZARE CON OLIO VEGETALE DI ANDIROBA
- NATURAL PERFUMED SILICON WRISTBAND WITH ORGANIC ANDIROBA OIL
- BRACELET EN SILICONE NATUREL PARFUMÉ
- Natürliches parfümiertes Silikonarmband
- PULSERA DE SILICONA NATURAL PERFUMADA

CON OLIO VEGETALE DI ANDIROBA*



DURATA 6 SETTIMANE / 6 WEEKS LIFETIME

NON E' UN GIOCATTOLO / IT'S NOT A TOY

100% MADE IN ITALY

Perfetto anche in acqua/perfect also in water - Neutro sulla pelle/Mild on the skin
Non macchia, non unge/it doesn't stain - Agganciabile a passeggini e carrozzine/it can be coupled to baby strollers
Durata 6 settimane/6 weeks lifetime

BRACCIALE ALLONTANA ZANZARE

Bracciale in idonea plastica profumata, addizionata di olio vegetale di Andiroba, estratto ed usato nella foresta amazzonica, per allontanare zanzare e insetti.

Il profumo viene rilasciato progressivamente allontanando zanzare e insetti. Le due ricariche allegate, prolungano l'efficacia del prodotto fino a 6 settimane. Il cinturino è regolabile per comodità, si può eliminare la parte in eccesso, lungo la scanalatura.

Può essere indossato al polso, alla caviglia o agganciare a passeggini e carrozzine durante le attività all'aperto: gioco, sport, giardinaggio, jogging, campeggio, pic-nic ecc...

In acqua non perde la sua efficacia e non si deteriora.



***Estratto e usato nella foresta Amazzonica**

MASTER 480 INNER 24

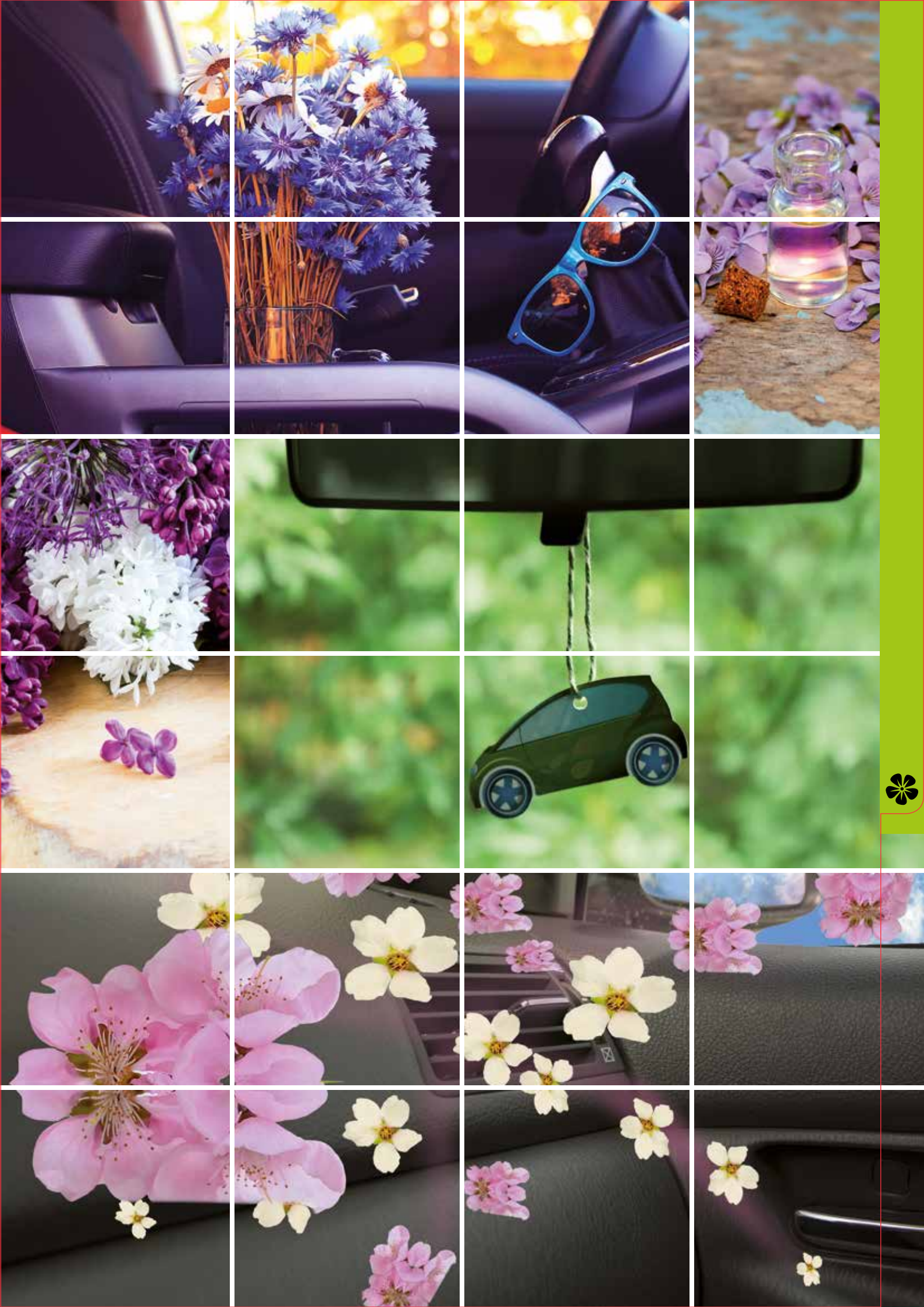



MANUTENZIONE - ELETTRICI HARDWARE TOOLS - ELECTRICAL ITEMS

SUPPORTO VENDITA MANUTENZIONE - ELETTRICI



www.Bottari.it
Bottari
ITALY





MANUTENZIONE - ELETTRICI

HARDWARE TOOLS - ELECTRICAL ITEMS

MANUTENZIONE pag 278
ELETTRICI pag 284



BIG-TIRE 140PSI

24061

- COMPRESSORE CON MANOMETRO E ATTACCO ACCENDISIGARI
- COMPRESSOR WITH MANOMETER AND CIGARETTE LIGHTER ATTACHMENT
- COMPRESSEUR AVEC MANOMETRE ET ATTACHE ALLUME-CIGARES
- Kompressor mit Manometer und Zigarettenanzünder-Befestigung
- COMPRESOR CON MANOMETRO Y CONEXIÓN AL MECHERO

24061	12V-12A	140 PSI	2 m
-------	---------	---------	-----



CAVO ALIMENTAZIONE 2m CON 3 ADATTATORI + 1 AGO
2m POWER CORD WITH 3 ADAPTORS + 1 NEEDLE

IDEALE PER FURGONI, SUV E AUTO 4X4
SUITABLE FOR VAN'S SUV, CARS 4X4

PROFESSIONALE



MASTER 12

WHEEL 260PSI

24054

- COMPRESSORE CON MANOMETRO E ATTACCO ACCENDISIGARI
- COMPRESSOR WITH MANOMETER AND CIGARETTE LIGHTER ATTACHMENT
- COMPRESSEUR AVEC MANOMETRE ET ATTACHE ALLUME-CIGARES
- Kompressor mit Manometer und Zigarettenanzünder-Befestigung
- COMPRESOR CON MANOMETRO Y CONEXIÓN AL MECHERO

24054	12V-12A	260 PSI	2 m
-------	---------	---------	-----



CAVO ALIMENTAZIONE 2m CON 3 ADATTATORI + 1 AGO
2m POWER CORD WITH 3 ADAPTORS + 1 NEEDLE

IDEALE PER FURGONI, SUV E AUTO 4X4
SUITABLE FOR VAN'S SUV, CARS 4X4



MASTER 12

STRONG 250PSI

24050

- COMPRESSORE CON MANOMETRO E ATTACCO ACCENDISIGARI
- COMPRESSOR WITH MANOMETER AND CIGARETTE LIGHTER ATTACHMENT
- COMPRESSEUR AVEC MANOMETRE ET ATTACHE ALLUME-CIGARES
- Kompressor mit Manometer und Zigarettenanzünder-Befestigung
- COMPRESOR CON MANOMETRO Y CONEXIÓN AL MECHERO

24050	12V-12A	250 PSI	2 m
-------	---------	---------	-----



CAVO ALIMENTAZIONE 2m CON 3 ADATTATORI + 1 AGO
2m POWER CORD WITH 3 ADAPTORS + 1 NEEDLE

IDEALE PER FURGONI, SUV E AUTO 4X4
SUITABLE FOR VAN'S SUV, CARS 4X4



MASTER 24

COMPRESSORE CON MANOMETRO

77364

- COMPRESSORE CON MANOMETRO E ATTACCO ACCENDISIGARI
- COMPRESSOR WITH MANOMETER AND CIGARETTE LIGHTER ATTACHMENT
- COMPRESSEUR AVEC MANOMETRE ET ATTACHE ALLUME-CIGARES
- Kompressor mit Manometer und Zigarettenanzünder-Befestigung
- COMPRESOR CON MANOMETRO Y CONEXIÓN AL MECHERO

77364	12V	250 PSI	2m
-------	-----	---------	----

- | | |
|---------------------------------------|----------------------------|
| 1. MANOMETRO | 1. PRESSURE GAUGE |
| 3. CAVO DA 2m CON SPINOTTO | 3. 2m CORE WITH PLUG |
| 4. ADATTATORE PER PNEUMATICI PER AUTO | 4. ADAPTER FOR CAR TIRE |
| 5. AGO SFERICO | 5. BALL NEEDLE |
| 6. ADATTATORE PER GONFIABILI | 6. ADAPTER FOR INFLATABLES |
| 7. ADATTATORE PER BARCHE IN PVC | 7. ADAPTER FOR PVC BOATS |

**IDEALE PER PNEUMATICI AUTO - MOTO
BICI E ATTREZZATURE SPORTIVE
SUITABLE FOR CAR, MOTORBIKE AND BIKE TIRES AND SPORTS GOODS**

MASTER 24



XS-LINE

24065

- SIGILLANTE RIPARAZIONE RAPIDA
- TYRE REPAIR KIT
- KIT DE REPARATION POUR PNEUS
- Reifen-reparaturkit
- KIT PARA REPARACIÓN DE PNEUMÁTICOS

Il Kit contiene:

- | | |
|----------------------------------|------------------------|
| 1 compressore | 1 compressor |
| 1 flacone di sigillante da 500ml | 1 500ml sealant bottle |
| 1 tubetto applicatore | 1 pipe |
| 1 estraattore corpo valvola | 1 valve puller |
| 1 corpo valvola di riserva | 1 spare valve core |
| 1 paio di guanti in gomma | 1 pair of latex gloves |

Kit contains:

- | |
|------------------------|
| 1 compressor |
| 1 500ml sealant bottle |
| 1 pipe |
| 1 valve puller |
| 1 spare valve core |
| 1 pair of latex gloves |



1. Posizionare la ruota in modo che la valvola rimanga orientata verso l'alto.
GB. Turn the wheel until the valve is facing high.
2. Rimuovere il corpo della valvola con l'estrattore in dotazione.
GB. Remove the valve core using the provided puller.
3. Inserire il tubicino in plastica nella valvola e versare l'intero contenuto del flacone nel pneumatico.
GB. Connect the valve to the plastic tube and pour all the liquid inside the tire.



4. Riposizionare il corpo della valvola nella sua sede.
GB. Re-install the valve core.
5. Procedere al gonfiaggio del pneumatico con il compressore in dotazione collegandolo alla presa 12V dell'auto a motore acceso, rispettando le avvertenze del costruttore.
GB. Inflate the tire with the provided compressor connecting it to the 12V socket with engine turned on, following the manufacturer recommendations.
6. Compiere qualche centinaio di metri mantenendo una velocità moderata per un' omogenea distribuzione del liquido sigillante all'interno della gomma.
GB. Drive a little and keep a low speed for a perfect spread of the sealant liquid inside the tire.
7. Dopo un breve tragitto fermarsi per un controllo della pressione ed eseguire un eventuale rigonfiaggio se necessario. Buon viaggio.
GB. After a short run, stop the car and check the pressure, inflating again if necessary. Have a good trip.

**compressore
150 PSI
12V**

MASTER 12



L'ORIGINALE



XS-LINE RICARICA

24066 - 500ml

MASTER 12



KIT CHIAVI TOP2

24013 - 30 PEZZI

- KIT CHIAVI 30 PEZZI
- SPANNER KIT 30 PIECE
- KIT DE CLEFS 30 PIECES
- Kit schlüssel 30 stück
- KIT LLAVES 30 PIEZAS

ASSORTIMENTO DI UTENSILI PER
AUTO CASA, FAI DA TE

ASSORTMENT OF TOOLS FOR USE
IN CAR AT HOME, DIY



MATERIALE GARANTITO
**CHROME
VANADIUM**
GUARANTEED MATERIAL



MASTER 6

CHIAVI SVITA CANDELE

24138 - 24139 - 24146 - 24147

- CHIAVE SVITACANDELE
- SPARK PLUG WRENCH
- CLEF D'EXTRACTION BOUGIES
- Kerzenschlüssel
- LLAVE BUJÍAS

	DIAMETRO	MASTER	INNER
24138	Ø 16 mm	60	12
24139	Ø 21 mm	60	12
24146	Ø 16 mm	48	12
24147	Ø 21 mm	48	12

art. 24146
Ø 16 mm
DE LUXE



art. 24147
Ø 21 mm
DE LUXE



art. 24139
Ø 21 mm
CORTA



art. 24138
Ø 16 mm
CORTA



CON MANICO LUNGO

CHIAVE RAMBO

24029

- SET DI STRUMENTI IN ACCIAIO INOX
- MULTI TOOL SET STAINLESS STEEL
- SET DE INSTRUMENTS EN ACIER INOX
- Werkzeug Set aus Inox
- SET DE INSTRUMENTOS EN ACERO INOX

ADATTATORE BIT + 11 PROLUNGHE BIT
BIT ADAPTER + BITS 11 PCS
17 CM

ACCIAIO-STEEL

25 FUNZIONI-FUNCTIONS

MASTER 48 INNER 12

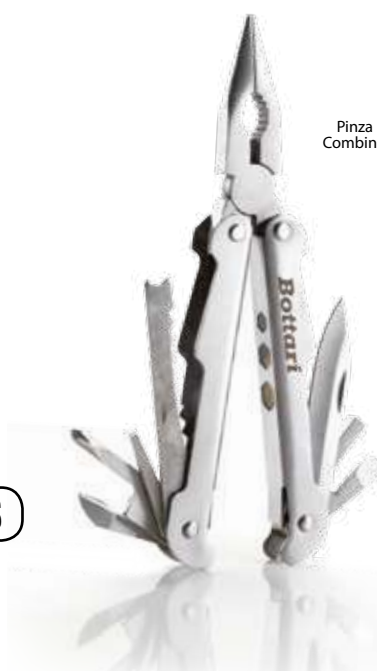

- Adattatore + 11 prolunghe BIT / Bit adapter + bits 11 pcs
- Apribottiglie / Bottle opener
- Coltello / Knife blade
- Cacciavite grande / Flat screw driver large
- Coltello per cavi / Wire cutter
- 6-7-8 mm SW / Chiave esagonale
- Apriscatole / Tin-opener
- Pinza universale / Combination plier
- Seghetto lima metro / Serrated blade file scale
- Cacciavite piccolo / Flat screw driver small
- Cacciavite con tagli a croce / Philips head screw driver



POMPE A PEDALE

24055 - 24056

- POMPA GONFIAGGIO A PEDALE, CON MANOMETRO
- CYLINDER PEDAL PUMP, WITH MANOMETER
- POMPE À PIED CYLINDRE, AVEC MANOMETRE
- Einzylinder-fusspumpe mit manometer
- BOMBA DE AIRE CILINDRO, CON MANOMETRO



24055	1 CILINDRO	100 PSI	MASTER 12
24056	2 CILINDRI	100 PSI	MASTER 12



ESTRATTORE OLIO ELETTRICO

30669

- ESTRATTORE OLIO
- OIL EXTRACTOR
- EXTRAIT D'HUILE
- Öl-Extraktor
- EXTRACTOR DE ACEITE

COLLOCARE L'ESTRATTORE DI OLIO IN UNA POSIZIONE SICURA. PRIMA DI COMINCIARE A LAVORARE, ASSICURARSI CHE LA POMPA SIA CORRETTAMENTE COLLEGATA, PLUS CON PLUS E MINUS CON MINUS. PROTEGGERE IL CAVO DI CORRENTE DAL CALORE E DA OGGETTI APPUNTITI. ASSICURARSI CHE L'OLIO VECCHIO NON COLI NEL TERRENO O NEL SISTEMA DI ACQUE DI SCOLO.

SET THE OIL EXTRACTOR UP SECURELY. BEFORE STARTING TO WORK, MAKE SURE THAT THE PUMP IS CORRECTLY CONNECTED, PLUS WITH PLUS AND MINUS WITH MINUS. PROTECT THE POWER SUPPLY CABLE AGAINST HEAT AND SHAP EDGES. ENSURE THAT NO OLD OIL CAN SEEP INTO THE GROUND INTO THE SEWAGE SYSTEM.

**MODELLO PROFESSIONALE PER OFFICINE
 PROFESSIONAL MODEL FOR WORKSHOPS**



**ESTRATTORE OLIO ELETTRICO
 CAMBIARE OLIO IN MODO VELOCE E PULITO**

MASTER 12

LIFT 2TON

77170

- CRIC IDRAULICO A BOTTIGLIA DA 2 T
- 2 T HYDRAULIC JACK
- CRIC HYDRAULIQUE AVEC BOUTEILLE DE 2 T
- Flaschen-Wagenheber 2 T
- GATO HIDRÁULICO DE BOTELLA DE 2 T

GOODYEAR

MASTER 8

**CON VALVOLA DI SICUREZZA
WITH SAFETY**



LIFT 4TON

77171

- CRIC IDRAULICO A BOTTIGLIA DA 4 T
- 4 T HYDRAULIC JACK
- CRIC HYDRAULIQUE AVEC BOUTEILLE DE 4 T
- Flaschen-Wagenheber 4 T
- GATO HIDRÁULICO DE BOTELLA DE 4 T

GOODYEAR

MASTER 6

**CON VALVOLA DI SICUREZZA
WITH SAFETY**



LIFT 1TON

77467

- CRIC A PANTOGRAFO 1 T
- SCISSOR JACK, 1 TON CAPACITY
- CRIC À PANTOGRAPHES 1 T
- Scheren-Wagenheber tragfähigkeit 1 Ton
- GATO TIPO PANTÓGRAFO 1 T

GOODYEAR

MASTER 8

**ALTEZZA
DI SOLLEVAMENTO
95-350 mm
RAISES UP TO A HEIGHT
OF 95-350 mm**



TROLLEY 2TON

77468

- CRIC IDRAULICO A CARRELLO DA 2 T
- 2 T HYDRAULIC FLOOR JACK
- VÉRIN HYDRAULIQUE POUR CHARIOT 2 T
- Hydraulischer Wagenheber mit 2 T Wagen
- 2 T CARRETILLA HIDRÁULICA JACK

GOODYEAR

MASTER 1

**LEVA DISINSERIBILE
CON MANIGLIA IN GOMMA
RUOTE PIROETTANTI A 360°
TELAIO E BRACCIO IN ACCIAIO
RELEASE LEVER WITH RUBBER HANDLE
360° REVOLVING WHEELS
STEEL FRAME AND SUPPORT**



ANTI-FREEZE + DENSIMETRO PER BATTERIA

24141

24143

- TESTER ANTIGELO CILINDRICO
 - PROFESSIONAL ANTIFREEZE TESTER
 - TESTER PROFESSIONNEL ANTIGEL
 - Professioneller Frostschutz-Tester TZ-TESTER
 - TESTER ANTICONGELANTE PROFESIONAL
- MASTER 100 INNER 10

ADATTO PER TUTTI I TIPI DI LIQUIDI ANTIGELO CONTENENTI GLICOLE ETILENICO
 SUITABLE FOR ALL TYPES OF ANTIFREEZE LIQUID CONTAINING ETHYLENE GLYCOL



SIPHON PUMP

28069

- POMPA IN GOMMA ASPIRA LIQUIDI
 - SIPHON PUMP FOR LIQUIDS 100% RUBBER
 - POMPE POUR ASPIRER LES LIQUIDES CAOUTCHOUC 100%
 - Flüssigkeits-Saugpumpe 100% Gummi
 - BOMBA ASPIRALÍQUIDOS GUMA 100%
- MASTER 72 INNER 12

IN GOMMA



IMBUTO FLESSIBILE

24041 - TUBO FLEX

- IMBUTO FLESSIBILE
- FLEXIBLE FUNNEL
- ENTONNOIR FLEXIBLE
- Flexibler Trichter
- EMBUDO FLEXIBLE

MASTER 96 INNER 24

FLESSIBILE



KIT 4 IMBUTI

24042 - Ø53/75/100/120

- IMBUTI ASSORTITI
- ASSORTED FUNNELS
- LOT DE 4 ENTONNOIRS ASSORTIS
- Trichterset
- 4 EMBUDOS SURTIDOS

MASTER 50



JUNIOR

24135

- CHIAVE FILTRO OLIO A CATENA
- CHAIN-TOOL FOR OIL FILTER
- CLÉ FILTRE À HUILE
- Schlüssel mit Streifen für ölfilter
- LLAVE FILTRO ACEITE

MASTER 60 INNER 12



JUNIOR FILTER

24129

- CHIAVE FILTRO OLIO A NASTRO
- BELT-TOOL FOR OIL FILTER
- CLÉ FILTRE À HUILE
- Schlüssel mit Streifen für ölfilter
- LLAVE FILTRO ACEITE

MASTER 60 INNER 12



10 FASCETTE INOX

24038

- 10 FASCETTE ASSORTITE IN ACCIAIO
- 10 STEEL ASSORTED HOSE CLAMPS
- 10 COLLIERS DE SERRAGE MULTI-USAGE ASSORTIS EN ACIER
- 10 Stahlschellen, unterschiedlicher grössen
- 10 ABRAZADERAS SURTIDAS DE ACERO

MASTER 120 INNER 24



CARICA BATTERIA 4 AMPERE - 12V

77350

- CARICA BATTERIA 4 AMPERE - 12V CON PROTEZIONE CONTRO SURRISCALDAMENTO
- 4 AMPERE BATTERY CHARGER. PROTECTION AGAINST THERMAL OVERLOAD
- CHARGEURS DE BATTERIE 4AMP. PROTECTION THERMIQUE CONTRE SURCHARGE
- Batterieladegerate 4amp. Thermischer Überlastungsschutz
- CARGADOR DE BATERÍAS 4AMP. PROTECCION TERMICA CONTRA SOBRECARGAS



CARATTERISTICHE:
 Entrata: 230 V AC, 50-60 Hz, 60-70W
 Uscita: 12 V - 2.7-2.8 A DC
 Capacità minima: 20 Ah
 • CONFORME A:
 EN 60335 parte 2 sezione 2.29

FEATURES:
 Input: 230 V AC, 50-60 Hz, 60-70W
 Output: 12 V - 2.7-2.8 A DC
 Minime capacity: 20 Ah
 • IN ACCORDANCE WITH:
 EN 60335 part 2 section 2.29

OMOLOGATO SECONDO LE ULTIME NORMATIVE EUROPEE

MASTER 12

MANTENITORE DI CARICA PER BATTERIE

77352

- PLUG-IN CARICATORE BATTERIA AL PIOMBO
- PLUG IN LEAD ACID BATTERY CHARGER
- BRANCHEMENT CHARGEUR DE BATTERIE ACIDE/PLOMB
- Ladestecker Für Bleibatterie
- CONECTAR EL CARGADOR BATERIA A PLOMO



CARATTERISTICHE:
 Tensione in ingresso: 230V AC
 Tensione in uscita 6V & 12V DC
 Portata massima 500mA
 Spina di uscita: CLIP BATT. ROSSO E NERO

FEATURES:
 Input Voltage: 230V AC
 Output Voltage 6V & 12V DC
 Maximum Load 500mA
 Output plug: RED AND BLACK BATT. CLIP

IDEALE PER:

• AUTO • MOTO • FURGONI
 • CAMPER • BARCHE ECC...

**230V AC
 6V & 12V DC**



INPUT: 230V ~ 50Hz 50mA
 OUTPUT: 6V or 12V ---
 CURRENT: 500mA



MASTER 24

CARICA BATTERIA 6 AMPERE - 12V

28107

- CARICA BATTERIA 6 AMPERE - 12V
- 6 AMPERE BATTERY CHARGER
- CHARGEURS DE BATTERIE 6AMP.
- Batterieladegerate 6AMP.
- CARGADOR DE BATERÍAS 6AMP.



12V - 6A

MODELLO PROFESSIONALE IN ALLUMINIO



230 V / 50 Hz, 50 W



6V / 12 V \Rightarrow 4.2 A arithm / 6 A eff



Input Voltage	Output Current	Working Efficiency	Unit Weight	Output Voltage



MASTER 12



USB CHARGE KIT

30244

- CAVO UNIVERSALE MULTIFUNZIONE DATI/RICARICA USB 10 IN 1
- UNIVERSAL CABLE MULTIFUNCTION DATA / CHARGING USB 10IN1
- CHARGEUR DE PORTABLE DE VOITURE 10 IN 1
- Handy-Auflader für das Auto 10 IN 1
- CARGADOR DE MOVIL PARA COCHE 10 IN 1



12V/24V

MASTER 96 INNER 12

Cellulari-Navigatori iPhone-iPad-iPod-Tablet-PC ecc...
NOKIA - LG - SAMSUNG - APPLE (tutti/all) - PSP - BLACKBERRY
SONY - HTC - NGM - HUAWAI ecc.



Cavo USB universale dati ed alimentazione per SmartPhones ed apparati multimediali mobili.
Cavo unico: pratico e comodo, permette di avere la presa corretta con un unico cavetto. USB: standard 2.0
Ricarica/Trasferisce dati: Apple (tutti/all), Nokia, LG, Samsung, PSP, Blackberry, Sony, HTC, NGM Huawei e tutti gli
apparati dotati di Micro e Mini USB. Lunghezza Cavo: 95 cm.

Universal USB power and data link, suitable for Smartphones, portable games and music devices.
All in one cable. Eliminates the hassle of multiple cables. USB: standard 2.0 Data Link and recharge
for: Apple (tutti/all), Nokia, LG, Samsung, PSP, Blackberry, Sony, HTC, LGM, Huawei and all the mobile devices with
micro and mini USB socket. Cable length: 95 cm.

MINI MULTI CHARGER

30243

- CARICA BATTERIE PER APPARATI MULTIMEDIALI MOBILI, PER CASA, COMPUTER O PER AUTO
- MINI MULTI CHARGER FOR MOBILE DEVICES, SUITABLE AT HOME AS WELL AS AS IN THE CAR AND WITH PC
- CHARGEUR DE BATTERIE POUR VOITURE, MAISON, COMPUTER
- Batterieladegerät für Auto, Haus, Computer
- CARGADOR DE BATERÍA PARA EL COCHE, CASA, COMPUTER



VOLTAGGIO VOLTAGE 100V-240V / 12V

MASTER 96 INNER 12

USB: standard 2.0
In dotazione: trasformatore da rete 220V (100V-240V), presa accendisigari, cavo USB multiplo.
Lunghezza Cavo: 22 cm.

USB: standard 2.0
Included: 220 V wall transformer, (100V-240V), car lighter socket, Multiple USB cable.
Cable length: 22cm.

12V/24V - 220V



Compatibile con: iPhone (tutti), iPad (tutti), iPod (tutti), HTC, Blackberry, Nokia (presa mini) e tutti gli apparati dotati di Micro e Mini USB.

Suitable for: iPhone (all), iPad (all), iPod (all) HTC, Blackberry, Nokia (mini socket) and all the mobile devices with Micro and Mini USB socket.

USB CHARGE KIT

30242

- CARICA BATTERIE PER APPARATI MULTIMEDIALI MOBILI, PER CASA, COMPUTER O PER AUTO
- MINI MULTI CHARGER FOR MOBILE DEVICES, SUITABLE AT HOME AS WELL AS IN THE CAR
- CHARGEUR DE PORTABLE DE VOITURE 6 ADAPTEURS POUR DIFFÉRENTS MODÈLES
- Handy-Auflader für das Auto 6 Adapter für verschiedene Modelle
- CARGADOR DE MÓVIL PARA COCHE 6 ADAPTADORES PARA VARIOS MODELOS



ARROTOLABILE AUTOMATICAMENTE SELF ROLLING

MASTER 96 INNER 24

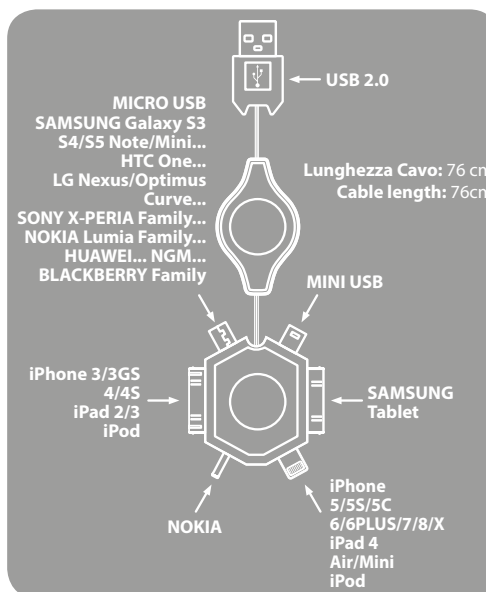

PORTA USB 12V/24V

30204

- PORTA USB AUTO CHARGER 12V/24V
- USB PORT AUTO CHARGER 12V/24V
- DOUBLE PORTE USB AUTO CHARGEUR
- Autoladegerät mit doppeltem Usb-Ausgang
- DOBLE PUERTA USB CARGADOR COCHE



MASTER 100 INNER 20

ADAPTER

12V/24V

30074

- ADATTATORE PER AUTO CON INTERRUTTORE PER SELEZIONARE IL VOLTAGGIO IN USCITA
- MOTORCAR ADAPTOR WITH SWITCH TO SELECT OUTPUT VOLTAGE
- ADAPTATEUR POUR VOITURE AVEC INTERRUPTEUR POUR LA SÉLECTION DU VOLTAGE EN SORTIE
- Adapter für das Auto mit einem Schalter zur Auswahl der sgehenden Spannung möglich zwischen
- ADAPTADOR PARA COCHE CON INTERRUPTOR PARA LA SELECCIÓN DE VOLTAJE EN SALIDA



MASTER 100 INNER 20

USB 10 IN 1



77052

- CAVO UNIVERSALE MULTIFUNZIONE DATI/RICARICA USB 10 IN 1
- UNIVERSAL CABLE MULTIFUNCTION DATA / CHARGING USB 10 IN 1
- CHARGEUR DE PORTABLE DE VOITURE 10 IN 1
- Handy-Auflader für das Auto 10 IN 1
- CARGADOR DE MOVIL PARA COCHE 10 IN 1



iPhone 3/3GS/4/4S
iPad 2/3 - iPod

SAMSUNG
SAMSUNG

10 in 1 USB charging cable
 Charge cable length: 18 cm



Apple iPhone

LG

SAMSUNG
SAMSUNG

SAMSUNG

- MICRO USB per SAMSUNG Galaxy S3/S4/S5 Note/Mini...
- HTC One...
- LG Nexus/Optimus/Curve...
- SONY X-PERIA Family...
- NOKIA Lumia Family...
- HUAWEI... NGM...
- BLACKBERRY Family ecc...

NOKIA

NOKIA

PSP

MINI USB

iPhone5/5S/5C - 6/6PLUS/7/8/X
iPad 4/Air/Mini - iPod

Adattatore USB accendisigari 5V-1A (DC 12/24V) **Apple iPhone**
 Cellulari-Navigatori-iPhone-iPad-iPod-Tablet-PC ecc...

NOKIA - LG - SAMSUNG - APPLE (tutti/all) - PSP - BLACKBERRY - SONY - HTC - NGM - HUAWEI ecc.



MASTER 96 INNER 24



USB CHARGE KIT

77054

- CAVO UNIVERSALE MULTIFUNZIONE DATI/RICARICA USB 10 IN 1
- UNIVERSAL CABLE MULTIFUNCTION DATA / CHARGING USB 10IN1
- CHARGEUR DE PORTABLE DE VOITURE 10 IN 1
- Handy-Auflader für das Auto 10 IN 1
- CARGADOR DE MOVIL PARA COCHE 10 IN 1



12V/24V

MASTER 96 INNER 12

Cellulari-Navigatori iPhone-iPad-iPod-Tablet-PC ecc...
NOKIA - LG - SAMSUNG - APPLE (tutti/all) - PSP - BLACKBERRY
SONY - HTC - NGM - HUAWAI ecc.

GOODYEAR



Cavo USB universale dati ed alimentazione per SmartPhones ed apparati multimediali mobili.
Cavo unico: pratico e comodo, permette di avere la presa corretta con un unico cavetto. USB: standard 2.0
Ricarica/Trasferisce dati: Apple (tutti/all), Nokia, LG, Samsung, PSP, Blackberry, Sony, HTC, NGM Huawei e tutti gli
apparati dotati di Micro e Mini USB. Lunghezza Cavo: 95 cm.

Universal USB power and data link, suitable for Smartphones, portable games and music devices.
All in one cable. Eliminates the hassle of multiple cables. USB: standard 2.0 Data Link and recharge
for: Apple (tutti/all), Nokia, LG, Samsung, PSP, Blackberry, Sony, HTC, LGM, Huawei and all the mobile devices with
micro and mini USB socket. Cable length: 95 cm.

MINI MULTI CHARGER

77053

- CARICA BATTERIE PER APPARATI MULTIMEDIALI MOBILI, PER CASA, COMPUTER O PER AUTO
- MINI MULTI CHARGER FOR MOBILE DEVICES, SUITABLE AT HOME AS WELL AS AS IN THE CAR AND WITH PC
- CHARGEUR DE BATTERIE POUR VOITURE, MAISON, COMPUTER
- Batterieladegerät für Auto, Haus, Computer
- CARGADOR DE BATERÍA PARA EL COCHE, CASA, COMPUTER



**VOLTAGGIO
VOLTAGE
100V-240V / 12V**

MASTER 96 INNER 12

Compatibile con: iPhone (tutti), iPad (tutti), iPod (tutti), HTC, Blackberry, Nokia (presa mini) e tutti gli apparati dotati di Micro e Mini USB.

Suitable for: iPhone (all), iPad (all), iPod (all) HTC, Blackberry, Nokia (mini socket) and all the mobile devices with Micro and Mini USB socket.

GOODYEAR

12V/24V - 220V



USB: standard 2.0
In dotazione: trasformatore da rete 220V (100V-240V), presa accendisigari, cavo USB multiplo.
Lunghezza Cavo: 22 cm.

USB: standard 2.0
Included: 220 V wall transformer, (100V-240V), car lighter socket, Multiple USB cable.
Cable length: 22cm.

USB CHARGE KIT

77055

- CARICA BATTERIE PER APPARATI MULTIMEDIALI MOBILI, PER CASA, COMPUTER O PER AUTO
- MINI MULTI CHARGER FOR MOBILE DEVICES, SUITABLE AT HOME AS WELL AS IN THE CAR
- CHARGEUR DE PORTABLE DE VOITURE 6 ADAPTEURS POUR DIFFÉRENTS MODÈLES
- Handy-Auflader für das Auto 6 Adapter für verschiedene Modelle
- CARGADOR DE MÓVIL PARA COCHE 6 ADAPTADORES PARA VARIOS MODELOS



**ARROTOLABILE
AUTOMATICAMENTE
SELF ROLLING**

MASTER 96 INNER 24

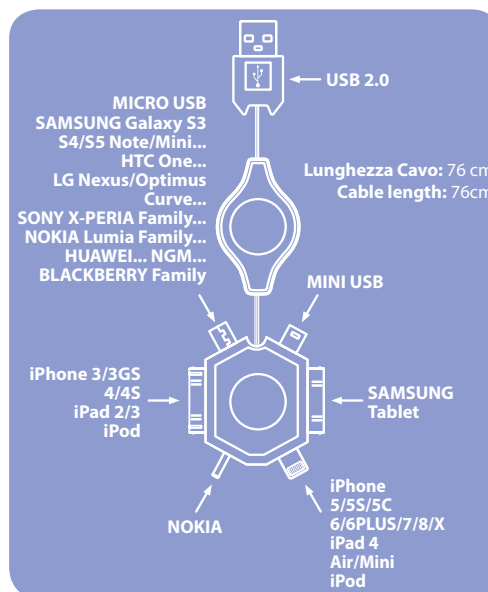

GOODYEAR



TWO-SOCKET

30077 - 12V/24V

- PRESE ACCENDISIGARI CON CAVO 12V/24V
- CIGARETTE LIGHTER PLUG WITH CABLE 12V/24V
- PRISE ALLUME-CIGARE AVEC CÂBLE 12V/24V
- Steckerbuchse für Zigarettanzünder mit Kabel 12V/24V
- TOMA ENCENDEADOR CON CABLE 12V/24V



MASTER 96 INNER 24

TWO-SOCKET

30076 - 12V/24V

- PRESE ACCENDISIGARI 12V/24V
- CIGARETTE LIGHTER PLUG 12V/24V
- PRISE ALLUME-CIGARE 12V/24V
- Steckerbuchse für Zigarettanzünder 12V/24V
- TOMA ENCENDEADOR 12V/24V



MASTER 96 INNER 24

PRESE ILLUMINATE PER FACILE LOCALIZZAZIONE AL BUIO ILLUMINATED SOCKETS FOR NIGHT TIME LOCATION
CAVO DIRITTO PER MAGGIORE PRATICITÀ STRAIGHT CABLE FOR TIDY USAGE
FISSAGGIO ANCHE CON VITI SCREW MOUNTING

THREE-SOCKET

30072 - 12V/24V

- PRESE ACCENDISIGARI CON CAVO 12V/24V
- CIGARETTE LIGHTER PLUG WITH CABLE 12V/24V
- PRISE ALLUME-CIGARE AVEC CÂBLE 12V/24V
- Steckerbuchse für Zigarettanzünder mit Kabel 12V/24V
- TOMA ENCENDEADOR CON CABLE 12V/24V



MASTER 96 INNER 24

PRESE ILLUMINATE PER FACILE LOCALIZZAZIONE AL BUIO ILLUMINATED SOCKETS FOR NIGHT TIME LOCATION
CAVO DIRITTO PER MAGGIORE PRATICITÀ STRAIGHT CABLE FOR TIDY USAGE
FISSAGGIO ANCHE CON VITI SCREW MOUNTING

FOUR-SOCKET

30071 - 12V/24V

- PRESE ACCENDISIGARI CON CAVO 12V/24V
- CIGARETTE LIGHTER PLUG WITH CABLE 12V/24V
- PRISE ALLUME-CIGARE AVEC CÂBLE 12V/24V
- Steckerbuchse für Zigarettanzünder mit Kabel 12V/24V
- TOMA ENCENDEADOR CON CABLE 12V/24V



MASTER 96 INNER 24

PRESE ILLUMINATE PER FACILE LOCALIZZAZIONE AL BUIO ILLUMINATED SOCKETS FOR NIGHT TIME LOCATION
CAVO DIRITTO PER MAGGIORE PRATICITÀ STRAIGHT CABLE FOR TIDY USAGE
FISSAGGIO ANCHE CON VITI SCREW MOUNTING

TROMBE BITONALI

30275

- KIT TROMBA + BOMBOLA A GAS, SUONO FORTE
- KIT OF HORN + GAS BOTTLE, STRONG SOUND
- KIT TROMPE+BOMBONE À GAS, SON FORT
- Bausatz Hupe + Gasflasche, Kraftvoller Sound
- KIT BOCINA+BOMBONA A GAS, SONIDO FUERTE



art. 30275
Kit tromba + bombola

30275 kit in blister MASTER 24

KIT ACCENDISIGARI

30085 - 12V/1,2W

- SPINOTTI E PRESE ACCENDISIGARI
 - ILLUMINATED CIGARETTE-LIGHTER SOCKET
 - PRISE ALLUME CIGARE 12V, LUMINEUX
 - Beleuchteter Zigarrenanzünder 12V
 - BASE ENCENDEADOR 12V ILUMINADA
- MASTER 144 INNER 12

Ø22 - foro-hole Ø28

disinnesto automatico

illuminata/illuminated



ACCENDISIGARI

30087 - 12V

- SPINOTTI E PRESE ACCENDISIGARI
 - ILLUMINATED CIGARETTE-LIGHTER SOCKET
 - PRISE ALLUME CIGARE 12V, LUMINEUX
 - Beleuchteter Zigarrenanzünder 12V
 - BASE ENCENDEADOR 12V ILUMINADA
- MASTER 144 INNER 12

Ø22 - illuminata/illuminated



ACCENDISIGARI

30096 - 12V

- SPINOTTI E PRESE ACCENDISIGARI
 - ILLUMINATED CIGARETTE-LIGHTER SOCKET
 - PRISE ALLUME CIGARE 12V, LUMINEUX
 - Beleuchteter Zigarrenanzünder 12V
 - BASE ENCENDEADOR 12V ILUMINADA
- MASTER 200 INNER 50

Ø20



KIT ACCENDISIGARI

30093 - 12V

- SPINOTTI E PRESE ACCENDISIGARI
 - ILLUMINATED CIGARETTE-LIGHTER SOCKET
 - PRISE ALLUME CIGARE 12V, LUMINEUX
 - Beleuchteter Zigarrenanzünder 12V
 - BASE ENCENDEADOR 12V ILUMINADA
- MASTER 200 INNER 50

Ø21 - illuminata/illuminated



SOCKET

30206 - 12V

- SPINOTTI E PRESE ACCENDISIGARI
 - ILLUMINATED CIGARETTE-LIGHTER SOCKET
 - PRISE ALLUME CIGARE 12V, LUMINEUX
 - Beleuchteter Zigarrenanzünder 12V
 - BASE ENCENDEADOR 12V ILUMINADA
- MASTER 72 INNER 12

Ø22 - con tappo/cup



VENTILATORE

30044 12V

- VENTILATORE
 - FAN
 - VENTILATEUR AVEC GRILLE EN MÉTAL
 - Ventilator
 - VENTILADOR
- MASTER 24 INNER 12



CAMPING 17 LED

30032

- LANTERNA CAMPING 17 LED
- CAMPING LANTERN 17 LED
- LANTERNE DE CAMPING 17 LEDS
- Camping-laterne 17 led (leuchtdiode)
- LINTERNA CAMPING 17 LED

- LEGGERA NON INGOMBRANTE UTILE IN AUTO, IN CASA IN CAMPEGGIO
- APPENDINO DI SICUREZZA
- IMPERMEABILE DA USO ESTERNO
- BUSSOLA DI ORIENTAMENTO
- PULSANTE ON/OFF CON 2 INTENSITÀ DI LUCE (7 LED E 17 LED)
- LIGHT, NOT CUMBERSOME, USEFUL IN THE CAR, AT HOME, WHILE CAMPING
- SAFETY HOOK
- IMPERMEABLE FOR EXTERNAL USE
- WITH COMPASS
- ON/OFF SWITCH WITH 2 LIGHT INTENSITIES (7 LED AND 17 LED)

with compass
bussola di orientamento



safety hook
appendino di sicurezza

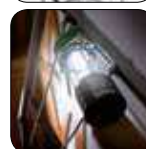

MASTER 36 INNER 12

LAMPADA 60 LED

30036 - 12V/220V

- LAMPADA DA LAVORO RICARICABILE 60 LED
- RECHARGEABLE WORK LIGHT 60 LED
- LAMPE DE BUREAU RECHARGEABLE 60 LED
- Aufladbare Aufladelampe 60 led
- LÁMPARA DE TRABAJO RECARGABLE 60 LED

RICARICABILE

UTILISSIMA IN AUTO, CAMPING, NAUTICA, EMERGENZA

MASTER 24 INNER 6

USED IN THE CAR WHEN CAMPING, SAILING, IN EMERGENCIES



LAMPADA NEON

30020 - 12V/8W

- LAMPADA 12V AL NEON FLUORESCENTE, CON CAVO LUNGO MT 5
- 12V FLUORESCENT NEON LAMP WITH MT 5 LONG CABLE
- LAMPE BALADEUSE NEON 12V FLUORESCENTE, AVEC MT 5 DE CABLE EN DOTATION
- Fluoreszierende 12V-Neonleuchte mit 5-Meter-Kabel
- LAMPARA 12V NEON FLUORESCENTE, CON MT 5 DE CABLE

CON BASE

MASTER 24



LAMPADA NEON

30024 - 12V/8W - 220V

- LAMPADA 12V AL NEON FLUORESCENTE, CON CAVO LUNGO MT 5
- 12V FLUORESCENT NEON LAMP WITH MT 5 LONG CABLE
- LAMPE BALADEUSE NEON 12V FLUORESCENTE, AVEC MT 5 DE CABLE EN DOTATION
- Fluoreszierende 12V-Neonleuchte mit 5-Meter-Kabel
- LAMPARA 12V NEON FLUORESCENTE, CON MT 5 DE CABLE

OMOLOGATA EN 60598-1/A1:2006

MASTER 24



REVOLVING

24051 - 12V

- LUCE SEGNALE VEICOLO IN MOVIMENTO 12V
- 12V REVOLVING LIGHT FOR VEHICLES IN MOTION
- GYROPHARE 12V DE SIGNALISATION VEHICULE EN MARCHÉ
- Warnleuchte für Fahrzeug in Bewegung 12V
- ROTATIVO MAGNETICO 12V. LÁMPARA 21W

MASTER 24



10 FUSIBILI BILAMA

30112

- CARTELLA DA 10 PZ. FUSIBILI BILAMA OMOLOGATI ASSORTITI
- CARD OF 10 ASSORTED HOMOLOGATED DOUBLE BLADE FUSES
- CARTE DE 10 PCS. FUSIBLES ENFICHABLES HOMOLOGUÉ ASSORTIS
- Tasche mit 10 st. Zugelassenen Bimetallsicherungen verschiedener Größen
- BLISTER DE 10 PZ. FUSIBLES BILAMA SURTIDOS HOMOLOGADOS



7.5A - 10A - 15A - 20A - 25A

MASTER 500 INNER 50

10 FUSIBILI MINI

30113

- CARTELLA DA 10 PZ. MINI FUSIBILI BILAMA OMOLOGATI
- CARD OF 10 HOMOLOGATED DOUBLE BLADE FUSES
- CARTE DE 10 PCS. FUSIBLES ENFICHABLES HOMOLOGUÉ ASSORTIS
- Tasche mit 10 st. Zugelassenen Bimetallsicherungen verschiedener Größen
- BLISTER DE 10 PZ. FUSIBLES BILAMA SURTIDOS HOMOLOGADOS



7.5A - 10A - 15A - 20A - 25A - 30A

MASTER 500 INNER 50

10 FUSIBILI CILINDRICI

30110

- CARTELLA DA 10 PZ. FUSIBILI CILINDRICI ASSORTITI
- CARD OF 10 ASSORTED CYLINDRIC FUSES
- CARTE DE 10 PCS. FUSIBLES STEATILES ASSORTIS
- Tasche mit 10 verschiedenen zylindrischen Sicherungen
- BLISTER DE 10 PZ. FUSIBLES CILINDRICOS SURTIDOS



2A - 5A - 8A - 16A - 25A

MASTER 500 INNER 50

SAFE-KIT 10PZ E TESTER

30121 - 6/12/24v

- KIT 10 PZ. FUSIBILI BILAMA E TESTER PER IMPIANTI A 6/12/24V
- KIT OF 10 PCS. DOUBLE BLADE FUSES AND TESTER FOR 6/12/24V
- 10 PCS. FUSIBLES ENFICHABLES ET TESTEUR POUR APPAREILS À 6/12/24V
- 10 bimetal-Sicherungen und Testgerät 6/12/24V für Elektro-Anlagen
- 10 PZ. FUSIBLES BILAMA Y TESTER PARA INSTALACIÓN A 6/12/24V



**3A - 5A - 7.5A - 10A - 15A - 20A
25A - 30A - TESTER**

MASTER 120 INNER 24

PARKING KIT

30270 - 12V

- KIT SENSORE DI PARCHEGGIO
- PARKING SENSOR KIT
- KIT CAPTEUR DE PARKING
- Kit Parksensoren
- KIT SENSOR DE APARCAMIENTO

- 1- contiene 2 sensori ultrasonici
- 2- display visivo di segnalazione da installare in auto
- 3- evita collisioni in fase di parcheggio con persone e cose
- 4- si posiziona sul retro dell'auto
- 5- 3 livelli di segnalazione con diversa intensità sonora e luminosa sul display in dotazione
- 6- facile montaggio con dettagliato libretto istruzioni all'interno

- 1- contains 2 ultrasound sensors
- 2- visual signalling display for installation in the car
- 3- avoid colliding with people or objects when parking
- 4- positioned on the back of the car
- 5- 3 signalling levels with different light and sound intensities on the display provided
- 6- easy assembly with detailed instruction booklet inside

MASTER 20 INNER 10

DISTANZA DI RILEVAZIONE

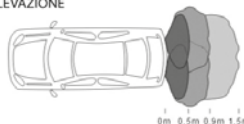

SCHEMA ELETTRICO

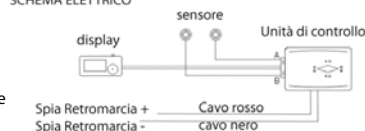

SCHEMA D'INSTALLAZIONE

Assicurarsi che nessun componente del veicolo si trovi nel raggio di azione del sistema di rilevazione.

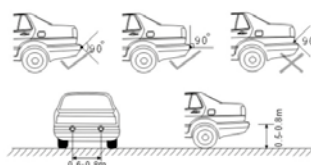

FASE	DISTANZA	MODALITÀ	SUONO
1	100 - 150 cm	SICUREZZA	Bi.Bi.Bi.
2	50 - 90 cm	ALLARME	BiBiBiBi
3	0 - 40 cm	PERICOLO	Biiiiiiiiiiii



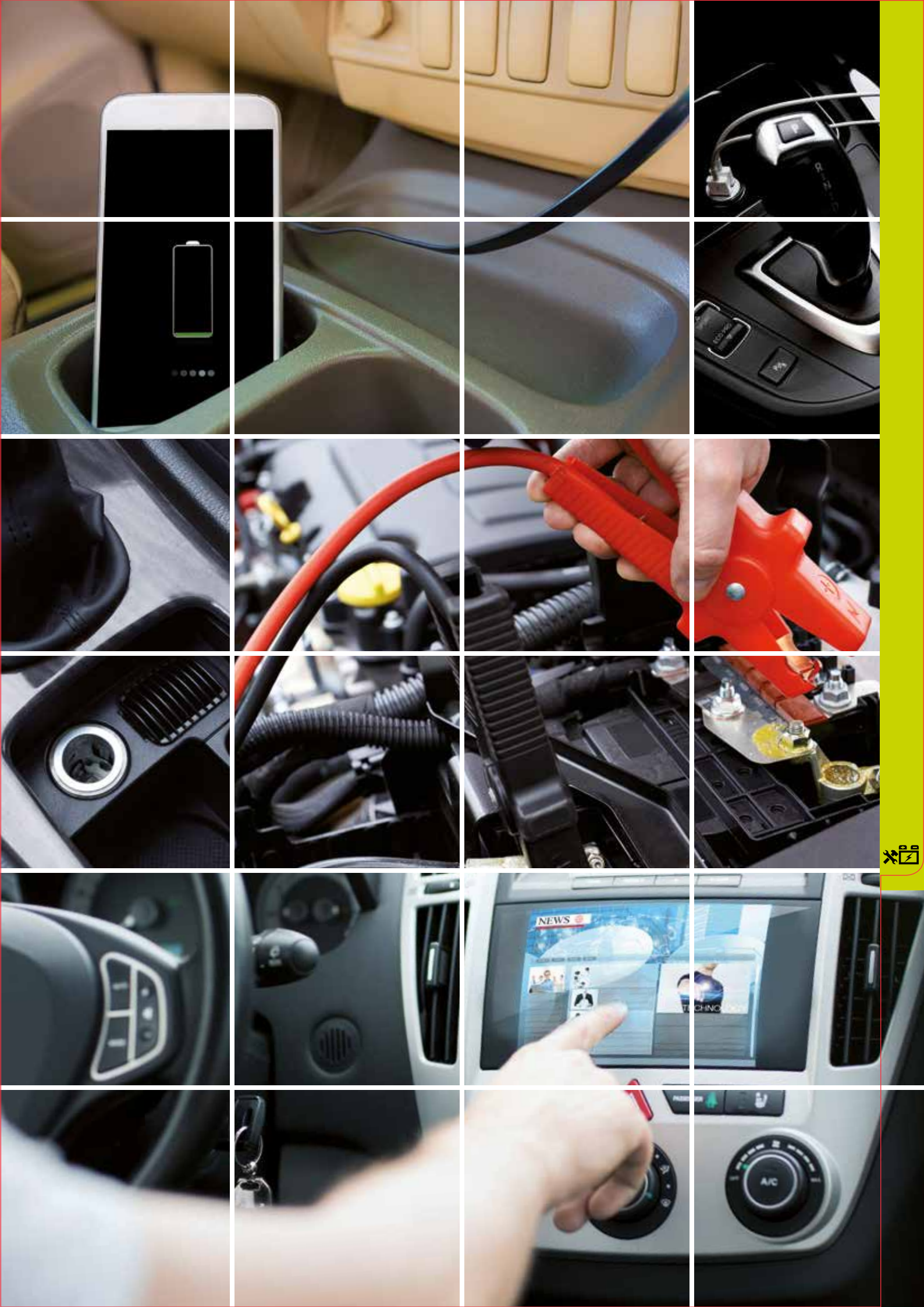



EMERGENZA - TENDINE E PARASOLI

EMERGENCY ITEMS

SUN SHADES - SUN CURTAINS

SUPPORTO VENDITA EMERGENZA - TENDINE E PARASOLI



www.Bottari.it
Bottari
ITALY





EMERGENZA TENDINE E PARASOLI

EMERGENCY ITEMS - SUN SHADES - SUN CURTAINS

EMERGENZA pag 296
TENDINE E PARASOLI pag 306



CAVI BATTERIA

28020

- CAVI BATTERIA 200A PROFESSIONALI Ø 8 MM-200 CM
- PROFESSIONAL 200A BATTERY CABLES Ø 8 MM-200 CM
- CABLE BATTERIE 200A PROFESSIONEL Ø 8 MM-200 CM
- Profi-Batteriekabel 200A Ø 8 mm-200 cm
- CABLE BATERIA 200A PROFESIONAL Ø 8 MM-200 CM

200 A

MASTER 24



CAVI BATTERIA

28021

- CAVI BATTERIA 200A PROFESSIONALI Ø 8 MM-200 CM
- PROFESSIONAL 200A BATTERY CABLES Ø 8 MM-200 CM
- CABLE BATTERIE 200A PROFESSIONEL Ø 8 MM-200 CM
- Profi-Batteriekabel 200A Ø 8 mm-200 cm
- CABLE BATERIA 200A PROFESIONAL Ø 8 MM-200 CM

200 A

MASTER 12 PACKAGING IN DOUBLE BLISTER



CAVI BATTERIA

28022

- CAVI BATTERIA 400A PROFESSIONALI Ø 10 MM-200 CM
- PROFESSIONAL 400A BATTERY CABLES Ø 10 MM-200 CM
- CABLE BATTERIE 400A PROFESSIONEL Ø 10 MM-200 CM
- Profi-Batteriekabel 400A Ø 10 mm-200 cm
- CABLE BATERIA 400A PROFESIONAL Ø 10 MM-200 CM



400 A

Ø 10 mm-200 cm

MASTER 12

CAVI BATTERIA

28024

- CAVI BATTERIA 400A PROFESSIONALI Ø 16 MM-250 CM
- PROFESSIONAL 400A BATTERY CABLES Ø 16 MM-250 CM
- CABLE BATTERIE 400A PROFESSIONEL Ø 16 MM-250 CM
- Profi-Batteriekabel 400A Ø 16 mm-250 cm
- CABLE BATERIA 400A PROFESIONAL Ø 16 MM-250 CM

**PER FURGONI
Ø 16 MM**



400 A

MASTER 12 IN CONTENITORE/SACCA CON ZIP RICHIUDIBILE

CAVI BATTERIA

28026

- CAVI BATTERIA 500A PROFESSIONALI Ø 25 MM-300 CM
- PROFESSIONAL 500A BATTERY CABLES Ø 25 MM-300 CM
- CABLE BATTERIE 500A PROFESSIONEL Ø 25 MM-300 CM
- Profi-Batteriekabel 500A Ø 25 mm-300cm
- CABLE BATERIA 500A PROFESIONAL Ø 25 MM-300 CM

**PER CAMION
Ø 25 MM**



500 A

MASTER 12 IN CONTENITORE/SACCA CON ZIP RICHIUDIBILE



CAVI BATTERIA

77340

- CAVI BATTERIA 200A PROFESSIONALI Ø 8 MM-200 CM
- PROFESSIONAL 200A BATTERY CABLES Ø 8 MM-200 CM
- CABLE BATTERIE 200A PROFESSIONEL Ø 8 MM-200 CM
- Profi-Batteriekabel 200A Ø 8 mm-200 cm
- CABLE BATERIA 200A PROFESIONAL Ø 8 MM-200 CM

GOODYEAR



200 A

MASTER 24

CAVI BATTERIA

77342

- CAVI BATTERIA 400A PROFESSIONALI Ø 10 MM-200 CM
- PROFESSIONAL 400A BATTERY CABLES Ø 10 MM-200 CM
- CABLE BATTERIE 400A PROFESSIONEL Ø 10 MM-200 CM
- Profi-Batteriekabel 400A Ø 10 mm-200 cm
- CABLE BATERIA 400A PROFESIONAL Ø 10 MM-200 CM

GOODYEAR



400 A

MASTER 12

CAVI BATTERIA

77344

- CAVI BATTERIA 600A PROFESSIONALI Ø 25 MM-300 CM
- PROFESSIONAL 600A BATTERY CABLES Ø 25 MM-300 CM
- CABLE BATTERIE 600A PROFESSIONEL Ø 25 MM-300 CM
- Profi-Batteriekabel 600A Ø 25 MM-300 CM
- CABLE BATERIA 600A PROFESIONAL Ø 25 MM-300 CM

GOODYEAR



**PER CAMION
Ø 25 MM**

600 A

MASTER 12

BARRA TRAINO

28016

- BARRA TRAINO IN METALLO 2.000 KG
- STEEL TOW-ROPE 2.000 KG
- BARRE DE REMORQUE EN MÉTAL 2000 KG
- Zugstange aus Metall für 20 Doppelzentner
- BARRA ARRASTRE DE METAL 2000 KG



28016	zincata	186 cm	2000 Kg
-------	---------	--------	---------

MASTER 6

TRAINO CAR

28001-28004-28005

- CORDA TRAINO ELASTICA
- ELASTICIZED TOW ROPE
- CORDE ÉLASTIQUE POUR REMORQUE
- Elastisches Abschleppseil
- CUERDA REMOLQUE



28001	400 cm	2800 Kg	busta	MASTER 12
28004	400 cm	2100 Kg	busta	MASTER 12
28005	400 cm	2100 Kg	blister	MASTER 12

TRAINO CAR ACCIAIO

28009

- CORDA TRAINO 5 T
- TOW ROPE FOR UP TO 5 T
- CORDE POUR REMORQUE DE 5 T
- Abschleppseil 5 T
- CUERDA REMOLQUE 5 T



28009	400 cm	5000 Kg	ø 8 mm
-------	--------	---------	--------

MASTER 20

VENTOSA RIPARA CARROZZERIA

28080

- VENTOSA RIPARA CARROZZERIA
- SUCTION CUP REPAIRER BODYWORK
- VENTOUSE REPARATEUR DE LA CARROSSERIE
- Saugnapf Karosserie Reparationen
- VENTOSA REPARA-CARROCCERIA



MASTER 48 INNER 12



TESTER BATTERIA PROFESSIONAL

30094

- TESTER BATTERIA ATTACCO ACCENDISIGARI
- BATTERY TESTER WITH CIGARETTE LIGHTER PLUG
- TESTEUR BATTERIE POUR CONTROLLER L'ÉTAT DE RECHARGE DE LA BATTERIE AVEC PRISE ALLUME CIGARE
- Batterietestgerät für Anschluss an Zigarrenanzünder
- TESTER 12V BATERIA-REGULADOR-ALTERZADOR

12V

MASTER 100 INNER 25



CARTELLO CARICO SPORGENTE

28050

- CARTELLO CARICO SPORGENTE DOTATO DI 4 GEMME
- PROJECTING LOAD SIGN WITH 4 REFLECTORS
- PLAQUE DE SIGNALISATION AVEC 4 CATADIOPTRES EN DOTATION
- Schild vorstehende Ladung mit 4 Katzenaugen
- PLACA CARGA SOBRESALIENTE



MASTER 10

JOLLY TANK

28055 - 28056

- TANICA EMERGENZA 8 LITRI
- 8 LITRES EMERGENCY CAN
- JERRICAN DE SECOURS 8 LITRES
- 8-Liter-notkanister
- BIDÓN DE EMERGENCIA 8 LITROS



28055 - 8 LT. MASTER 125 SFUSO
 28056 - 8 LT. MASTER 100 IN BUSTA

ESTINTORE SPRAY

31520-35196

- ESTINTORE SPRAY ADATTO PER SPEGNERE PICCOLI FUOCHI
- SPRAY EXTINGUISHER

- EXTINGUEUR
- Feuerlöscher
- EXTINTOR

Viene utilizzato per domare gli incendi sulle auto, sulle barche, negli uffici, nelle case, ecc. Non è tossico, non è dannoso per l'ambiente e neanche macchiante. Può essere utilizzato per estinguere l'attrezzatura elettrica con voltaggio fino a 1000V dalla distanza di 1 metro.

31520	450 ml
35196	1000 ml

Ideal for extinguishing cars, boats, offices, houses, etc. Nontoxic, environment-friendly, stain-resistant. Can be used to extinguish fires, including electric equipment up to 1000V in distance 1 m.



1000 ml

MASTER 12



450 ml

MASTER 12

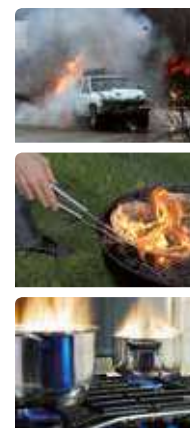

ESTINTORE FIRST AID FIRE

28086

- ESTINTORE OMOLOGATO RINA A/B/C DA 1 KG CON MANOMETRO
- FIRE EXTINGUISHER A/B/C RINA HOMOLOGATION. WEIGHT: 1 KG WITH MANOMETER
- EXTINGUEUR HOMOLOGUÉ RINA A/B/C 1 KG
- Zugelassener Feuerlöscher a/b/c-rina 1 kg
- EXTINTOR HOMOLOGADO A/B/C-RINA DE 1KG

1kg

OMOLOGATO

CON MANOMETRO - WITH MANOMETER

MASTER 6



TANICA METALLO

28057 - 28058 - 28059

- TANICA IN METALLO, OMOLOGATA
- METAL CAN, HOMOLOGATED
- JERRICAN, HOMOLOGUÉ
- Kanister, zulassung
- BIDÓN, HOMOLOGADA

OMOLOGATE

28057 - 20 LT. MASTER 4

28058 - 10 LT. MASTER 5

28059 - 5 LT. MASTER 8



art. 28057



art. 28058



art. 28059

TANICA IN PLASTICA

28067 - 28062 - 28061

- TANICA CON BECCUCCIO OMOLOGATA
- FUEL CAN WITH SPOUT, HOMOLOGATED
- JERRICAN AVEC BEC
- Kanister mit Stutzen
- BIDÓN CON BOQUILLA

OMOLOGATE

28067 - 20 LT. MASTER 10

28062 - 10 LT. MASTER 16

28061 - 5 LT. MASTER 25



art. 28067



art. 28062



art. 28061

ETILOMETRO CON PORTACHIAVI

28042

- ETILOMETRO CON PORTACHIAVI
- ALCOHOL BREATH TESTER
- ETHYLOMETRE
- Alkoholtestgerät
- ETILÓMETRO

CARATTERISTICHE

test alcolemico in 3 fasi
risposta ed esito rapido
catenella portachiavi
utilizzate 2 pile alcaline
AAA/um-4 da 1.5v non incluse

FEATURES

3step alcohol test
quick response and resume
key chain
use two 1.5v AAA/um-4 alkaline
batteries not included

MASTER 180 INNER 36



VALIGETTA PRONTO SOCCORSO

28034

- KIT VALIGETTA PRONTO SOCCORSO PER AUTO E FURGONI
- FIRST AID KIT FOR CARS AND TRUCKS
- KIT VALISE DE PREMIERS SECOURS POUR LES VOITURES ET LES CAMIONNETTES
- KIT Erste-Hilfe-Koffer zugelassen für Autos und Lieferwagen
- KIT MALETÍN DE PRIMEROS AUXILIOS PARA COCHE Y FURGONES

MASTER 24



KIT PRONTO SOCCORSO CON VELCRO

28039

- KIT PRONTO SOCCORSO CON VELCRO
- FIRST AID KIT FOR CARS AND TRUCKS
- KIT VALISE DE PREMIERS SECOURS
- KIT Erste-Hilfe-Koffer zugelassen
- KIT MALETÍN DE PRIMEROS AUXILIOS

OMOLOGAZIONE EUROPEA DIN 13164
EUROPEAN HOMOLOGATION DIN 13164

- 1X 160X210CM - COPERTA DI SOCCORSO - FIRST AID BLANKET
- 8X 10X6CM - CEROTTI ADESIVI - ADHESIVE DRESSING
- 3X 8X10CM - 1X 10X12CM - PACCHETTO MEDICAZIONE STERILE
FIRST AID DRESSING STERILE
- 2X 136X96X96CM - TRIANGOLO BENDAGGIO - TRIANGULAR BANDAGE
GRANDE-LARGE
- 2 PAIA GUANTI MONOUSO - 2 PAIRS DISPOSABLE GLOVES
- 1X 5MTX2,5CM - CEROTTO ADESIVO - ADHESIVE TAPE
- 3X 10X10CM - COMPRESSE STERILI DI TNT - WOUND COMPRESS STERILE
- 1X 60X80CM - 2X 40X60CM - TELO STERILE MEDICAZIONE USTIONI
BURN DRESSING STERILE
- 3X 8X4CM - 2X 6X4CM - BENDA DI GARZA ELASTICA - ELASTI BANDAG



MASTER 36 INNER 12

CARICA BATTERIA ENERGY 6A

28106

- CARICA BATTERIA. PROTEZIONE CONTRO SURRISCALDAMENTO
- BATTERY CHARGER. PROTECTION AGAINST THERMAL OVERLOAD
- CHARGEURS DE BATTERIE
- Batterie ladegerate
- CARGADOR DE BATERÍAS

6A

12V - 230V

MASTER 12

6 AMPERE



MORSETTO STACCA BATTERIA

24113

- MORSETTO STACCA BATTERIA
- AUTO DC POWER REGULATED ADAPTOR
- BORNE D'ISOLATION BATTERIE
- Batterieausschaltungsklemme
- BORNE CONECTOR DE BATERIA

Avvitando si attiva il collegamento, svitando si stacca il collegamento
 Funzione anti furto. Connettere al polo positivo (+)

You screw, battery is working, you unscrew, battery is not working. Anti-theft function. Connect to positive pole (+)

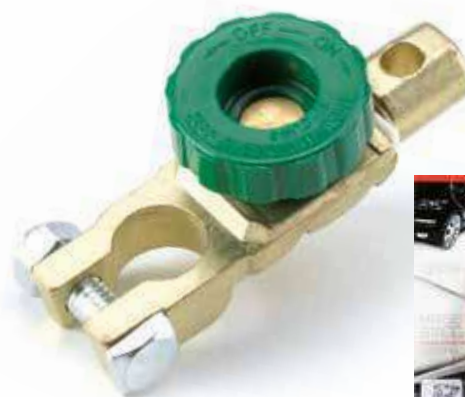

**SALVA LA BATTERIA
 FUNGE ANCHE DA ANTIFURTO**

MASTER 96 INNER 12

MORSETTI STACCA BATTERIA 6/12V

24117 - 24118 - 24119

- COPPIA MORSETTI BATTERIA
- COUPLE OF BATTERY TERMINALS
- LOT DE DEUX BORNES BATTERIE
- Satz Batterieklennen
- JUEGO BORNES BATERÍA



art. 24117 - STAR



art. 24118 - STANDARD



art. 24119 - DELUXE

24117	MASTER 96	INNER 12
24118	MASTER 96	INNER 12
24119	MASTER 96	INNER 12



SUPER RAPID

28031-28076-28077

- SIGILLANTE Istantaneo
- INSTANT GLUE
- COLLE SUPER RAPID
- Schnell-Dichtmasse
- PEGAMENTO Istantaneo
- CERAMICA - PORCELLANA
- ACCIAIO - GOMMA - CUOIO
- LEGNO - SUGHERO
- CARTA E CARTONE - PLASTICA
- CERAMICS - PORCELAIN
- WOOD - CORK - PAPER
- CARDBOARD - PLASTIC
- ATTACCA IN 10 SECONDI
- ATTACKS IN 10 SECONDS

28031	1 PEZZO	3 gr
28076	2 PEZZI	3 gr
28077	3 PEZZI	3 gr



MASTER 288 INNER 24

GILET ALTA VISIBILITÀ

77371 - 77372

- GILET ALTA VISIBILITÀ DIN EN 471
- HIGH VISIBILITY JACKET. MADE FROM FLUORESCENT POLYESTER
- GILET DE SIGNALISATION RÉFLÉCHISSANT, HAUTE VISIBILITÉ
- Sicherheitsweste
- CHALECO ALTA VISIBILIDAD

OMOLOGATO

DIN EN 471

77371		GIALLO	YELLOW
77372		ARANCIO	ORANGE



MASTER 96 INNER 24

TRIANGOLO OMOLOGATO

77370

- TRIANGOLO EMERGENZA OMOLOGATO
- HOMOLOGATED EMERGENCY WARNING TRIANGLE
- TRIANGLE D'URGENCE
- Pannendreieck
- TRIANGULO EMERGENCIA



OMOLOGATO

1 PC



MASTER 48





PARASOLE

77456

- PARASOLE RINFORZATO, IN MATERIALE ANTI UV ED ATERMICO, CON SUPERFICIE AD EFFETTO ALLUMINIO RIFLETTENTE, CON VENTOSE
- REINFORCED SUNSHADE, IN ANTI UV AND ATERMIC MATERIAL, WITH REFLECTIVE ALUMINIUM EFFECT SURFACE, WITH SUCTION CUPS
- PARASOL RENFORCÉ, EN MATIÈRE ANTI UV ET ATERMIQUE, AVEC UNE SURFACE D'EFFET D'ALUMINIUM RÉFLÉCHISSANT, AVEC VENTOUSES
- Verstärkter Sonnenschutz, in Anti Uv und atermischem Material, mit reflektierender Aluminium Effektoberfläche, mit Saugnäpfen
- SOMBRILLA REFUERZO, EN MATERIAL ANTI UV Y ATERMICO, CON SUPERFICIE DE EFECTO ALUMINIO REFLECTANTE, CON VENTOSAS



1 PC

60x130cm

MASTER 24



Protegge e rinfresca l'interno della vostra auto. Blocca il 99% dei raggi UV-A e UV-B, nocivi. Prodotto con materiali di alta qualità per una maggiore durata. Realizzato in spugna isolante rivestita da una superficie riflettente.

Protects against the sun and keeps your car interiors cool. Stops 99% of UV-A and UV-B rays, dangerous for the health. Made with high quality materials for a longer life. Insulated foam beneath a reflective metallic surface.

PARASOLE LUXURY

77455 - 77460

- PARASOLE MICROFORATO CON ORLATURA IN TESSUTO E CHIUSURA VELCRO, IN MATERIALE ANTI UV ED ATERMICO, CON SUPERFICIE AD EFFETTO ALLUMINIO RIFLETTENTE, CON VENTOSE
- MESH MATERIAL SUNSHADE WITH VELCRO CLOSURE, IN ANTI UV AND ATERMIC MATERIAL, WITH REFLECTIVE ALUMINIUM EFFECT SURFACE, WITH SUCTION CUPS
- PARASOL MATÉRIEL DE MAILLE AVEC LA FERMETURE DE VELCRO, DANS ANTI UV ET MATERIAU ATERMIQUE, AVEC SURFACE D'EFFET D'ALUMINIUM RÉFLÉCHISSANT, AVEC VENTOUSES
- Mesh material Sonnenschirm mit Klettverschluss, in Anti Uv und atermische Materialien, mit reflektierender Aluminium-effekt-oberfläche, mit Saugnäpfen
- MALLA DE MALLA MATERIAL CON CIERRE DE VELCRO, EN ANTI UV Y MATERIAL ATÉRMICO, CON SUPERFICIE DE EFECTO ALUMINIO REFLECTANTE, CON VENTOSAS



TOP

1 PC

MASTER 24

77455	blu-blue	60 x 130 cm
77460	blu-blue	80 x 150 cm

Fissaggio con ventose
 Fixing by means of suction cups



PROTEGGI PARABREZZA ALASKA

77457

- TELO ANTIGHIACCIO/ANTINEVE PER PARABREZZA
- ANTI-ICE/ANTI-SNOW WINDSHIELD PROTECTOR
- ANTI-GEL/ANTI-BROUILLARD
- Frostschutz / Anti-Beschlag
- ANTICONGELANTE / ANTIVAHO

MASTER 40



**Protegge da GHIACCIO, BRINA, NEVE,
SOLE, RAGGI UV**

Protects against ICE, FROST, SNOW, SUN, UV RAYS

FORMATO MAXI 150 x 70 cm

GOODYEAR

ESPOSITORE



CONTIENE 40 PEZZI

**SEMPRE PULITO
365 GIORNI L'ANNO!**

**WINTER
APPROVED**



COPPIA TENDINE CALZA "SOCK"

77451

- COPPIA TENDINE LATERALI IN TESSUTO ELASTICO A RETE
- COUPLE OF ELASTIC SIDE BLACK CAR CURTAINS
- RIDEAUX LATÉRAUX EN TISSU ÉLASTIQUE
- Seitenvorhänge aus elastischem Netzstoff
- CORTINAS LATERALES EN TELA ELÁSTICA



50x88cm

2 PCS

ANTI-INSETTI

MASTER 48 INNER 12

GOODYEAR



PARASOLE HOLOGRAM

22165

- PARASOLE LAMINATO RIFLETTENTE AD EFFETTO SPECCHIATO OLOGRAFICO
- HOLOGRAPHIC MIRRORED SUNSHADE
- PARE-SOLEIL RÉFLÉCHISSANT
- Sonnenschirm Gespiegeltc
- SOMBRILLA CON ESPEJO



60x135cm

1 PC

DOUBLE FACE

MASTER 50



PARASOLE HOLOGRAM

MAXI

22166

- PARASOLE LAMINATO RIFLETTENTE AD EFFETTO SPECCHIATO OLOGRAFICO
- HOLOGRAPHIC MIRRORED SUNSHADE
- PARE-SOLEIL RÉFLÉCHISSANT
- Sonnenschirm Gespiegeltc
- SOMBRILLA CON ESPEJO



70x145cm

1 PC

DOUBLE FACE

MASTER 50



BLACK NET

22040 - 22041

- COPPIA TENDINE LATERALI IN TESSUTO A RETE CON VELCRO + 6 VENTOSE COLORE NERO
- COUPLE OF SIDE BLACK CAR CURTAINS EQUIPPED WITH STICKER AND 6 SUCTION CUPS
- LOT DE DEUX RIDEAUX LATÉRAUX EN TISSU NET AVEC VELCRO + 6 VENTOUSES COULEUR NOIR
- Satz seitlicher Vorhänge aus Gittergewebe mit Klettverschluss + 6 Saugtaschen, Farbe schwarz
- PAR CORTINILLAS LATERALES DE MALLA DE TELA CON VELCRO + 6 VENTOSAS COLOR NEGRO

22040	40 x 45 cm
22041	45 x 55 cm



2 PCS

MASTER 24



SPRINT

22051

- COPPIA TENDINE LATERALI
- COUPLE OF SIDE CURTAINS
- LOT DE DEUX RIDEAUX LATÉRAUX
- Satz seitlicher Vorhänge
- PAR CORTINILLAS LATERALES

Fissaggio con ventose
Fixing by with of suction cups



36x46cm

2 PCS

MASTER 100



FAST

22052

- TENDINA POSTERIORE O ANTERIORE
- REAR OR FRONT CURTAIN
- RIDEAU PARE-SOLEIL AVANT/ARRIÈRE
- Hinteres oder vorderes Rollo
- CORTINILLA POSTERIOR O ANTERIOR

Fissaggio con ventose
Fixing by with of suction cups



50x100cm

1 PC

MASTER 100



PROTEX

22135 - 22142 - 22143

- PARASOLE A DOPPIO STRATO CON MICRO BOLLE, IN MATERIALE ANTI UV ED ATERMICO, CON SUPERFICIE AD EFFETTO ALLUMINIO RIFLETTENTE, BICOLORE, CON VENTOSE
- DOUBLE LAYER MICRO BUBBLE SUNSHADE, IN ANTI UV AND ATERMIC MATERIAL, WITH REFLECTIVE ALUMINIUM EFFECT, BICOLOUR, WITH SUCTION CUPS
- PARASOL DOUBLE COUCHE AVEC MICRO BOLLE, DANS UN MATÉRIAU ANTI UV ET ATERMIQUE, AVEC SURFACE EFFET ALUMINIUM REFLECHISSANT, BICOLORE, AVEC VENTOUSES
- Doppelschicht Seite mit Micro Bolle, in Anti Uv und Attermaterial, mit oberfläche effekt Aluminium Reflective, Bicolor, mit Saugnäpfen
- DOBLE CAPA LATERAL CON MICRO BOLLE, EN MATERIAL ANTI UV Y ATERMICO, CON SUPERFICIE EFFECT ALUMINIUM REFLECTIVE, BICOLOUR, CON VENTOSAS



3 MISURE: MEDIA GRANDE E GIGANTE

MASTER 50

22135	assortiti-assorted	60 x 130 cm
22142	assortiti-assorted	80 x 150 cm
22143	assortiti-assorted	90 x 150 cm

BUBBLE

DOUBLE FACE



POLAR

22136

- PARASOLE RINFORZATO, IN MATERIALE ANTI UV ED ATERMICO, CON SUPERFICIE AD EFFETTO ALLUMINIO RIFLETTENTE, CON VENTOSE
- REINFORCED SUNSHADE, IN ANTI UV AND ATERMIC MATERIAL, WITH REFLECTIVE ALUMINIUM EFFECT SURFACE, WITH SUCTION CUPS
- PARASOL RENFORCE, EN MATERIAU ANTI UV ET ATERMIQUE, AVEC UNE SURFACE D'EFFET D'ALUMINIUM RÉFLÉCHISSANT, AVEC DES VENTOUSES
- Sonnenschirm Verstärkt, in Anti Uv und alternative Material, mit reflektierender Aluminium Effektoberfläche, mit Saugnäpfen
- SOMBRILLA REFUERZO, EN MATERIAL ANTI UV Y ALTERNATIVO, CON SUPERFICIE DE EFECTO ALUMINIUM REFLECTANTE, CON RETOÑOS



60 x 130 cm

MASTER 60

22136	60 x 130 cm
--------------	--------------------

LUCIDO



POLAR PREMIUM

22161 assortiti-assorted 70 x 145 cm

22161

OPACO

DOUBLE FACE

- PARASOLE RINFORZATO, IN MATERIALE ANTI UV ED ATERMICO, CON SUPERFICIE AD EFFETTO ALLUMINIO OPACO, CON VENTOSE
- REINFORCED SUNSHADE, IN ANTI UV AND ATERMIC MATERIAL, WITH MATT ALUMINIUM EFFECT, WITH SUCTION CUPS
- PARASOL RENFORCE, EN MATERIAU ANTI UV ET ATERMIQUEF, AVEC UNE SURFACE D'EFFET D'ALUMINIUM OPAQUE, AVEC DES VENTOUSES
- Sonnenschirm Verstärkt, in Anti Uv und Attermaterial, mit effektoberfläche opaque Aluminium, mit Saugnäpfen
- SOMBRILLA REFUERZO, EN MATERIAL ANTI UV Y ALTERNATIVO, CON SUPERFICIE DE EFECTO ALUMINIO OPACO, CON RETOÑOS



VENTOSE DI SICUREZZA
SAFE SUCTION CUPS

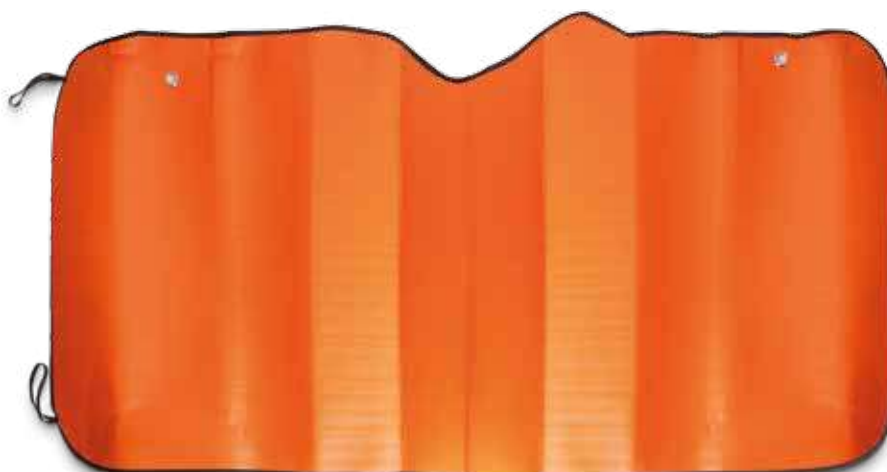

70 x 145 cm

MASTER 50

PROTEX PREMIUM

22163 assortiti-assorted 60 x 130 cm

22163

BUBBLE

OPACO

DOUBLE FACE

- PARASOLE A DOPPIO STRATO CON MICRO BOLLE, IN MATERIALE ANTI UV ED ATERMICO, CON SUPERFICIE AD EFFETTO ALLUMINIO OPACO, BICOLORE, CON VENTOSE
- DOUBLE LAYER MICRO BUBBLE SUNSHADE, IN ANTI UV AND ATERMIC MATERIAL, WITH MATT ALUMINIUM EFFECT, BICOLOUR, WITH SUCTION CUPS
- PARASOL DOUBLE COUCHE AVEC MICRO BOLLE, DANS UN MATÉRIAU ANTI UV ET ATERMIQUE, AVEC SURFACE EFFET ALUMINIUM OPAQUE, BICOLORE, AVEC VENTOUSES
- Doppelschicht Seite mit Micro Bolle, in Anti Uv und Attermaterial, mit oberfläche effekt Aluminium opaque, Bicolor, mit Saugnäpfen
- DOBLE CAPA LATERAL CON MICRO BOLLE, EN MATERIAL ANTI UV Y ATERMICO, CON SUPERFICIE EFFECT ALUMINIUM OPACO, BICOLOUR, CON VENTOSAS

VENTOSE DI SICUREZZA
SAFE SUCTION CUPS



60 x 130 cm

MASTER 50



PINK MESH

29301

- PARASOLE MICROFORATO CON ORLATURA IN TESSUTO E CHIUSURA VELCRO, IN MATERIALE ANTI UV ED ATERMICO, CON SUPERFICIE AD EFFETTO ALLUMINIO RIFLETTENTE, CON VENTOSE
- MESH MATERIAL SUNSHADE WITH VELCRO CLOSURE, IN ANTI UV AND A THERMIC MATERIAL, WITH REFLECTIVE ALUMINIUM EFFECT SURFACE, WITH SUCTION CUPS
- PARASOL MATÉRIEL DE MAILLE AVEC LA FERMETURE DE VELCRO, DANS ANTI UV ET MATERIAU A THERMIQUE, AVEC SURFACE D'EFFET D'ALUMINIUM REFLECHISSANT, AVEC VENTOUSES
- Smesh material Sonnenschirm mit Klettverschluss, in Anti Uv und athermische Materialien, mit reflektierender Aluminium-effekt-oberfläche, mit Saugnäpfen
- MALLA DE MALLA MATERIAL CON CIERRE DE VELCRO, EN ANTI UV Y MATERIAL ATÉRMICO, CON SUPERFICIE DE EFECTO ALUMINIO REFLECTANTE, CON VENTOSAS



**VENTOSE DI SICUREZZA
SAFE SUCTION CUPS**

80x150cm TOP

29301 rosa-pink 80 x 150 cm

MASTER 24

PARASOLE

21807

- PARASOLE ATERMICO E ANTI UV, CON GRAFICA DISNEY
- A THERMIC AND ANTI-UV SUNSHADE, WITH DISNEY GRAPHIC
- PARASOL A THERMIQUE ET ANTI-UV, AVEC DISNEY GRAPHIC
- Sathermischer und Anti-Uv Sonnenschutz, mit Disney Grafik
- SOMBRILLA A THERMIC Y ANTI-UV, CON DISNEY GRAPHIC

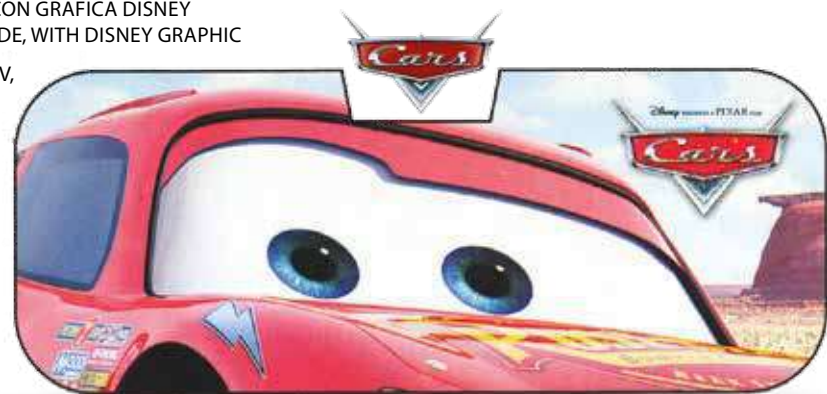

**VENTOSE DI SICUREZZA
SAFE SUCTION CUPS**

1 PC

60x145cm

MASTER 24 INNER 12

PARASOLE

21894

- PARASOLE ATERMICO E ANTI UV, CON GRAFICA DISNEY
- A THERMIC AND ANTI-UV SUNSHADE, WITH DISNEY GRAPHIC
- PARASOL A THERMIQUE ET ANTI-UV, AVEC DISNEY GRAPHIC
- Sathermischer und Anti-Uv Sonnenschutz, mit Disney Grafik
- SOMBRILLA A THERMIC Y ANTI-UV, CON DISNEY GRAPHIC



**VENTOSE DI SICUREZZA
SAFE SUCTION CUPS**

1 PC

60x145cm

MASTER 24 INNER 12

CUSCINO

21950

- CUSCINO ANATOMICO DA VIAGGIO (PER ZONA CERVICALE)
- HEAD REST PILLOW (FOR CERVICAL)
- REPOSE TÊTE ANATOMIQUE POUR VOYAGE (POUR LA ZONE CERVICALE)
- Anatomisches Reisekissen (für den Nackenbereich)
- COJIN ANATOMICO DE VIAJE (PARA ZONA CERVICAL)



MASTER 48 INNER 12

AVVOLGICINTURA

21951 PRINCESS

- AVVOLGICINTURA
- SHOULDER PAD
- PROTÈGE CEINTURE
- Sicherheitsgurtpolster
- CUBRECINTURON



1PC

MASTER 48 INNER 6

AVVOLGICINTURA

21842 NEMO

- AVVOLGICINTURA
- SHOULDER PAD
- PROTÈGE CEINTURE
- Sicherheitsgurtpolster
- CUBRECINTURON



1PC

MASTER 48 INNER 6





ANTIFURTI E ANTENNE GUANTI DA LAVORO

ANTITHEFT & ANTENNAS - WORKING GLOVES

SUPPORTO VENDITA LINEA ANTIFURTI E ANTENNE GUANTI DA LAVORO



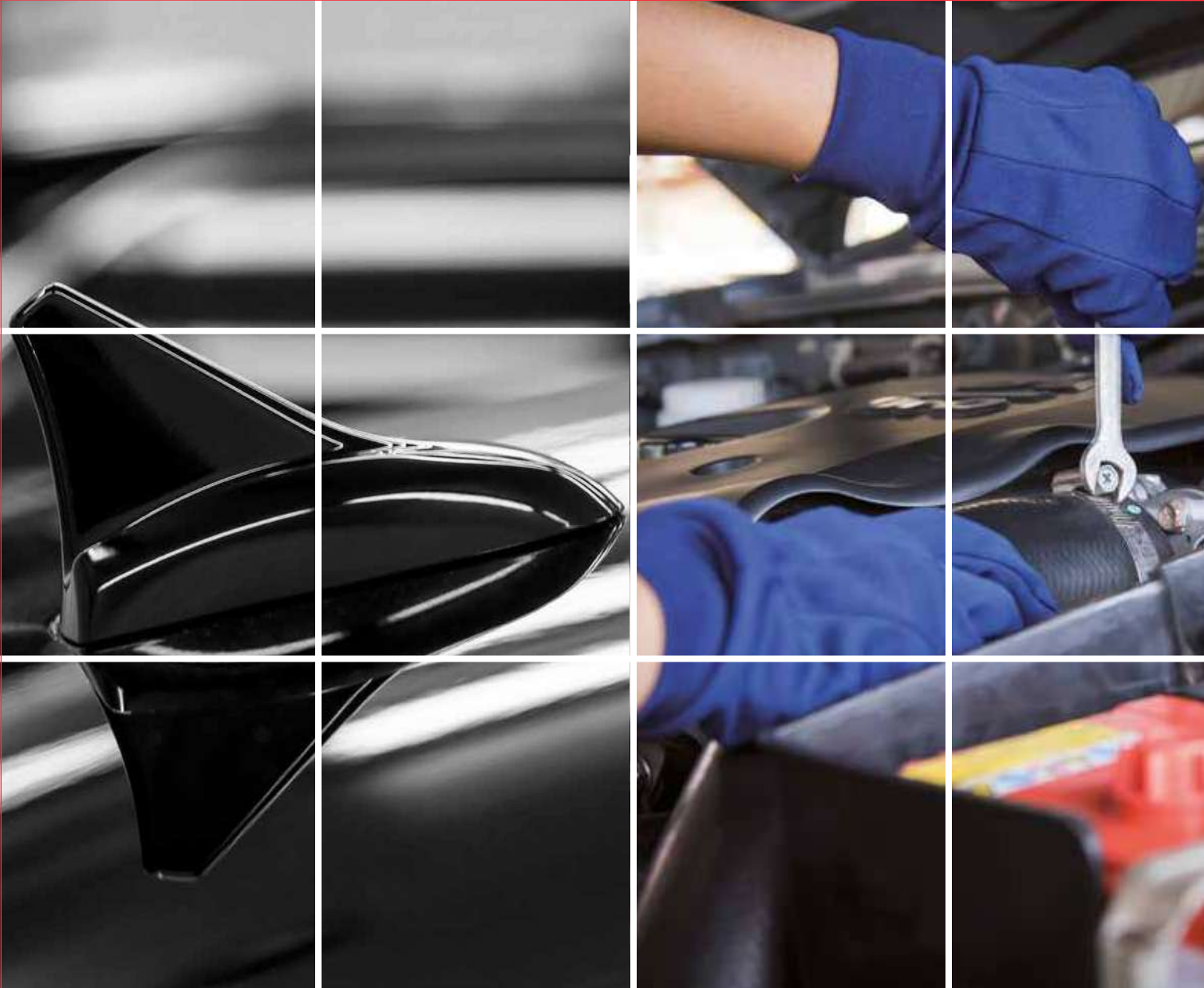

ANTIFURTI E ANTENNE GUANTI DA LAVORO

ANTITHEFT & ANTENNAS - WORKING GLOVES

ANTIFURTI E ANTENNE pag 316
GUANTI DA LAVORO pag 320



AUTOBLOCK

26002

- ASTA ANTIFURTO BLOCCA PEDALE E VOLANTE
- PEDAL AND STEERING WHEEL ANTI-THEFT LOCJING ROD
- CANNE ANTIVOL BLOQUE PEDAL ET VOLANT, EN ACIER ANTI-COUPÉ, UNIVERSEL
- Anti-Diebstahl Sperre, Blockiert Pedal Und Lenkrad
- BARRA ANTIRROBO BLOQUEA PEDAL Y VOLANTE

MASTER 12



**IN METALLO
DUE CHIAVI
IN DOTAZIONE**

UNMANUFACTURED
WITH STEEL
TWO KEYS SUPPLIED



ANTENNE AM/FM

18763-18764-18765-18766-18767

- RICAMBIO STELO PER ANTENNA AUTO
- SPARE AUTO ANTENNA SHAFT
- TIGE DE RECHANGE POUR ANTENNE AUTO
- Ersatzschaft Für Autoantenne
- RECAMBIO PERNO PARA ANTENA DE AUTOMÓVIL

MASTER 120 INNER 12





ANTENNA A TETTO

18744

- RICAMBIO STELO PER ANTENNA AUTO
- SPARE AUTO ANTENNA SHAFT
- TIGE DE RECHANGE POUR ANTENNE AUTO
- Ersatzschaft für Autoantenne
- RECAMBIO PERNO PARA ANTENA DE AUTOMÓVIL

24 CM

**UNIVERSALE
UNIVERSAL**

MASTER 144 INNER 12



ANTENNE

18708

- ANTENNA PER TETTO, LATERALE, STELO IN FIBERGLASS 60 CM
- ROOF OR SIDE ANTENNA WITH FIBERGLASS STEM 60 CM
- ANTENNE DE TOIT, LATERAL, TIGE EN FIBERGLASS 60 CM
- Dachantenne, Seitlich, Stab In Fiberglass 60 Cm
- ANTENA PARA TECHO, LATERAL, VARILLA DE FIBRA DE VIDRIO 60 CM

INDICATA PER CITROEN, PEUGEOT, RENAULT
SUITABLE FOR CITROEN, PEUGEOT, RENAULT

60 CM

IN FIBERGLASS

MASTER 48 INNER 12



ANTENNA PANDA

18741

- ANTENNA TELESCOPICA 2 ELEMENTI
- 2 SECTIONS TELESCOPIC ANTENNA
- ANTENNE TÉLESCOPIQUE 2 ELEMENTS
- Zweiteilige Teleskopantenne
- ANTENA TELESCOPICA 2 ELEMENTOS



INDICATA PER FIAT PANDA E SEAT MARBELLA

SUITABLE FOR FIAT PANDA AND SEAT MARBELLA

MASTER 24 INNER 12



ANTENNA TEL3

18702

- ANTENNA NERA 4 ELEMENTI, INCLINAZIONE FISSA 57°
- BLACK ANTENNA WITH 4 SECTIONS, FIXED INCLINATION 57°
- ANTENNE NOIRE 4 ELEMENTS, INCLINAISON FIXE 57°
- VIERTEILIGE SCHWARZE ANTENNE MIT FESTEM NEIGUNGSWINKEL VON 57°
- ANTENA NEGRA 4 ELEMENTOS, INCLINACIÓN FIJA 57°

INDICATA PER ALFA ROMEO, CITROEN, PEUGEOT, VOLKSWAGEN, SKODA
SUITABLE FOR ALFA ROMEO, CITROEN, PEUGEOT, VOLKSWAGEN, SKODA

MASTER 48 INNER 12



ANTENNA TETTO

18709

- ANTENNA 45°, IN FIBERGLASS 40 CM
- 45° FIBERGLASS ANTENNA 40 CM
- ANTENNE 45°, EN FIBERGLASS 40 CM
- Dachantenne 45°, Aus Fiberglass 40 Cm
- ANTENA 45°, DE FIBRA DE VIDRIO 40 CM

INDICATA PER VW, OPEL, AUDI
SUITABLE FOR VW, OPEL, AUDI

40 CM

IN FIBERGLASS

MASTER 48 INNER 12



ANTENNA TETTO

18712

- ANTENNA UNIVERSALE, REGOLABILE 0°-50°, CON STELO DI 7 CM CROMATO NERO
- ADJUSTABLE 0°-50° FIBREGLASS ANTENNA, WITH 7 CM BLACK CHROMED STEM
- ANTENNE UNIVERSELLE, REGLABLE 0°-50°, AVEC TIGE DE 7 CM CHROMÉ NOIRE
- Universalantenne, Einstellbar 0°-50°, mit 7 cm Langem Antennenstab, Schwarz-Verchromt
- ANTENA UNIVERSAL, REGULABLE 0°-50°, CON VARILLA DE 7 CM CROMADO NEGRO



7 CM **REGOLABILE 0°-50°**

MASTER 72 INNER 12

ANTENNA TETTO

18713

- ANTENNA UNIVERSALE, REGOLABILE 0°-50°, CON STELO IN PVC FLESSIBILE DI 14 CM
- ADJUSTABLE 0°-50° FIBREGLASS ANTENNA, WITH 14 CM FLEXIBLE PVC STEM
- ANTENNE UNIVERSELLE, REGLABLE 0°-50°, AVEC TIGE EN PVC FLEXIBLE DE 14 CM
- Universalantenne, Einstellbar 0°-50°, mit 14 cm Langem Antennenstab Aus Flexiblen Pvc
- ANTENA UNIVERSAL, REGULABLE 0°-50°, CON VARILLA EN PVC FLEXIBLE DE 14 CM



14 CM **REGOLABILE 0°-50°**

MASTER 72 INNER 12

CAVI PROLUNGA

18760

- PROLUNGA ANTENNA CM 350/450
- CABLE FOR ANTENNA CM 350/450
- PROLONGE ANTENNE CM 350/450
- Antennenverlängerung cm 350/450
- PROLONGACIÓN ANTENA CM 350/450



MASTER 120 INNER 12 **18760 - 450 cm**

ANTENNA

18711

- ANTENNA UNIVERSALE, REGOLABILE 0°-50°, CON STELO DI 60 CM CROMATO NERO
- ADJUSTABLE 0°-50° FIBREGLASS ANTENNA, WITH 60 CM BLACK CROMED STEM
- ANTENNE UNIVERSELLE, REGLABLE 0°-50°, AVEC TIGE DE 60 CM CHROMÉ NOIRE
- Universalantenne, Einstellbar 0°-50°, mit 60 cm Langem Antennenstab Schwarz-Verchromt
- ANTENA UNIVERSAL, REGULABLE 0°-50°, CON VARILLA DE 60 CM CROMADO NEGRO



60 CM **IN FIBERGLASS**
REGOLABILE 0°-50°

MASTER 48 INNER 12

ANTENNA

18731

- ANTENNA REGOLABILE 0°-50°, CON STELO CROMATO NERO DI 60 CM
- ADJUSTABLE 0°-50° ANTENNA WITH 60 CM BLACK CHROMED STEM
- ANTENNE REGLABLE 0°-50°, AVEC TIGE CHROMÉE NOIRE DE CM 60
- Antenne, Einstellbar 0°-50°, mit 60 cm Langem Antennenstab, Schwarz-Verchromt
- ANTENA REGULABLE 0°-50°, CON VARILLA CROMADO NEGRO DE CM 60

INDICATE PER LANCIA, FIAT, ALFA ROMEO
CON PREDISPOSIZIONE
SUITABLE FOR LANCIA, FIAT, ALFA ROMEO
WITH PREPARATION

60 CM **IN FIBERGLASS**
REGOLABILE 0°-50°

MASTER 48 INNER 12



ANTENNA

18732

- ANTENNA REGOLABILE 0°-50°, CON STELO IN FIBERGLASS DI CM 36
- ADJUSTABLE 0°-50° ANTENNA, WITH CM 36 FIBREGLASS STEM
- ANTENNE REGLABLE 0°-50°, AVEC TIGE EN FIBREGLASS DE CM 36
- Antenne, Einstellbar 0°-50°, mit cm 36 Langem Fiberglass-Antennenstab
- ANTENA REGULABLE 0°-50°, CON VARILLA DE FIBRA DE VIDRIO, DE CM 36

INDICATE PER LANCIA, FIAT, ALFA ROMEO
CON PREDISPOSIZIONE
SUITABLE FOR LANCIA, FIAT, ALFA ROMEO
WITH PREPARATION

36 CM **IN FIBERGLASS**
REGOLABILE 0°-50°

MASTER 72 INNER 12



RADAR

15065-15068

- ANTENNA IN ALLUMINIO
- ALUMINIUM ANTENNA
- ANTENNE ALUMINIUM
- Aluminium Antenne
- ANTENA EN ALUMINIO



MASTER 60 INNER 12

15065		nero	black
15068		cromato	chromed



**9 cm
aluminium
style**



WAVE

LUNGHEZZA 16 CM - LENGHT 16 CM

15069-15072

- ANTENNA IN ALLUMINIO
- ALUMINIUM ANTENNA
- ANTENNE ALUMINIUM
- Aluminium Antenne
- ANTENA EN ALUMINIO



MASTER 60 INNER 12

15069		nero	black
15072		cromato	chromed



**16 cm
aluminium
style**



GUANTI DA LAVORO IN NYLON E NITRILE

24200

- GUANTI DA LAVORO IN NYLON E NITRILE
- 1 PAIR WORKING GLOVES NYLON/NITRILE



- GANTS DE TRAVAIL
- Arbeitshandschuhe
- GUANTES DE TRABAJO

OTTIMA PRESA ANTISCIVOLO



MASTER 144 INNER 12

Leggeri e sensibili, traspiranti, garantiscono precisione nei lavori ed ottimo confort. Resistono agli oli. Ottimo grip liscio, lavabili e durevoli. Polsino elastico. Ideali per uso automotive, giardinaggio, edilizia, pittura, stampa, logistica, manutenzione, hobby, lavori di montaggio...

Lightweight and sensible, transpiring, with good confort and work precision. Oil resistant. Good grip, washable and long lasting. elasticated cuff. Suitable for automotive, painting, printing, construction, logistics, gardening, maintenance, hobbies, assembly operations...



GUANTI DA LAVORO IN JERSEY E NITRILE

24203

- GUANTI DA LAVORO IN JERSEY E NITRILE
- 1 PAIR WORKING GLOVES JERSEY/NITRILE



- GANTS DE TRAVAIL
- Arbeitshandschuhe
- GUANTES DE TRABAJO

SUPER ROBUSTI



MASTER 144 INNER 12

Super Robusti, ricoperti integralmente. Resistono agli oli. Ottimo grip liscio. Lavabili e durevoli. Polsino elastico. Ideali per uso automotive, giardinaggio, edilizia, pittura, stampa, logistica, manutenzione, hobby, lavori di montaggio.

Heavy Duty, fully coated. Oil resistant. Good grip, washable and long lasting. Elasticated Cuff.

Suitable for automotive, painting, printing, construction, logistics, gardening, maintenance, hobbies, assembly operations.



GUANTI DA LAVORO IN NYLON E PVC

24208

- GUANTI DA LAVORO IN NYLON E PVC
- 1 PAIR WORKING GLOVES NYLON/PVC



- GANTS DE TRAVAIL
- Arbeitshandschuhe
- GUANTES DE TRABAJO

OTTIMO GRIP SUPER ROBUSTI



MASTER 144 INNER 12

Robusti e confortevoli. Ottimo grip su ambo i lati. Lavabili e durevoli. Polsino elastico.

Ideali per uso automotive, giardinaggio, edilizia, pittura, stampa, logistica, manutenzione, hobby, lavori di montaggio.

Durable and Comfortable. Elasticated cuff. Good grip, washable and long lasting. Adjustable Velcro Cuff.

Suitable for automotive, painting, printing, construction, logistics, gardening, maintenance, hobbies, assembly operations.



NITRILE MONOUSO

98131 SMALL

98132 MEDIUM

98133 LARGE

- 100 GUANTI MONOUSO IN NITRILE
- 100 DISPOSABLE NITRILE GLOVES BOX
- GANTS DE TRAVAIL
- Arbeitshandschuhe
- GUANTES DE TRABAJO



100 Pezzi/Pcs			EPAL 80 x 120
Pezzi per ctn	Dim. Prodotto	Dimensioni ctn	Volume Ctn
Pcs per ctn	Product Size	Carton Size mm	m3
10	215 x 120 x 70	360 x 245 x 225	0,02

INFORMAZIONI TECNICHE - TECHNICAL SPECIFICATIONS			
Ctn per strato	Strati per pallet	ctn per pallet	altez/height
ctns per layer	layers per pallet	ctns per pallet	pallet
10	8	80	195 cm

SENZA TALCO/POWDER FREE

LATTICE NATURALE

98101 SMALL

98102 MEDIUM

98103 LARGE

- 100 GUANTI MONOUSO TALCATI IN LATTICE NATURALE AQL 1.5 IN BOX
- 100 POWDERED DISPOSABLE LATEX GLOVES AQL 1.5 BOX
- GANTS DE TRAVAIL
- Arbeitshandschuhe
- GUANTES DE TRABAJO



100 Pezzi/Pcs			EPAL 80 x 120
Pezzi per ctn	Dim. Prodotto	Dimensioni ctn	Volume Ctn
Pcs per ctn	Product Size	Carton Size mm	m3
10	215 x 120 x 70	360 x 245 x 225	0,02

INFORMAZIONI TECNICHE - TECHNICAL SPECIFICATIONS			
Ctn per strato	Strati per pallet	ctn per pallet	altez/height
ctns per layer	layers per pallet	ctns per pallet	pallet
10	8	80	195 cm

FINEMENTE TALCATI/LIGHTLY POWDERED

VINILE SENZA TALCO

98124 SMALL

98125 MEDIUM

98126 LARGE

- 100 GUANTI MONOUSO SENZA TALCO IN VINILE IN BOX
- 100 DISPOSABLE POWDERED FREE VINYL GLOVES
- GANTS DE TRAVAIL
- Arbeitshandschuhe
- GUANTES DE TRABAJO

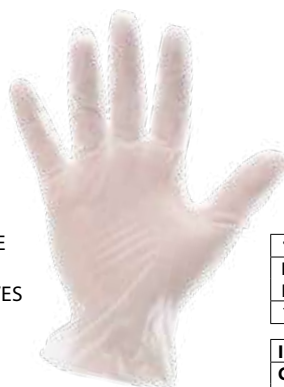

100 Pezzi/Pcs			EPAL 80 x 120
Pezzi per ctn	Dim. Prodotto	Dimensioni ctn	Volume Ctn
Pcs per ctn	Product Size	Carton Size mm	m3
10	215 x 120 x 70	360 x 245 x 225	0,02

INFORMAZIONI TECNICHE - TECHNICAL SPECIFICATIONS			
Ctn per strato	Strati per pallet	ctn per pallet	altez/height
ctns per layer	layers per pallet	ctns per pallet	pallet
10	8	80	195 cm

SENZA TALCO/POWDER FREE





REVOLUTION GIRL REVOLUTION ACCESSORIES

SUPPORTO VENDITA REVOLUTION GIRL REVOLUTION ACCESSORIES



www.Bottari.it
Bottari
ITALY





REVOLUTION GIRL REVOLUTION

REVOLUTION GIRL - REVOLUTION ACCESSORIES

REVOLUTION GIRL pag 324
REVOLUTION pag 336



MY SPRING FLOWER

29016 - 29017 - 29018

- COMPLETO FODERE AUTO 100% POLIESTERE
- SET SEAT CAR COVERS 100% POLYESTER
- JEU DE HOUSSES 100% POLYESTER
- Komplet Set Autositzbezüge 100% Polyester
- JUEGO FUNDA ASIENTO 100% POLIESTER

MASTER 6

29016		fiore rosa	pink flower
29017		fiore azzurro	blue flower
29018		fiore verde/rosso	green/red flower



SET COMPLETO:

- 2 COPRISIEDILI ANTERIORI
- 5 APPOGGIATESTA
- 2 POSTERIORI SEPARATI CON 3 ZIP

COMPLETE SET:

- 2 FRONT SEATS +5 HEAD RESTS
- 2 SEPARATE BACKS WITH 3 ZIP

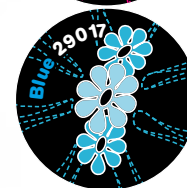

PACKAGING PVC BAG



5 cuffiette headrest covers

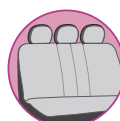

Zip System 1/2 1/3 2/3



AIR-BAG system



UNIVERSALE Universal



COLOUR system

MY SPRING FLOWER

29063 - 29064 - 29065

- COPRISIDILE IN TESSUTO
- SEAT CUSHION
- HOUSSE DE SIÈGE 100% POLYESTER
- Sitzbezüge 100% Polyester
- CUBREASIENTO EN TEJIDO 100% POLIESTER

29063		fiore rosa	pink flower
29064		fiore azzurro	blue flower
29065		fiore verde/rosso	green/red flower

MASTER 6



BORDATURA ELASTICA RINFORZATA IMBOTTITURA
REINFORCED ELASTIC EDGE QUILTING



PACKAGING PVC BAG



MY SPRING FLOWER

29115 - 29116 - 29117

- SET 4 PZ. TAPPETI MOQUETTE
- 4 PCS TEXTILE CAR MATS
- JEU DE TAPIS MOQUETTE
- 4 Stk Automatten
- 4 PZAS ALFOMBRAS MOQUETA

29115		fiore rosa	pink flower
29116		fiore azzurro	blue flower
29117		fiore verde/rosso	green/red flower



MASTER 6

MY SPRING FLOWER

29163 - 29164

- SET 2PZ AVVOLGICINTURE
- 2 PCS SHOULDER PADS
- PROTEGÈGE CEINTURES EN COTON
- Kugellager f. Sicherheitsgurtaufroller
- CUBRECINTURON



29163		fiore rosa	pink flower
29164		fiore azzurro	blue flower



MASTER 24



MY SPRING FLOWER

29213 - 29214

- COPRIVOLANTE
- STEERING WHEEL COVER
- COUVRE-VOLANT
- Lenkradbezug
- FUNDA VOLANTE

29213		fiore rosa	pink flower
29214		fiore azzurro	blue flower

Ø 38 cm



MASTER 12

MY STAR

29013 - 29014 - 29015

- COMPLETO FODERE AUTO 100% POLIESTERE
- SET SEAT CAR COVERS 100% POLYESTER
- JEU DE HOUSSES 100% POLYESTER
- Komplet Set Autositzbezüge 100% Polyester
- JUEGO FUNDA ASIENTO 100% POLIESTER

MASTER 6

29013		fiore rosa	pink flower
29014		fiore azzurro	blue flower
29015		fiore verde/viola	green/violet flower



SET COMPLETO:

- 2 COPRISIEDILI ANTERIORI
- 5 APPOGGIATESTA
- 2 POSTERIORI SEPARATI CON 3 ZIP

COMPLETE SET:

- 2 FRONT SEATS +5 HEAD RESTS
- 2 SEPARATE BACKS WITH 3 ZIP



PACKAGING
PVC BAG



5 cuffiette
headrest covers

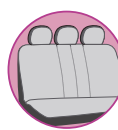

Zip System
1/2 1/3 2/3



AIR-BAG
system



UNIVERSALE
Universal



COLOUR
system

MY STAR

29060 - 29061 - 29062

- COPRISIDILE IN TESSUTO
- SEAT CUSHION
- HOUSSE DE SIÈGE 100% POLYESTER
- Sitzbezüge 100% Polyester
- CUBREASIENTO EN TEJIDO 100% POLIESTER

29060		fiore rosa	pink flower
29061		fiore azzurro	blue flower
29062		fiore verde/viola	green/violet flower

MASTER 6



BORDATURA ELASTICA RINFORZATA IMBOTTITURA

REINFORCED ELASTIC EDGE QUILTING



PACKAGING
PVC BAG



MY STAR

29112 - 29113 - 29114

- SET 4 PZ. TAPPETI MOQUETTE
- 4 PCS TEXTILE CAR MATS
- JEU DE TAPIS MOQUETTE
- 4 Stk Automatten
- 4 PZAS ALFOMBRAS MOQUETA

29112		fiore rosa	pink flower
29113		fiore azzurro	blue flower
29114		fiore verde/viola	green/violet flower



MASTER 6

MY STAR

29160 - 29161

- SET 2PZ AVVOLGICINTURE
- 2 PCS SHOULDER PADS
- PROTEGÈGE CEINTURES EN COTON
- Kugellager f. Sicherheitsgurtaaufroller
- CUBRECINTURON



29160		fiore rosa	pink flower
29161		fiore azzurro	blue flower



MASTER 24



MY STAR

29210 - 29211

- COPRIVOLANTE
- STEERING WHEEL COVER
- COUVRE-VOLANT
- Lenkradbezug
- FUNDA VOLANTE

29210		fiore rosa	pink flower
29211		fiore azzurro	blue flower

Ø 38 cm



MASTER 12

MY FLOWER SWIVEL

29010 - 29011 - 29012

- COMPLETO FODERE AUTO 100% POLIESTERE
- SET SEAT CAR COVERS 100% POLYESTER
- JEU DE HOUSSES 100% POLYESTER
- Komplet Set Autositzbezüge 100% Polyester
- JUEGO FUNDA ASIENTO 100% POLIESTER

MASTER 6

29010		fiore rosa	pink flower
29011		fiore azzurro	blue flower
29012		fiore verde/viola	green/violet flower



SET COMPLETO:
2 COPRISEDILI ANTERIORI
5 APOGGIATESTA
2 POSTERIORI SEPARATI
CON 3 ZIP
COMPLETE SET:
2 FRONT SEATS +5 HEAD RESTS
2 SEPARATE BACKS WITH 3 ZIP



PACKAGING
PVC BAG



MY FLOWER SWIVEL

29057 - 29058 - 29059

- COPRISEDILE IN TESSUTO
- SEAT CUSHION
- HOUSSE DE SIÈGE 100% POLYESTER
- Sitzbezüge 100% Polyester
- CUBREASIENTO EN TEJIDO 100% POLIESTER

29057		fiore rosa	pink flower
29058		fiore azzurro	blue flower
29059		fiore verde/viola	green/violet flower

MASTER 6



BORDATURA ELASTICA RINFORZATA IMBOTTITURA
REINFORCED ELASTIC EDGE QUILTING



PACKAGING
PVC BAG



MY FLOWER SWIVEL

29109 - 29110 - 29111

29109		fiore rosa	pink flower
29110		fiore azzurro	blue flower
29111		fiore verde/viola	green/violet flower

- SET 4 PZ. TAPPETI MOQUETTE
- 4 PCS TEXTILE CAR MATS
- JEU DE TAPIS MOQUETTE
- 4 Stk Automatten
- 4 PZAS ALFOMBRAS MOQUETA



MASTER 6

MY FLOWER SWIVEL

29157 - 29158

- SET 2PZ AVVOLGICINTURE
- 2 PCS SHOULDER PADS
- PROTEGÈGE CEINTURES EN COTON
- Kugellager f. Sicherheitsgurtaufroller
- CUBRECINTURON



29157		fiore rosa	pink flower
29158		fiore azzurro	blue flower



MASTER 24



MY FLOWER SWIVEL

29207

- COPRIVOLANTE
- STEERING WHEEL COVER
- COUVRE-VOLANT
- Lenkradbezug
- FUNDA VOLANTE

29207		fiore rosa	pink flower
-------	--	------------	-------------

Ø 38 cm



MASTER 12

MY SWEET CAT

29019 - 29020

- COMPLETO FODERE AUTO 100% POLIESTERE
- SET SEAT CAR COVERS 100% POLYESTER
- JEU DE HOUSSES 100% POLYESTER
- Komplet Set Autositzbezüge 100% Polyester
- JUEGO FUNDA ASIENTO 100% POLIESTER

MASTER 6

29019		gattino bianco	white cat
29020		gattino rosa	pink cat



SET COMPLETO:

- 2 COPRISIEDILI ANTERIORI
- 5 APPOGGIATESTA
- 2 POSTERIORI SEPARATI
- CON 3 ZIP

COMPLETE SET:

- 2 FRONT SEATS +5 HEAD RESTS
- 2 SEPARATE BACKS WITH 3 ZIP



PACKAGING
PVC BAG



5 cuffiette
headrest covers

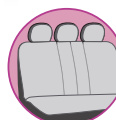

Zip System
1/2 1/3 2/3



AIR-BAG
system



UNIVERSALE
Universal



COLOUR
system

MY SWEET CAT

29066 - 29067

- COPRISIDILE IN TESSUTO
- SEAT CUSHION
- HOUSSE DE SIÈGE 100% POLYESTER
- Sitzbezüge 100% Polyester
- CUBREASIENTO EN TEJIDO 100% POLIESTER

29066		gattino bianco	white cat
29067		gattino rosa	pink cat

MASTER 6



BORDATURA ELASTICA RINFORZATA IMBOTTITURA

REINFORCED ELASTIC EDGE QUILTING



PACKAGING
PVC BAG

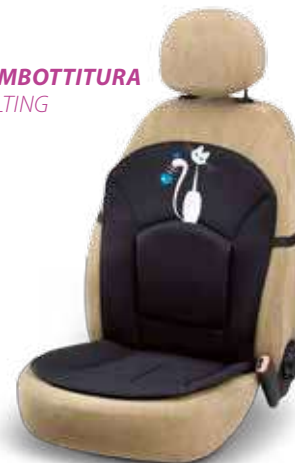

MY SWEET CAT

29118 - 29119

- SET 4 PZ. TAPPETI MOQUETTE
- 4 PCS TEXTILE CAR MATS
- JEU DE TAPIS MOQUETTE
- 4 Stk Automatten
- 4 PZAS ALFOMBRAS MOQUETA

29118		gattino bianco	white cat
29119		gattino rosa	pink cat



MASTER 6

MY SWEET CAT

29166 - 29167

- SET 2PZ AVVOLGICINTURE
- 2 PCS SHOULDER PADS
- PROTÈGE CEINTURES EN COTON
- Kugellager f. Sicherheitsgurtaufroller
- CUBRECINTURON



29166		gattino bianco	white cat
29167		gattino rosa	pink cat



MASTER 24

MY SWEET CAT

29216 - 29217

- COPRIVOLANTE
- STEERING WHEEL COVER
- COUVRE-VOLANT
- Lenkradbezug
- FUNDA VOLANTE

29216		gattino bianco	white cat
29217		gattino rosa	pink cat

ø 38 cm



MASTER 12

MY SWEET KITTY

29022 - 29024

- COMPLETO FODERE AUTO 100% POLIESTERE
- SET SEAT CAR COVERS 100% POLYESTER
- JEU DE HOUSSES 100% POLYESTER
- Komplet Set Autositzbezüge 100% Polyester
- JUEGO FUNDA ASIENTO 100% POLIESTER

MASTER 6

29022		cuore rosa	pink heart
29024		cuore verde	green heart



SET COMPLETO:
 2 COPRISEDILI ANTERIORI
 5 APPOGGIATESTA
 2 POSTERIORI SEPARATI
 CON 3 ZIP
COMPLETE SET:
 2 FRONT SEATS +5 HEAD RESTS
 2 SEPARATE BACKS WITH 3 ZIP



PACKAGING
PVC BAG



5 cuffiette
headrest covers

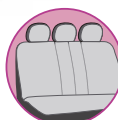

Zip System
1/2 1/3 2/3



AIR-BAG
system



UNIVERSALE
Universal



COLOUR
system

MY SWEET KITTY

29121

- SET 4 PZ. TAPPETI MOQUETTE
- 4 PCS TEXTILE CAR MATS
- JEU DE TAPIS MOQUETTE
- 4 Stk Automatten
- 4 PZAS ALFOMBRAS MOQUETA

29121		cuore rosa	pink heart
-------	--	------------	------------

MASTER 6

FRONT 45x65cm
REAR 44x33cm



MY BLACK DOUBLE FANTASY

29055 - 29056

- COPRISEDILE IN TESSUTO
- SEAT CUSHION
- HOUSSE DE SIÈGE 100% POLYESTER
- Sitzbezüge 100% Polyester
- CUBREASIENTO EN TEJIDO 100% POLIESTER

MASTER 12

29055		bianco/rosa	white/pink
29056		nero/rosa	black/pink



BORDATURA ELASTICA RINFORZATA IMBOTTITURA
REINFORCED ELASTIC CAGE QUILTING



PACKAGING
PVC BAG

MY CAT

17165

- SUPPORTO CERVICALE
- NECK SUPPORT
- SUPPORT CERVICAL
- Halsstütze
- APOYO CERVICAL

17165		fiocco azzurro	blue ribbon
-------	--	----------------	-------------



MASTER 20



SET TAPPETI IN GOMMA ANTISCIVOLO + LAMINATO IN PVC

29108

- SET 4 TAPPETI IN GOMMA CON SOTTOFONDO SPECIALE ANTISCIVOLO + LAMINATO IN PVC
- SET 4 PCS. UNIVERSAL PVC RUBBER CAR MATS WITH SPECIAL NONSLIP RUBBER ON THE BACK + PVC LAMINATED
- JEU DE 4 PIÈCES TAPIS EN PVC AVEC FOND SPECIAL ANTIGLISSEMENT DESSOUS
- 4 STK. Universele Automatten
- JUEGO DE 4 PIEZAS ALFOMBRAS DE PVC CON BASE ESPECIAL ANTIDESLIZANTE

29108		laminato rosa	pink
-------	--	---------------	------



MASTER 6

MY PUPPY

**2 ANIMALETTI
 PER TIPO DI FRAGRANZA
 12 PEZZI ASSORTITI**

29501

- PROFUMAZIONI NATURALI PER AUTO O PER QUALSIASI AMBIENTE
- NATURAL PERFUMES FOR CAR OR FOR ANY OTHER ENVIRONMENT
- SENTEURS NATURELLES POUR AUTO OU POUR N'IMPORTE QUEL ENVIRONNEMENT
- Natürliche Duftstoffe für Auto oder ein anderes, beliebiges Ambiente
- AROMAS NATURALES PARA AUTOMÓVIL O PARA CUALQUIER AMBIENTE

MASTER 48 INNER 12



CRYSTAL

29041 - 29042

- 2 PZ. SALVAPORTA
- 12 PCS. DOOR GUARDS
- 12 PCS. PROTÈGE PORTIÈRES
- 12 Stk. Türschutzleisten
- 12 PZ. SALVAPUERTAS



art. 29041



art. 29042

29041	cromo/cristallo trasparente
29042	nero/cristallo rosa



MASTER 100 INNER 10

HAWAII

art. dal 29405 al 29408

- COLLANA DECORATIVA DA APPENDERE ALL'INTERNO DELL'AUTO
- DECORATIVE NECKLACE TO BE HANGED INSIDE CAR
- COLLIER DECORATIF A SUSPENDRE A L'INTERIEUR DE LA VOITURE
- Deko-Kette zum anhängen im Auto
- AMBIENTADOR-COLLAR DECORATIVO PARA COLGAR EN EL INTERIOR DEL COCHE

art. 29405 VIOLA

art. 29406 GIALLO

art. 29407 ROSA

art. 29408 BLU



MASTER 60 INNER 30

MY HEART

29401

- PELUCHE DECORATIVO CON CORDA E VENTOSA
- DECORATIVE PLUSH WITH CORD AND SUCTION CUP
- PELUCHE DÉCORATIF AVEC CORDE ET VENTOUSE
- Dekorativ-Plüsch mit Schnur und Saugscheibe
- PELUCHE DECORATIVO CON CUERDA Y VENTOSA



CON CORDA
 E VENTOSA.
 WITH CORD AND
 SUCTION CUP.



MASTER 96 INNER 12

PINK MESH

29301

- PARASOLE IN ALLUMINIO MICROFORATO
- ALUMINIUM SUN SHADE WITH MESH MATERIAL
- PARASOL EN ALUMINIUM ET MATERIEL MICROFORE
- Sonnenschutz aus Aluminium und Gitternetz
- PARASOL EN ALUMINIO MICROPERFORADO

29301 rosa-pink 80 x 150 cm



MASTER 24



MY FLOWER

17167-17168

- SUPPORTO CERVICALE
- NECK SUPPORT
- SUPPORT CERVICAL
- Halsstütze
- APOYO CERVICALO



MASTER 20

17167		fiore rosa	pink flower
17168		fiore azzurro	light blue flower

fiore rosa
pink flower



fiore azzurro
light blue flower



MY DAISY

17169

- SUPPORTO CERVICALE
- NECK SUPPORT
- SUPPORT CERVICAL
- Halsstütze
- APOYO CERVICALO



MASTER 20



SET TAPPETI IN GOMMA ANTISCIVOLO LAMINATO IN PVC

17144-17145

- SET 4 TAPPETI IN GOMMA CON SOTTOFONDO SPECIALE ANTISCIVOLO LAMINATO IN PVC
- SET 4 PCS. UNIVERSAL PVC RUBBER CAR MATS WITH SPECIAL NONSLIP RUBBER ON THE BACK PVC LAMINATED
- JEU DE 4 PIÈCES TAPIS EN PVC AVEC FOND SPECIAL ANTIGLISSEMENT DESSOUS
- 4 STK. Universele Automatten
- JUEGO DE 4 PIEZAS ALFOMBRAS DE PVC CON BASE ESPECIAL ANTIDESLIZANTE



MASTER 6

17144		laminato blu	blue
17145		laminato nero	black



F 104

17184-17185-17187

- COPRIVOLANTE
- STEERING WHEEL COVER
- COUVRE-VOLANT POUR AUTO
- Lenkradbezug für Auto
- FUNDA VOLANTE PARA AUTO



Art. 17184



Ø 35-37 cm

Art. 17185



Ø 37-39 cm

Art. 17187



Ø 39-41 cm



CON INSERTI CROMATI
CHROMED INSERTS

MASTER 12

17184	CHROMED	Ø 35/37 cm
17185	CHROMED	Ø 37/39 cm
17187	CHROMED	Ø 39/41 cm

MESH

13604-13605-13606

- COPRIVOLANTE
- STEERING WHEEL COVER
- COUVRE-VOLANT POUR AUTO
- Lenkradbezug für Auto
- FUNDA VOLANTE PARA AUTO



Art. 13604-5-6



Ø 37-39 cm

POLIESTERE NIDO D'APE
MESH MATERIAL

MASTER 24

13604		nero-rosso	black-red
13605		nero-blu	black-blue
13606		nero-grigio	black-grey



SPEED POWER

17406-17407

- POMELLO CAMBIO
- GEAR KNOB
- POMMEAU DE LEVIER DE VITESSE
- Universal Knauf
- POMO PALANCA DE CAMBIO

MASTER 48 INNER 12

17406		nero-rosso	black-red
17407		nero-argento	black-silver



SIRIO

17431-17432-17433-17434

- POMELLO CAMBIO
- GEAR KNOB
- POMMEAU DE LEVIER DE VITESSE
- Universal Knauf
- POMO PALANCA DE CAMBIO

MASTER 48 INNER 12

17431		nero-rosso	black-red
17432		nero-blu	black-blue
17433		nero-grigio	black-grey
17434		nero	black

ECOPELLE



VENERE

17430

- POMELLO CAMBIO
- GEAR KNOB
- POMMEAU DE LEVIER DE VITESSE
- Universal Knauf
- POMO PALANCA DE CAMBIO

dotato anche di speciale innesto per FIAT PUNTO



MASTER 48 INNER 12

APACHE

13402

- POMELLO CAMBIO
- GEAR KNOB
- POMMEAU DE LEVIER DE VITESSE
- Universal Knauf
- POMO PALANCA DE CAMBIO

ALLUMINIO + PELLE
ALUMINIUM + LEATHER

MASTER 48 INNER 12

13402		giallo-nero	yellow-black
-------	--	-------------	--------------



SPEED STOP

13525-13526

- COPRIFRENO A MANO
- HAND BRAKE COVER
- HOUSSE DU FREIN A MAIN
- Modische Abdeckung für Handbremse
- CUBREFRENO DE MANO

PVC ALLUMINIO
 ALUMINIUM PVC



MASTER 48 INNER 12

13525	grigio-grigio	grey-grey
13526	nero-grigio	black-grey

LIGHT

13682

- ACCENDISIGARI CON LUCI LED
- CIGARETTE LIGHTER WITH LED LIGHTS
- ALLUME-CIGARES AVEC LUMIÈRE LED
- Zigarettenanzünder mit Leuchtdiode
- ENCENDEDOR CON LUZES LED



12V

MASTER 50 INNER 10

13682	blu	blue
-------	-----	------

R.CHROME

15506

- SALVAPORTA AD INCASTRO
- SLOT DOOR GUARDS
- PROTÈGE PORTIÈRES À ENCASTREMENT
- Aufsteckbare Türschutzleisten
- SALVAPUERTAS CON ENCAJE



LARGHEZZA/WIDTH 1 cm

2 PCS. x 87 cm - 2 PCS. x 67 cm

KIT 4 PEZZI ANTERIORE - POSTERIORE

MASTER 100 INNER 10

R.SHAPE

15521-15522-15524

- SALVAPORTA ADESIVI
- DOOR GUARDS WITH ADHESIVE
- PROTÈGE PORTIÈRES AVEC ADHÉSIF
- Türschutzleisten mit Kleber
- SALVAPUERTAS CON ADHESIVO

15521	cromato	chromed	4pcs
15522	carbonio	carbon	4pcs
15524	grigio	grey	4pcs



LARGHEZZA/WIDTH 1,3 cm

2 PCS. x 87 cm - 2 PCS. x 67 cm

KIT 4 PEZZI ANTERIORE - POSTERIORE

MASTER 100 INNER 10



POWER X

15033

- TERMINALE MARMITTA
- EXHAUST MUFFLER
- RACCORD EMBOUT DE ÉCHAPPEMENT
- Auspuffblende
- EMBELLECEDOR COLAS DE ESCAPE



INOX

MASTER 10

FORO DI ENTRATA
 130mm x 85mm

FURIUS

15009

- TERMINALE MARMITTA
- EXHAUST MUFFLER
- RACCORD EMBOUT DE ÉCHAPPEMENT
- Auspuffblende
- EMBELLECEDOR COLAS DE ESCAPE



ALUMINIUM

MASTER 18 INNER 6

FORO DI ENTRATA
 Ø 60mm

PIPE

15008

- TERMINALE MARMITTA
- EXHAUST MUFFLER
- RACCORD EMBOUT DE ÉCHAPPEMENT
- Auspuffblende
- EMBELLECEDOR COLAS DE ESCAPE



MASTER 18 INNER 6



ALUMINIUM

FORO DI ENTRATA
 Ø 60mm

R.2TT

15012

- TERMINALE MARMITTA
- EXHAUST MUFFLER
- RACCORD EMBOUT DE ÉCHAPPEMENT
- Auspuffblende
- EMBELLECEDOR COLAS DE ESCAPE



Ø 75 MM, LENGHT 125 MM



INOX

MASTER 32 INNER 8

FORO DI ENTRATA
 Ø 60mm

SOUNDLESS-2-3

15007

- SONORIZZATORE MARMITTA
- ACOUSTIC SILENCER
- DISPOSITIF DE SONORISATION POT D'ÉCHAPPEMENT
- Auspuffbeschaller
- SONORIZADOR TUBO DE ESCAPE



MASTER 48 INNER 12

15007

lunghezza 37-48 mm

15007 - LENGHT 37-48 MM

RADAR

LUNGHEZZA 9 CM - LENGHT 9 CM

15065-15068

- ANTENNA IN ALLUMINIO
- ALUMINIUM ANTENNA
- ANTENNE ALUMINIUM
- Aluminium Antenne
- ANTENA EN ALUMINIO



ALLUMINIO CON
 VERNICIATURA
 ANTICORROSIONE
 INOX
 TREATMENT



9 cm
 aluminium
 style



MASTER 60 INNER 12

15065	nero	black
15068	cromato	chromed

WAVE

LUNGHEZZA 16 CM - LENGHT 16 CM

15069-15072

- ANTENNA IN ALLUMINIO
- ALUMINIUM ANTENNA
- ANTENNE ALUMINIUM
- Aluminium Antenne
- ANTENA EN ALUMINIO



MASTER 60 INNER 12

15069	nero	black
15072	cromato	chromed



16 cm
 aluminium
 style



TRIMMING

15548-15549

- PROFILO CROMATO CON NASTRO BIADESIVO
- CHROMED PROFILE WITH DOUBLE FACE TAPE
- PROFIL CHROMÉ AVEC RUBAN BI-ADHÉSIF
- Verchromtes Profil mit Klebstreifen
- PERFIL CROMADO CON CINTA ADHESIVA DOBLE

3M
 STICKER



MASTER 50 INNER 10

15548	4 m	7mm x 4m
15549	8 m	7mm x 8m

AIR LINE

LUNGHEZZA 15,5 CM - LENGHT 15,5 CM

15073

- ANTENNA DECORATIVA
- DECORATIVE AERIAL
- ANTENNE DÉCOTARIVE
- Dekorationsantenne
- ANTENA DECORATIVA



MASTER 100 INNER 25

15073	nero	black
-------	------	-------

X-DEAD

17500

- BANDA ANTISTATICA
- SHOCK CONDUCTOR
- BANDE ANTISTATIQUE
- Erdungsband
- BANDA ANTIESTÁTICA



MASTER 40 INNER 10



AIR CUP

**15099A-15100A-15101A
15102A-15102BLACK A**

- KIT 4 PZ. COPRIVALVOLE IN ALLUMINIO
- 4 PCS. TYRE VALVE CUPS
- KIT 4 PCS. BOUCHONS DE VALVES ALUMINIUM
- 4 Stück alu Vintile Kappen
- JUEGO 4 PZAS. TAPONES VALVULAS NEUMATICO



15099A	dark gray
15100A	dark blue
15101A	red
15102A	chrome silver
15102BLACK A	black

MASTER 96 - INNER 24

AIR CUP

**15099B-15100B-15101B
15102B-15102BLACK B**

- KIT 4 PZ. COPRIVALVOLE IN ALLUMINIO
- 4 PCS. TYRE VALVE CUPS
- KIT 4 PCS. BOUCHONS DE VALVES ALUMINIUM
- 4 Stück alu Vintile Kappen
- JUEGO 4 PZAS. TAPONES VALVULAS NEUMATICO



15099B	dark gray
15100B	dark blue
15101B	red
15102B	chrome silver
15102BLACK B	black

MASTER 96 - INNER 24

TIRE CUP

**27515A-27516A-27517A
27518A-27519A**

- KIT 4 PZ. COPRIVALVOLE IN ALLUMINIO
- 4 PCS. TYRE VALVE CUPS
- KIT 4 PCS. BOUCHONS DE VALVES ALUMINIUM
- 4 Stück alu Vintile Kappen
- JUEGO 4 PZAS. TAPONES VALVULAS NEUMATICO



27515A	chrome silver
27516A	dark blue
27517A	red
27518A	black
27519A	dark grey

MASTER 96 - INNER 24

TIRE CUP

**27515B-27516B-27517B
27518B-27519B**

- KIT 4 PZ. COPRIVALVOLE IN ALLUMINIO
- 4 PCS. TYRE VALVE CUPS
- KIT 4 PCS. BOUCHONS DE VALVES ALUMINIUM
- 4 Stück alu Vintile Kappen
- JUEGO 4 PZAS. TAPONES VALVULAS NEUMATICO



27515B	chrome silver
27516B	dark blue
27517B	red
27518B	black
27519B	dark grey

MASTER 96 - INNER 24

TORPEDO

17825

10x31



Approved

- 2 LAMPADE SILURO LEDS
- 2 FESTOON BULBS LEDS
- COUPLE LAMPES TORPILLE LEDS
- 2 Torpedolampen mit Leuchtdioden
- 2 LÁMPARAS PLAFONIER DE LEDS

PER PLAFONIERA E LUCE TARGA



3 LED BIANCHI - WHITE LED

MASTER 500 INNER 50

SHINY

13836-13837-13838

- COPPIA LUCI NEON
- PAIR OF NEON LAMPS
- PAIRE DE LAMPES A NÉON
- Paar Neonleuchten
- PAREJA LUCES NEÓN

2 PZ. 23CM

MASTER 20 INNER 10



FUNZIONA CON PRESA ACCENDISIGARI E SI FISSA COL BIADESIVO IN DOTAZIONE. CON CENTRALINA CONTROLLO LUCI.

PLUGS INTO THE CIGARETTE LIGHTER SOCKET AND IS FIXED WITH BI-ADHESIVE TAPE. WITH LIGHT CONTROL BOX.



13836		rosso	red
13837		viola	violet
13838		verde	green

MINI-LIGHT

13808-13809

- LUCE NEON
- NEON LIGHT
- NÉON RÉGLABLE
- Neon Schwarzlicht
- LUZ DE NEON

1 PZ. 7,5CM

MASTER 40 INNER 20

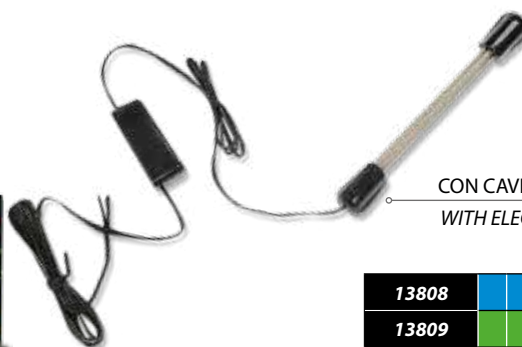

CON CAVI ELETTRICI
WITH ELECTRIC CABLES



13808		blu	blue
13809		verde	green

ALL-NIGHT

13800

- COPPIA LUCI FISSE ON PIEDISTALLO
- PAIR OF FIXED LIGHTS WITH BLEUES SUR SOCLE
- PAREJA LUCES FIJAS CON PEDESTAL
- Paar Leuchten mit Feststehendem
- LICHT UND SOCKEL

MASTER 36 INNER 12



FUNZIONA CON PRESA ACCENDISIGARI E SI FISSA COL BIADESIVO IN DOTAZIONE.

PLUGS INTO THE CIGARETTE LIGHTER SOCKET AND IS FIXED WITH BI-ADHESIVE TAPE.



13800		blu	blue
-------	--	-----	------

LASER

13979

- PORTACHIAVI LUMINOSO
- LIGHTING KEY HOLDER
- PORTE-CLEFS LUMINEUX
- Leuchtende Schlüsselkette
- LLAVERO LUMINOSO

MASTER 120 INNER 20



13979		blu	blue
-------	--	-----	------

MAGIC

13936

- COPPIA LUCI LED
- PAIR OF LED LIGHT
- COUPLE LUMIERE LED
- Led-Lichterpaar
- PAREJA LUCES LED



1 LED
T10



MASTER 120 INNER 12

13936		bianco	white
-------	--	--------	-------

CHARM

13938-13939

- COPPIA LUCI 4 LED
- PAIR OF LIGHTS WITH 4 LEDS
- COUPLE LUMIÈRES 4 LEDS
- 4 Led-Lichterpaar
- PAREJA LUCES 4 LEDS



4 LED
T10



MASTER 120 INNER 12

13938		blu	blue
13939		bianco	white

ENIGMA

17852



- COPPIA LAMPADE FANALI ANTERIORI
- PAIR OF BULBS FRONT LIGHTS
- COUPLE LAMPES FEUX ANTÉRIEURS
- Lampepaar Vorderlicht
- PAREJA LAMPARILLAS FAROS ANTERIORES

12V 5W
T10

LA LUCE RIMANE ARANCIONE,
EFFETTO TRASPARENTE LUCE SPENTA

LIGHT KEEP AMBER COLOR ONLY
TRANSPARENT EFFECT LIGHT OFF



MASTER 400 INNER 10

LUCE ACCESA ARANCIONE

MATCH

13841

- COPRIFRENO A MANO LUMINOSO
- LED HANDBRAKE COVER
- COUVERTURE DE FREIN À MAIN DE LED
- Led Aabdeckung für Handbremsstange
- LA CAPA DECORATIVA DE LA BARRA DE FRENO MANULA DE LED



CON CAVI ELETTRICI
WITH ELECTRIC CABLES

MASTER 100 INNER 20

13841		blu	blue
-------	--	-----	------

TRIM

13868

- TERMOMETRO LUMINOSO
- LUMINOUS THERMOMETER
- THERMOMÈTRE LUMINEUX
- Leucht-Thermometer
- TERMÓMETRO LUMINOSO



CON BASE ADESIVA.
FUNZIONA CON PILA INCLUSA.
WITH ADHESIVE BASE.
WORKS WITH BATTERY.



ADESIVO 3M - 3M TAPE

MASTER 100 INNER 20

13868		blu	blue
-------	--	-----	------

R.BUMPER

15510

- 2 PZ. SALVAURTI ADESIVI
- 2 PCS. ADHESIVE BUMPER
- 2 PCS. PROTÈGE PARE-CHOCS ADHÉSIF
- 2 Stück Stosstangenschützer
- 2 PZAS. PROTECTOR PARACHOQUES



MASTER 24 INNER 6

15510	nero	black
-------	------	-------

NISSAN HKS S15

17930

- MODELLINO AUTO
- MODEL CAR
- MAQUETTE AUTO
- Modellauto
- MODELO AUTO



1:64 SCALE

MASTER 96 INNER 24

NISSAN RX-7 APEX

17931

- MODELLINO AUTO
- MODEL CAR
- MAQUETTE AUTO
- Modellauto
- MODELO AUTO



1:64 SCALE

MASTER 96 INNER 24





CAMION

TRUCK ACCESSORIES

SUPPORTO VENDITA CAMION





CAMION

TRUCK ACCESSORIES

COPRIVOLANTE - CARTA CARBURANTE	pag 348
IDROPAZZOLE - MANICI	pag 349
ACCESSORI	pag 350
CORDA TRAINO - KIT CHIAVI	pag 351
ASPIRAPOLVERE - CAVI BATTERIA	pag 352
CINGHIA DI FISSAGGIO - KIT VALIGETTA PRONTO SOCCORSO	pag 353
CATENE	pag 354
ESTINTORI - ACCENDISIGARI	pag 355



STYLISH

16767-16768

- COPRIVOLANTE
- STEERING WHEEL COVER
- COUVRE-VOLANT POUR AUTO
- Lenkradbezug für Auto
- FUNDA VOLANTE PARA AUTO



CON CUCITURA DI RINFORZO

Si adatta perfettamente all'impugnatura anatomica del volante.

Preso confortevole sia in estate che in inverno.

MASTER 12

16767	per furgoni	for trucks and vans	Ø 41-45 cm
16768	per furgoni	for trucks and vans	Ø 39-41 cm

Art. 16768



Ø 39-41 cm

Art. 16767



Ø 41-45 cm



CARTA CARBURANTE

36030

- CARTA CARBURANTE 12 MESI
- 12 MONTHS FUEL SHEETS
- CARTE CARBURANT 12 MOIS
- Tankbelege für 12 monate
- TARJETA CARBURANTE 12 MESES



CARTA CARBURANTE 12 MESI



MASTER 120 INNER 60

HYDROBRUSH

32236

- IDROSPAZZOLA PER LAVAGGIO AUTO, CAMION, CAMPER, CON SETOLE SINTETICHE. CONSENTE DI EFFETTUARE UNA PULIZIA PROFONDA RIMUOVENDO LO SPORCO PIÙ OSTINATO E RISPETTANDO, CONTEMPORANEAMENTE LA VERNICIATURA DEL MEZZO.
- WATER BRUSH FOR WASHING CARS, TRUCKS, CAMPERS WITH SYNTHETIC BRISTLES. ALLOWS A THOROUGH CLEANING BY REMOVING STUBBORN DIRT WHILE NOT DAMAGING THE VARNISH.
- BROSE POUR LAVAGE AVEC DES POILS SYNTHÉTIQUES
- Hydrobürste für die Autowäsche mit synthetischen Borsten
- HIDROCEPILLO PARA LAVADO CON CERDAS SINTÉTICAS

MASTER 30



Art. 32236



AUTO

CAMPER

CAMION



HYDROHANDLE

32237

- MANICO PER IDROSPAZZOLA CON IMPUGNATURA ERGONOMICA E PULSANTE DI FLUSSO
- WATER BRUSH STICK WITH ERGONOMICAL HANDLE AND PUSH BOTTON
- MANCHE POUR BROSE AVEC PRÉHENSION ERGONOMIQUE
- Spritzlanze für Hydrobürste mit ergonomischem Handgriff
- MANGO PARA HIDROCEPILLO CON EMPUÑADURAS ERGONÓMICAS

MASTER 30



Art. 32237

IMPUGNATURA ERGONOMICA

FACILE UTILIZZO

ERGONOMICAL HANDLE



TELESCOPICO-TELESCOPIC
140÷280cm

Art. ESPO
32238



IDROCAR PVC

32210

- IDROSPAZZOLA CON SETOLA SINTETICA
- SYNTHETIC HYDRO BRUSH
- BROSSE DE LAVAGE AVEC SOIE SYNTHETIQUE
- Autowaschbürste aus synthetischen Borsten
- CEPILLO DE LAVADO SINTETICO PVC



MASTER 12

IDROCAR CRINE

32212

- IDROSPAZZOLA CON SETOLA IN CRINE
- HORSEHAIR HYDRO BRUSH
- BROSSE DE LAVAGE AVEC SOIE EN CRIN
- Autowaschbürste aus Rosshaarborsten
- CEPILLO DE LAVADO CERDAS



MASTER 12

MANICI IDROCAR

32230 - 32234

- MANICO PER IDROSPAZZOLA CON IMPUGNATURA ERGONOMICA
- WATER BRUSH STICK WITH ERGONOMICAL HANDL
- MANCHE POUR BROSSE AVEC PRÉHENSION ERGONOMIQUE
- Spritzlanze für Hydrobürste mit ergonomischem Handgriff
- MANGO PARA HIDROCEPILLO CON EMPUÑADURAS ERGONÓMICAS



MASTER 12

32230	180 cm	
32234	100>200 cm	TELESCOPICO-TELESCOPIC

TRUCKER TABLE

16461

- TAVOLO PORTAOGGETTI REGOLABILE 43 X 35 CM
- SMALL TABLE FOR OBJECTS 43 X 35 CM
- TABLETTE PORTE OBJETS 43 X 35 CM
- Objektträgertisch 43 x 35 cm
- MESITA PORTAOBJETOS 43 X 35 CM

IDEALE PER FURGONI CAMPER - CAMION



REGOLABILE

ADJUSTABLE

MASTER 10

16461 43 x 35 cm

KIENZLE DISCHI 125

36001

- CONFEZIONE DA 100 DISCHI TACHIGRAFO KOMBI
- TACHOGRAPH DISKS IN 100 PCS. PACKAGING
- BOITE 100 PCS. DISQUES TACHYGRAPHE KOMBI
- Kombi-Packung 100 stk. Für Fahrtschreiberscheiben
- PAQUETE 100 PZ. DISCO TACOGRACO KOMBI



MASTER 60

TRAINO CAR

28009

- CORDA TRAINO ELASTICA
- ELASTICIZED TOW ROPE
- CORDE ÉLASTIQUE POUR REMORQUE
- Elastisches Abschleppseil
- CUERDA REMOLQUE

28009	400 cm	5000 Kg	ø 8 mm
--------------	--------	---------	--------

MASTER 20



KIT CHIAVI TOP2

24013 - 30 PEZZI

- KIT CHIAVI 30 PEZZI
- SPANNER KIT 30 PIECE
- KIT DE CLEFS 30 PIECES
- Kit Schlüssel 30 Stück
- KIT LLAVES 30 PIEZAS

MASTER 6

24013	30 PEZZI
--------------	----------



**ASSORTIMENTO
 DI UTENSILI PER**

**AUTO, CASA,
 FAI DA DE**

ASSORTMENT OF TOOLS
 FOR USE IN
 CAR, AT HOME, DIY

MATERIALE GARANTITO
**CHROME
 VANADIUM**
 GUARANTEED MATERIAL
 GWARANTOWANY SKŁAD MATERIAŁU



MAXI CLEANER

30066

- ASPIRAPOLVERE 12V 80 W
- 12V 80 W – VACUUM CLEANER
- 12V 80 W – ASPIRATEUR
- 12V 80 W – Staubsauger
- 12V 80 W – ASPIRADORA



Mantiene l'interno della tua automobile pulito ed elimina polvere e fango.

Keep your car interior always tidy from dirty dust and mud.



- ✓ Pratica conservazione del cavo dopo l'uso
- ✓ Convenience to keep the cord after used



MASTER 12

CAVI BATTERIA

28026

- CAVI BATTERIA 500A PROFESSIONALI Ø 25 MM-300 CM
- PROFESSIONAL 500A BATTERY CABLES Ø 25 MM-300 CM
- CABLE BATTERIE 500A PROFESSIONEL Ø 25 MM-300 CM
- Profi-Batteriekabel 500A Ø 25 mm-300cm
- CABLE BATERIA 500A PROFESIONAL Ø 25 MM-300 CM

**IN CONTENITORE/
SACCA**

**CON ZIP
RICHIUDIBILE**

**500
AMPERE**

12-24V



**IDEALE
PER FURGONI
CAMPER - CAMION**

CON PINZE
DI SICUREZZA

CINGHIE MASTER

18203

- CINGHIA DI FISSAGGIO CON CRICCHETTO
- STRAP WITH RATCHET
- SANGLE DE FIXAGE AVEC CLIQUET
- Riemen mit spann-schnalle
- CINCHA DE FIJACIÓN CON GATO

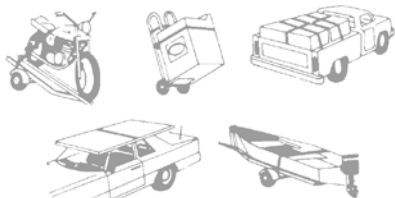

art. 18203
3000 Kg - 5 mt
 film pack

MASTER 20

18203	500 cm	3000 Kg	MASTER 15
--------------	--------	---------	-----------

VALIGETTA PRONTO SOCCORSO

28034

- KIT VALIGETTA PRONTO SOCCORSO PER AUTO E FURGONI
- FIRST AID KIT FOR CARS AND TRUCKS
- KIT VALISE DE PREMIERS SECOURS POUR LES VOITURES ET LES CAMIONNETTES
- KIT Erste-Hilfe-Koffer zugelassen für Autos und Lieferwagen
- KIT MALETÍN DE PRIMEROS AUXILIOS PARA COCHE Y FURGONES



MASTER 24

KIT PRONTO SOCCORSO CON VELCRO

28039

- KIT PRONTO SOCCORSO CON VELCRO
- FIRST AID KIT FOR CARS AND TRUCKS WITH VELCRO
- KIT VALISE DE PREMIERS SECOURS
- KIT Erste-Hilfe-Koffer zugelassen
- KIT MALETÍN DE PRIMEROS AUXILIOS



MASTER 36 INNER 12



- CONTIENE:**
- 1X 160X210CM - COPERTA DI SOCCORSO - FIRST AID BLANKET
 - 8X 10X6CM - CEROTTI ADESIVI - ADHESIVE DRESSING
 - 3X 8X10CM - 1X 10X12CM - PACCHETTO MEDICAZIONE STERILE FIRST AID DRESSING STERILE
 - 2X 136X96X96CM - TRIANGOLO BENDAGGIO - TRIANGULAR BANDAGE GRANDE-LARGE
 - 2 PAIA GUANTI MONOUSO - 2 PAIRS DISPOSABLE GLOVES
 - 1X 5MTX2,5CM - CEROTTO ADESIVO - ADHESIVE TAPE
 - 3X 10X10CM - COMPRESSE STERILI DI TNT - WOUND COMPRESS STERILE
 - 1X 60X80CM - 2X 40X60CM - TELO STERILE MEDICAZIONE USTIONI BURN DRESSING STERILE
 - 3X 8X4CM - 2X 6X4CM - BENDA DI GARZA ELASTICA - ELASTI BANDAGE

**OMOLOGAZIONE EUROPEA
 DIN 13164
 EUROPEAN HOMOLOGATION
 DIN 13164**

TRUCK-TOP

da **68029 - 68030 - 68040**

- CATENE NEVE PER VEICOLI INDUSTRIALI. BATTISTRADA CON DISEGNO A ROMBO IN ACCIAIO SPECIALE ZINCATO
- SNOW CHAINS FOR HEAVY DUTY TRUCKS "DIAMOND" SHAPE CHAIN STAINLESS STEEL ANTIWEAR TREATMENT, ZINC GALVANIZING
- CHÂÎNES EIGE POUR VÉHICULES INDUSTRIELS. BANDE DE ROULEMENT AVEC DESSIN À RHOMBE EN ACIER SPÉCIAL ZINGUÉ
- Schneeketten fuer Nutzfahrzeug. Profil mit Rhombus-Zeichnen, aus spezial verzinkter Stahl
- CADENAS DE NIEVE PARA VEHÍCULOS INDUSTRIALES. MÓDELO TIPO ROMBO, FABRICADA EN ACERO GALVANIZADO



MASTER 1

UNI 11313:2010



EINSATZBEREICH
PKW
V 5117



Prodotto conforme alla norma di unificazione europea del ministero delle infrastrutture e dei trasporti. Queste catene sono omologate e certificate secondo le norme: **UNI 11313:2010 E ÖNORM**

Come certificato dal gs-tüv istituto leader europeo per le certificazioni dei prodotti nel settore dei trasporti.

The product conforms to the european unification regulations by the ministry of infrastructures and transport. These chains are authorised and certified in conformity to the following regulations: **UNI 11313:2010 E ÖNORM**

As certified by gs-tüv, the leading european institute for certification of products in the transport sector.

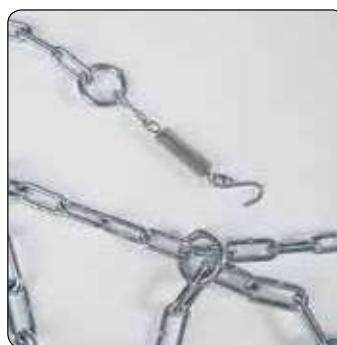

1



2

CODICE		15	16	17.5	19.5	20	22	22.5	24	24.5
68029	260		750-16	8,5-17,5	7-19,5					
			235/85-16	225/75-17,5						
68030	310					1000-20		11-22,5		
						12,4-20		D22,5 Pilote		
						12/80-20		275/80-22,5		
						D20 Pilote		305/70-22,5		
								315/70-22,5		
68040	520					14,5-20		15-22,5	320/70-24	
						14,9-20		385/65-22,5		
						14/18-20				
						F20 Pilote				
						365/80-20				
						375/75-20				

ESTINTORE SPRAY

31520 - 35196

- ESTINTORE SPRAY ADATTO PER SPEGNERE PICCOLI FUOCHI
- SPRAY EXTINGUISHER
- EXTINGUEUR
- Feuerlöscher
- EXTINTOR



Art. 31520

450ml



Art. 35196

1000ml

Viene utilizzato per domare gli incendi sulle auto, sulle barche, negli uffici, nelle case, ecc. Non è tossico, non è dannoso per l'ambiente e neanche macchiante. Può essere utilizzato per estinguere l'attrezzatura elettrica con voltaggio fino a 1000V dalla distanza di 1 metro.

Ideal for extinguishing cars, boats, offices, houses, etc. Nontoxic, environment-friendly, stain-resistant. Can be used to extinguish fires, including electric equipment up to 1000V in distance 1 m.



FIRST AID FIRE

28086

- ESTINTORE OMOLOGATO RINA A/B/C DA 1 KG CON MANOMETRO
- FIRE EXTINGUISHER A/B/C RINA HOMOLOGATION. WEIGHT: 1 KG WITH MANOMETER
- EXTINGUEUR HOMOLOGUÉ RINA A/B/C 1 KG
- Zugelassener Feuerlöscher a/b/c-rina 1 kg
- EXTINTOR HOMOLOGADO A/B/C-RINA DE 1KG

1kg

CON MANOMETRO - WITH MANOMETER

MASTER 6



FOUR-SOCKET

30071 - 12V/24V

- PRESE ACCENDISIGARI CON CAVO 12V/24V
- CIGARETTE LIGHTER PLUG WITH CABLE 12V/24V
- PRISE ALLUME-CIGARE AVEC CÂBLE 12V/24V
- Steckerbuchse für Zigarettanzünder mit Kabel 12V/24V
- TOMA ENCENDEDOR CON CABLE 12V/24V

MASTER 96 INNER 24

PRESE ILLUMINATE PER FACILE LOCALIZZAZIONE AL BUIO
CAVO DIRITTO PER MAGGIORE PRATICITÀ
FISSAGGIO ANCHE CON VITI

ILLUMINATED SOCKETS FOR NIGHT TIME LOCATION
STRAIGHT CABLE FOR TIDY USAGE
SCREW MOUNTING



THREE-SOCKET

30072 - 12V/24V

- PRESE ACCENDISIGARI CON CAVO 12V/24V
- CIGARETTE LIGHTER PLUG WITH CABLE 12V/24V
- PRISE ALLUME-CIGARE AVEC CÂBLE 12V/24V
- Steckerbuchse für Zigarettanzünder mit Kabel 12V/24V
- TOMA ENCENDEDOR CON CABLE 12V/24V

MASTER 96 INNER 24

PRESE ILLUMINATE PER FACILE LOCALIZZAZIONE AL BUIO
CAVO DIRITTO PER MAGGIORE PRATICITÀ
FISSAGGIO ANCHE CON VITI

ILLUMINATED SOCKETS FOR NIGHT TIME LOCATION
STRAIGHT CABLE FOR TIDY USAGE
SCREW MOUNTING





MOTO E BICI

MOTORBIKE AND BIKE ACCESSORIES

SUPPORTO VENDITA MOTO E BICI





MOTO E BICI

MOTORBIKE AND BIKE ACCESSORIES

MOTO ACCESSORIES pag 358

BIKE ACCESSORIES pag 390



SKINEMOTION

art. 64650-64651-64652-64653

- Calotta in resina termoplastica rifinita in vera pelle
- Interno in tessuto anallergico
- Visiera in policarbonato
- Fibbie micrometriche
- Inserti in pelle
- Verniciature antiriflesso (effetto gommato)
- *Shell in thermoplastic resin with real leather finishing*
- *Anallergic comfort padding*
- *Visor in polycarbonate*
- *Micrometrical retention system*
- *Leather finishing*
- *Rubber painting*



Calotta rifinita in vera pelle



SKINEMOTION



RIFINITURE ARTIGIANALI



S	BLACK RUBBER		
64650	■ black rubber	size S	80 16038 64650 1
64651	■ black rubber	size M	80 16038 64651 8
64652	■ black rubber	size L	80 16038 64652 5
64653	■ black rubber	size XL	80 16038 64653 2
XL	MASTER 6		



TERMINATOR

art. 62815

- Guanti in vera pelle con tessuto amara e kevlar e con protezioni carbonio
- Gloves in real leather with Amara and Kevlar fabrics and carbon protection

62815 ■ black size M 80 16038 62815 6



PINK

art. 63990XS PINK
63991M PINK
63991L PINK

- Guanti in vera pelle traspiranti
- Half-finger gloves

63990XS PINK ■ black pink size XS 80 16038 63990 9
63991M PINK ■ black pink size M 80 16038 63991 6
63991L PINK ■ black pink size L 80 16038 63991 6



Lady



VIOLET

art. 63991M VIOLET
63991L VIOLET

63991M VIOLET ■ black violet size M 80 16038 63991 6
63991L VIOLET ■ black violet size L 80 16038 63991 6

Lady



PREDATOR

art. 64001

64001 ■ black CROMATI 80 16038 64001 1

- Occhiali motociclista cromati ovali
- Motorcyclist glasses

ATOMIC

art. 64002

64002 ■ black 80 16038 64002 8

- Occhiali neri motociclista regolabili
- Motorcyclist black glasses



THUNDER

art. 64006

64006 ■ black 80 16038 64006 6

- Occhiali neri motociclista regolabili
- Motorcyclist black glasses



TIFFANY

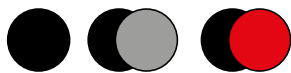

art. 62429

CORDURA BLACK/GREY/RED

- Giacca in cordura
- Cordura jackets

62429 ■ ■ ■ black/grey/red size L 80 16038 62429 5



DIKINSON

art. 62041-62042-62043-62047-62048

- Giacca in cordura
- Cordura jackets

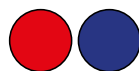

CORDURA RED

62041 ■ red size L 80 16038 62041 9

62042 ■ red size XL 80 16038 62042 6

62043 ■ red size XXL 80 16038 62043 3

CORDURA BLUE

62047 ■ blue size XL 80 16038 62047 1

62048 ■ blue size XXL 80 16038 62048 8



ROAD RUNNER



art. 62401-62402

- Giacca in vera pelle
- Leather jackets

62401 ■ black size L 80 16038 62401 1

62402 ■ black size XL 80 16038 62402 8



art. 62406-62407

- Giacca in vera pelle
- Leather jackets

62406 ■ black/white size L 80 16038 62406 6

62407 ■ black/white size XL 80 16038 62407 3

BROOKS

art. 62420-62421-62422-62423

- Giacca in vera pelle e cordura
- Real leather and Cordura jacket



CORDURA BLACK AND LEATHER

62420	■	black	size M	80 16038 62420 2
62421	■	black	size L	80 16038 62421 9
62422	■	black	size XL	80 16038 62422 6
62423	■	black	size XXL	80 16038 62423 3



OXFORD

art. 72490-72491-72492-72493

- Giacca impermeabile con collo alto e finiture 3M
- Waterproof jacket with high neck and finishes 3M

WATERPROOF

72490	■	black size M	80 16038 72490 2
72491	■	black size L	80 16038 72491 9
72492	■	black size XL	80 16038 72492 6
72493	■	black size XXL	80 16038 72493 3



INDIANAPOLIS

art. 72007-72008-72009

- Giacca in cordura
- Cordura jackets



CORDURA

72007	■	■	■	black blue white size L	80 16038 72007 2
72008	■	■	■	black blue white size XL	80 16038 72008 9
72009	■	■	■	black blue white size XXL	80 16038 72009 6



LIBERTY

art. 62386-62387-62388-62389-62390-62391-62392-62394-62395-62396-62397

- Giacca in cordura
- Cordura jackets



CORDURA RED AND WHITE

62386	■	red	size XS	80 16038 62386 1
62387	■	red	size S	80 16038 62387 8
62388	■	red	size M	80 16038 62388 5
62389	■	red	size L	80 16038 62389 2

CORDURA PINK AND WHITE

62390	■	pink	size XS	80 16038 62390 8
62391	■	pink	size S	80 16038 62391 5
62392	■	pink	size M	80 16038 62392 2

CORDURA LIGHT BLUE AND WHITE

62394	■	light blue	size XS	80 16038 62394 6
62395	■	light blue	size S	80 16038 62395 3
62396	■	light blue	size M	80 16038 62396 0
62397	■	light blue	size L	80 16038 62397 7

ADMIRAL

art. 62650-62651-62652

- Tuta intera antipioggia/antivento
- Full rainproof suit



WATERPROOF

62650	■ black	size M	80 16038 62650 3
62651	■ black	size L	80 16038 62651 0
62652	■ black	size XL	80 16038 62652 7

SURE

art. 62654-62655

- Pantaloni impermeabili
- Waterproof trousers

WATERPROOF

62654	■ black	size M	80 16038 62654 1
62655	■ black	size L	80 16038 62655 8



TIGER X

art. 62604

62604 ■ black UNIV 80 16038 62604 6

- Coppia copriguanti/mani
- Glove/hand cover



EASY

art. 62600

62600 ■ black UNIV 80 16038 62600 8

- Coppia copriscarpe copristivali impermeabili
- Pair of waterproof shoe covers



NO-WET

art. 62601

62601 ■ black UNIV 80 16038 62601 5

- Salvascarpe/salvastivali universale in pelle
- Universal leather shoe protector



POLAR

art. 62683

62683 ■ black UNIV 80 16038 62683 1

- Salvacollo in taslan certificato
- Neck protector in attested Taslan



RELAX

art. 62685

62685 ■ black size L 80 16038 62685 5

- Salvacollo in taslan certificato con cerniera
- Neck protector in attested Taslan with zip



HEAVY

art. 62681-62676

62681	■ black	UNIV	80 16038 62681 7
62676	■ blue YAMAHA	UNIV	80 16038 62676 3

- Sottocasco integrale in wind stopper anallergico
- Under full-face helmet in wind stopper hypoallergenic

LIGHT

art. 62678-62679

62678	■ red DUCATI	UNIV	80 16038 62678 7
62679	■ blue YAMAHA	UNIV	80 16038 62679 4

- Sottocasco in seta 100% gorotex
- Under full-face helmet in gorotex silk

in gorotex

in pile

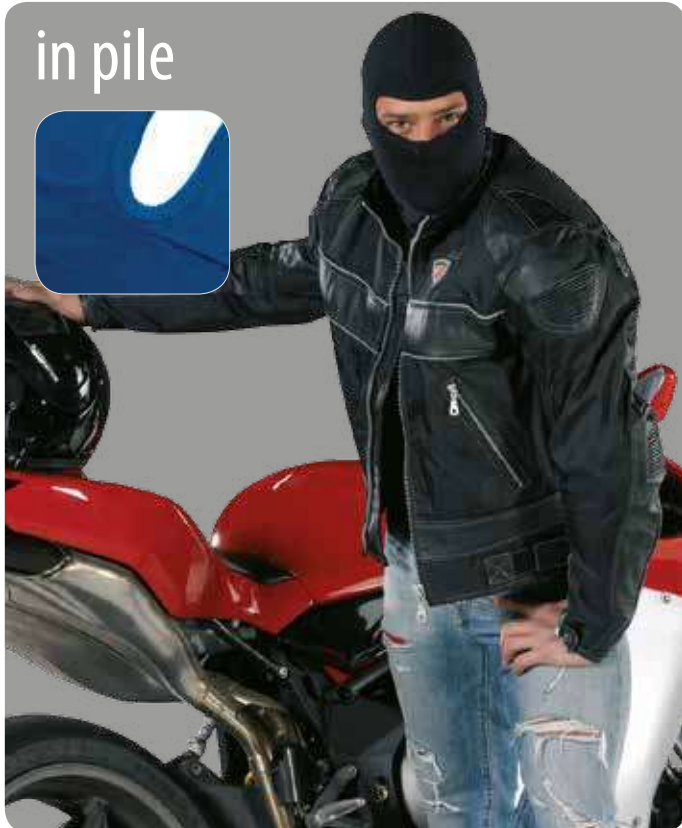

FOULAR

art. 62690-62691

62690	■ black/white	UNIV	80 16038 62690 9
62691	■ fantasy	UNIV	80 16038 62691 6

- Foular d in seta trattata
- Silk Scarf



art. 62690

art. 62691
FANTASY



STIVALI ROAD

art. 63997

Stivali da moto in vera pelle
con membrana traspirante
Sottopiede antibatterico
Suola in gomma antiscivolo
Soffietti elastici
Paracambio
Inseri rifrangenti



Motor cycle boots in real leather
with transpiring membrane
Anti-bacterial inner sole
Non-slip rubber outer sole
Elastic expandables
Gear shield
Refracting inserts

IN VERA PELLE

63997	■ black	size 45	80 16038 63997 8
-------	---------	---------	------------------





polietilene

SILVER TECH

art. 60993-60996

60993	SILVER	SIZE 01	80 16038 60993 3
60996	SILVER	SIZE 02	80 16038 60996 4

- Coprimoto impermeabile silver 100% polietilene con occhielli
- Motorcycle and scooter cover



CUP

art. 60975-60976

60975	dark blue	size 01	80 16038 60975 9
60976	dark blue	size 02	80 16038 60976 6

- Coprimoto/scooter in nylon antistrappo
- Motorcycle and scooter cover



in nylon



CUP LUX

art. 60980-60981

60980	grey	size 01	80 16038 60980 3
60981	grey	size 02	80 16038 60981 0

- Coprimoto/scooter in tessuto felpato
- Motorcycle and scooter cover



felpato

MAGNUM 66

art. 64921

- Antifurto a cavo con chiusura a chiave
- Anti-theft cable with lock and key

Ø 18 mm - 1000 mm

64921 ■ black 80 16038 64921 2



NO PROBLEM

art. 64933

- Antifurto a catena con lucchetto speciale impermeabile
- Anti-theft cable with lock and key

Ø 10x10mm - 900 mm

64933 ■ black 80 16038 64933 5



SAFE +

art. 64910

- Bloccadisco speciale cromato con chiusura antiacqua
- Disk-blocking anti-theft lock

Ø 5,5 mm

64910 ■ CROMATO 80 16038 64910 6



SAFE ++

art. 64911

- Bloccadisco speciale cromato con chiusura antiacqua
- Disk-blocking anti-theft lock

Ø 10 mm

64911 ■ CROMATO 80 16038 64911 1



REMEMBER

art. 64916

- Cavo di segnalazione antifurto inserito
- Cable antitheft signal inserted



150 cm

64916 ■ giallo 80 16038 64001 1

WHEEL

art. 60911

- Kit riparazione pneumatici
- Tyre repair kit



60911 KIT 80 16038 60911 7

PRESTON

art. 60710

- Filtro universale benzina in ABS
- Petrol filter



60710 PRESTON 80 16038 60710 6

POWER

art. 60920
4AH

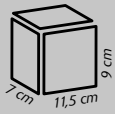

MAX-POWER

art. 60927
4AH

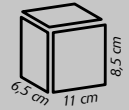

art. 60921
7AH

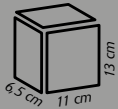

art. 60928
7AH

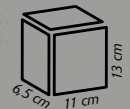

art. 60922
9AH

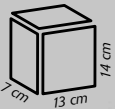

art. 60929
7AH

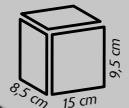

art. 60923
12AH

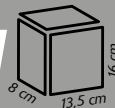

art. 60924
14AH

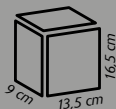

art. 60930
9AH

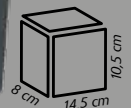

PERFECT

art. 60715

- Interfono
- Motorcycle intercom



60715 ■ black 80 16038 60715 1



COMUNICAZIONE

art. 60716

- Interfono schermato amplificato fonoassorbente
- Acoustic insulation amplified screen intercom



60716 ■ black 80 16038 60716 8



TALK

art. 60717

- Interfono schermato amplificato fonoassorbente
- Acoustic insulation amplified screen intercom



60717 ■ silver 80 16038 60717 5



P15d 12V-35W

- Lampada ricambio
- Spare light bulb

art. 60000

60000 80 16038 60000 8



BA9s 12V-23W

- Lampada ricambio
- Spare light bulb

art. 60005-60007

60005 ■ blue 80 16038 60005 3
60007 ■ orange 80 16038 60007 7



BA9s 12V-5W

- Lampada ricambio
- Spare light bulb

art. 60010-60011

60010 ■ white 80 16038 60010 7
60011 ■ orange 80 16038 60011 4



T10 12V-5W

- Lampada ricambio
- Spare light bulb

art. 60015-60016-60017

60015 ■ white 80 16038 60015 2
60016 ■ orange 80 16038 60016 9
60017 ■ blu 80 16038 60017 6



BAY15d 12V-23/8W

- Lampada ricambio
- Spare light bulb

art. 60025

60025 80 16038 60025 1



BA15s 12V-23W

- Lampada ricambio
- Spare light bulb

art. 60030-60031-60032

60030 ■ white 80 16038 60030 5
60031 ■ blue 80 16038 60031 2
60032 ■ orange 80 16038 60032 9



H7 PX22d

art. 60090

60090 80 16038 60090 9

12V-55W



HALOGEN

BA15s 12V-10W

art. 60040-60041-60042

- 60040 ■ white 80 16038 60040 4
- 60041 ■ blue 80 16038 60041 1
- 60042 ■ orange 80 16038 60042 8

- Lampada ricambio
- Spare light bulb



BAY15d 12V-5/21W

art. 60047

60047 80 16038 60047 2

- Lampada ricambio
- Spare light bulb



T10 12V-5W

art. 60052-60053

- 60052 ■ orange 80 16038 60052 7
- 60053 ■ red 80 16038 60053 4

- Lampada ricambio
- Spare light bulb



LED

BA9s 12V-23W

art. 60061-60062

- 60061 ■ blue 80 16038 60061 9
- 60062 ■ orange 80 16038 60062 6

- Lampada ricambio
- Spare light bulb



LED

T5 12V

art. 60070-60071-60072
60073-60074-60075

- Lampada ricambio
- Spare light bulb

60070	■ white	80 16038 60070 1
60071	■ red	80 16038 60071 8
60072	■ blue	80 16038 60072 5
60073	■ green	80 16038 60073 2
60074	■ pink	80 16038 60074 9
60075	■ orange	80 16038 60075 6



H1 12V

art. 60081-60082

60081	■ Platinum white	80 16038 60081 7
60082	■ Platinum blue	80 16038 60082 4

- Lampada ricambio
- Spare light bulb



**HALOGEN
XENON**



H4 12V

art. 60086

60086	■ Platinum white	80 16038 60086 2
-------	------------------	------------------

- Lampada ricambio
- Spare light bulb



**HALOGEN
XENON**



H7 12V

art. 60091-60092

60091	■ Platinum white	80 16038 60091 6
60092	■ Platinum blue	80 16038 60092 3

- Lampada ricambio
- Spare light bulb



**HALOGEN
XENON**



SPYKO

art. 60106-60107-60108-60109-60110

- Coppia luci led strobo con regolatore
- Pair of stroboscopic led lights with light controller

60106	■	blue	TARGA	80 16038 60106 7
60107	■	red	TARGA	80 16038 60107 4
60108	■	green	TARGA	80 16038 60108 1
60109	■	violet	TARGA	80 16038 60109 8
60110	■	white	TARGA	80 16038 60110 4



TWIN

art. 60151-60154

- Coppia luci led orientabili adesive
- Adhesive lights with leds

60151	■	white	12V	80 16038 60151 7
60154	■	green	12V	80 16038 60154 8



DOUBLE

art. 60142

- Coppia luci led adesive
- Adhesive lights with leds

60142	■	green	12V	80 16038 60142 5
-------	---	-------	-----	------------------



SHINE

art. 60360-60361-60362
60363-60364-60365

- Proiettore luminoso
- Projector

60360	■	red blue	12V	80 16038 60360 3
60361	■	white blue	12V	80 16038 60361 0
60362	■	blue	12V	80 16038 60362 7
60363	■	white	12V	80 16038 60363 4
60364	■	green	12V	80 16038 60364 1
60365	■	red	12V	80 16038 60365 8



FIRST

art. 60337-60338-60339-60340

- Luci led sottoscocca
- Led lights for frame for frame underside

60337	■ red	12V	80 16038 60337 5
60338	■ green	12V	80 16038 60338 2
60339	■ violet	12V	80 16038 60339 9
60340	■ white	12V	80 16038 60340 5



ALLARME MOTO

art. 60700



- Motorcycle alarm system

60700	■ black	80 16038 60700 8
-------	---------	------------------



FLASHING

art. 60145-60146-60147-60148-60149

- Coppia luci led strobo adesive
- Pair of stroboscopic adhesive led lights

60145	■	blue	12V	80 16038 60145 6
60146	■	red	12V	80 16038 60146 3
60147	■	green	12V	80 16038 60147 0
60148	■	white	12V	80 16038 60148 7
60149	■	orange	12V	80 16038 60149 4

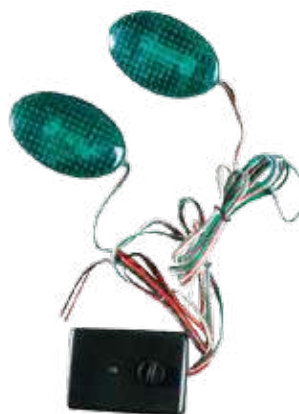

FUTURE

art. 60321-60323-60324

- Coppia luci direzionali 16 led adesive
- Pair adhesive directional lights 16 led

60321	■	orange	12V	80 16038 60321 4
60323	■	red	12V	80 16038 60323 8
60324	■	green	12V	80 16038 60324 5



STRANGE

art. 60295-60296-60297-60298-60299

- Coppia Luci led tubolari 17 cm
- Led lights

60295	■	blue	12V	80 16038 60295 8
60296	■	red	12V	80 16038 60296 5
60297	■	green	12V	80 16038 60297 2
60298	■	violet	12V	80 16038 60298 9
60299	■	white	12V	80 16038 60299 6



IDEA

art. 60130-60131-60132-60133-60134

- Coprivalvole pneumatico luminoso a led
- Pair of led lights with pneumatic valves

60130	■	blue	80 16038 60130 2
60131	■	red	80 16038 60131 9
60132	■	green	80 16038 60132 6
60133	■	violet	80 16038 60133 3
60134	■	white	80 16038 60134 0



CRIME

art. 60160-60161-60162-60163-60164

- Neon luminoso
- Neon Light

60160	■	blue	80 16038 60160 9
60161	■	green	80 16038 60161 6
60162	■	white	80 16038 60162 3
60163	■	violet	80 16038 60163 0
60164	■	red	80 16038 60164 4



SUNRISE

art. 60115-60116-60117

- Coppia strisce flessibili a 3 led adesive
- Pair of fl exible adhesive strips with 3 leds each

60115	■	blue	80 16038 60115 9
60116	■	green	80 16038 60116 6
60117	■	white	80 16038 60117 3



SURVIVOR

art. 60120-60121-60122

- Striscia fl essibile adesiva a 5 led
- Flexible adhesive strip with 5 leds

60120	■	blue	80 16038 60120 3
60121	■	green	80 16038 60121 0
60122	■	white	80 16038 60122 7



DEVIL

art. 60125-60126-60127

- Striscia fl essibile adesiva a 5 led
- Flexible adhesive strip with 5 leds

60125	■	blue	80 16038 60125 8
60126	■	green	80 16038 60126 5
60127	■	white	80 16038 60127 2



DOUBLE LAMP

art. 60251-60252-60253
60254-60255

- Coppia luci led adesive
- Adhesive lights with leds

60251	■	blue	80 16038 60251 4
60252	■	green	80 16038 60252 1
60253	■	red	80 16038 60253 8
60254	■	white	80 16038 60254 5
60255	■	orange	80 16038 60255 2



KNOW

art. 60103

- Termometro luminoso led
- Limonous thermometer

60103	■	blue	80 16038 60103 6
-------	---	------	------------------



SNAIL

art. 60310-60311-60312-60313

- Coppia luci 2 led adesive
- Adhesive lights with 2 leds

60310	■	blue	80 16038 60310 8
60311	■	white	80 16038 60311 5
60312	■	red	80 16038 60312 2
60313	■	violet	80 16038 60313 9



BRIGHT

art. 60290-60291

- Luci targa decorative per targa a 12 led
- 12 Led lights for number plate

60290	■	red	80 16038 60290 3
60291	■	blue	80 16038 60291 0



STRANGE

art. 60315-60316-60317
60318-60319-60320

- Proiettore luminoso a led
- Switch with lights

60315		multicolors	80 16038 60315 3
60316		blue	80 16038 60316 0
60317		white	80 16038 60317 7
60318		red	80 16038 60318 4
60319		green	80 16038 60319 1
60320		violet	80 16038 60320 7



YEAH

art. 60345-60346-60347-60348

- Luce adesiva con led + luce bianca strobo
- Adhesive lights with leds + white strobe light

60345		blue	80 16038 60345 0
60346		orange	80 16038 60346 7
60347		red	80 16038 60347 4
60348		white	80 16038 60348 1



WIZARD

art. 60330-60331-60332
60333-60334-60335

- Coppia luci adesive a 3 led
- Pair of adhesive lights with 3 leds each

60330		blue	80 16038 60330 6
60331		red	80 16038 60331 3
60332		green	80 16038 60332 0
60333		orange	80 16038 60333 7
60334		white	80 16038 60334 4
60335		violet	80 16038 60335 1



OK

art. 60112

- Comando a distanza per luci neon (centralina automatica)
- Remote system for neon-lighting

60112		black	80 16038 60112 8
-------	--	-------	------------------



**COMANDO A DISTANZA PER LUCI NEON
(CENTRALINA AUTOMATICA)**



ATTACK

art. 60370-60371-60372
60373-60374

- Luci targa e led decorative regolabili
- Led lights for number plate

60370	■	blue	80 16038 60370 2
60371	■	white	80 16038 60371 9
60372	■	red	80 16038 60372 6
60373	■	green	80 16038 60373 3
60374	■	violet	80 16038 60374 0

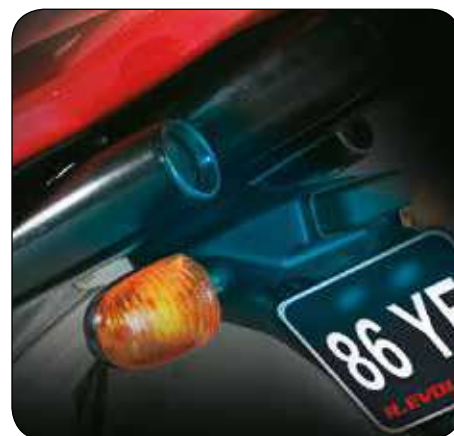

SATURN

art. 60382-60383-60384-60385-60386

- Luci targa decorative per targa a led
- Led lights for number plate

60382	■	blue	80 16038 60382 5
60383	■	white	80 16038 60383 2
60384	■	red	80 16038 60384 9
60385	■	green	80 16038 60385 6
60386	■	violet	80 16038 60386 3



SNAKE

art. 60390-60391-60392-60393-60394

- Luci targa decorative per targa a led
- Led lights for number plate

60390	■	blue	80 16038 60390 0
60391	■	white	80 16038 60391 7
60392	■	red	80 16038 60392 4
60393	■	green	80 16038 60393 1
60394	■	violet	80 16038 60394 8



SLICK

art. 60399

- Coppia luci led adesive
- adhesive lights with leds

60399	■	red	80 16038 60399 3
-------	---	-----	------------------



VISION PLUS

art. 60643

- Coppia specchi retrovisori universali per moto e scooter
- Rear-view mirrors

60643 ■ black 80 16038 60643 7



OVER

art. 60618

- Manopole scooter
- Pair of handgrips

60618 ■ black 80 16038 60618 5



sx Ø 22mm - dx Ø 25mm

GHOST

art. 60619-60620-60621-60622

- Manopole scooter
- Pair of handgrips

60619 ■ chromed 80 16038 60619 2
60620 ■ black 80 16038 60620 8
60621 ■ blue 80 16038 60621 5
60622 ■ red 80 16038 60622 2



sx Ø 22mm - dx Ø 25mm



FORCE 8

- 4 pz. copridadi anodizzati
- Bolt cover

art. 60591-60592-60593

60591	chromed	80 16038 60591 1
60592	blue	80 16038 60592 8
60593	red	80 16038 60593 5



Ø 8 mm



FORCE 12

Ø 12 mm

art. 60594-60595-60596

60594	chromed	80 16038 60594 2
60595	blue	80 16038 60595 9
60596	red	80 16038 60596 6

FORCE 14

Ø 14 mm

art. 60597-60598-60599

60597	chromed	80 16038 60597 3
60598	blue	80 16038 60598 0
60599	red	80 16038 60599 7



ZENITH

- Cp. stabilizzatori manubrio
- Pair of handlebar stabilizers end pieces

art. 60780-60781
60782-60783

60780	chromed	80 16038 60780 9
60781	black	80 16038 60781 6
60782	blue	80 16038 60782 3
60783	red	80 16038 60783 0



INDY

- Cp. stabilizzatori manubrio
- Pair of handlebar stabilizers end pieces

art. 60784-60785-60787

60784	chromed	80 16038 60784 7
60785	black	80 16038 60785 4
60787	red	80 16038 60787 8



RACE

- Coprivalvole in alluminio
- 2-piece valve cover

art. 60761-60763

60761	black	80 16038 60761 8
60763	red	80 16038 60763 2



CRISTAL

- Coprivalvole in alluminio
- 2-piece valve cover

art. 60768-60769-60771

60768	chromed	80 16038 60768 7
60769	black	80 16038 60769 4
60771	red	80 16038 60771 7



YEH

- Coprivalvole in alluminio
- 2-piece valve cover

60764	chromed	80 16038 60764 9
60765	black	80 16038 60765 6
60766	blue	80 16038 60766 3
60767	red	80 16038 60767 0

art. 60764-60765
60766-60767



MUFFLER

art. 60685

- Portachiavi in alluminio
- Aluminium key holder



BOSS

- Bulloni decorativi
- Decoration bolt

60600	chromed	80 16038 60600 0
60601	red	80 16038 60601 7
60602	blue	80 16038 60602 4

art. 60600-60601-60602



SHOCK

art. 60686

- Portachiavi in alluminio
- Aluminium key holder



INK

- Portachiavi luminoso
- Lighting key holder

art. 60687-60688-60689
60690-60691

60687	blue led	80 16038 60687 1
60688	red led	80 16038 60688 8
60689	green led	80 16038 60689 5
60690	violet led	80 16038 60690 1
60691	white led	80 16038 60691 8



HYDRO

art. 60830-60831-60832
 60833-60834

- Porta tagliando assicurazione
- Tax disc holder

60830	chromed	80 16038 60830 1
60831	black	80 16038 60831 8
60832	blue	80 16038 60832 5
60833	red	80 16038 60833 2
60834	carbon	80 16038 60834 9

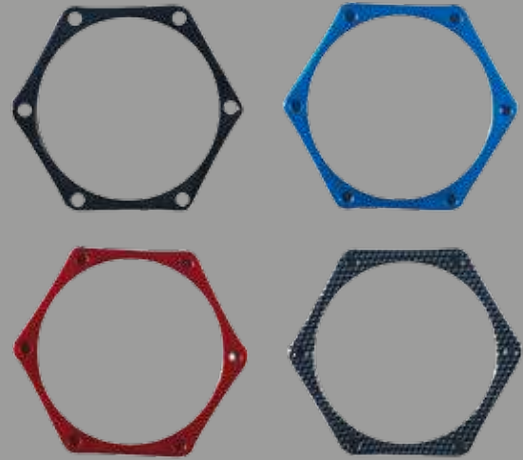

START

art. 60858-60859

- Pedaliera antiscivolo
- Non-slip pedal

60858	chromed	80 16038 60858 5
60859	red	80 16038 60859 2



X-LITE

- Filtro universale benzina in alluminio
- Petrol filter

art. 60711

colori assortiti



AIR-CLEAN

- Mini filtro aria sport
- Mini sports air filter

art. 60712-60714

60712	red	80 16038 60712 0
60714	blue	80 16038 60714 4



YORK

- Coprifilo cromato
- Wirecover

60810		chromed	80 16038 60810 3
60811		blue	80 16038 60811 0
60812		red	80 16038 60812 7

art. 60810-60811-60812



MUFFLER

art. 60816

- Profilo cromato
- Chromed profile



VISUAL

- Pellicola colorata adesiva fanali e cupolini
- Motorcycle and scooter headlight film

60801		multicolor	80 16038 60801 1
60802		yellow	80 16038 60802 8

art. 60801-60802



REFLECTING

- Catarifrangenti adesivi
- Colorful reflectors

60820		red	80 16038 60820 2
60821		white	80 16038 60821 9
60822		blue	80 16038 60822 6
60823		green	80 16038 60823 3
60824		orange	80 16038 60824 0

art. 60820-60821-60822
60823-60824



REFLEX

- Catarifrangenti adesivi
- Colorful reflectors

60825		red	80 16038 60825 7
60826		white	80 16038 60826 4
60827		blue	80 16038 60827 1
60828		orange	80 16038 60828 8
60829		green	80 16038 60829 5

art. 60825-60826-60827
60828-60829



FREE STYLE

60673		black	80 16038 60673 4
--------------	--	-------	------------------

art. 60673



- Protezione serbatoio adesiva
- Tank pad



TRIM

- Bordino coprifiniture ad incastro
- Finishing edging

60841	■ black	80 16038 60841 7
60842	■ blue	80 16038 60842 4
60843	■ red	80 16038 60843 1
60844	■ carbon	80 16038 60844 8

art. 60841-60842
60843-60844



OUT FLUÒ

- Strisce adesive luminose per ruote
- Adhesive and refracting

60682	■ red	80 16038 60682 6
60683	■ yellow	80 16038 60683 3

art. 60682-60683



GOGO 450ml

- Gonfia e ripara pneumatici
- Inflator and sealer

art. 60719



NO FOG 75ml

- Antiappannante visiere e cupolini
- Helmet visor de-fogger

art. 60739

art. 60729
in blister



FILM 75ml

- Protettivo e lucidante plastica e carene
- Plastic protector

art. 60734



WATERPROOF

- Impermeabilizzante per tute guanti scarpe e tutto l'abbigliamento
- Weatherproofing for suits gloves shoes and all clothing

art. 60737 75ml



SLEEVE 75ml

art. 60736



SHADOW

art. 60738 75ml



- Pulitore e lucidante caschi
- Helmet cleaner

art. 60728
in blister



CLEAN

art. 60745

- Panno lucidante/pulente in microfibra trattata
- Microfibre polishing and cleaning glove



LUXURY

art. 60746

- Guanto lucidante/pulente in microfibra trattata
- Microfibre polishing and cleaning glove







illuminazione

lighting



led
lampeggiante

96311

- Fanalino anteriore 2 funzioni
- 2 functions front lamp
- Phare avant deux fonctions
- Scheinwerfer zwei Funktionen
- Faro anterior 2 funciones

Master 96 - Inner 12



8 016038 963110



3 led bianchi
5 funzioni

96313

- Proiettore anteriore alogeno
- Front Led + alogene Lamp
- Projecteur anterior a leds blancs 5 fonctions + phare halogene avant
- Vorderscheinwerfer mit weissen Leuchtdioden mit 5 + Halogenscheinwerfer
- Projector anterior de led blancos 5 funciones + faro anterior halogeno

Master 60 - Inner 12



8 016038 963134



luce alogena
bianca

96314

- Fanalino anteriore 4 funzioni
- Front white led projector 4 func.
- Projecteur anterior a leds blancs
- Vorderscheinwerfer mit weissen Leuchtdioden
- Projector anterior de led blancos

Master 60 - Inner 12



8 016038 963141



96318

- Fanale anteriore alogeno
- Front alogen lamp
- Projecteur anterior a leds blancs 5 fonctions + phare halogene avant
- Vorderscheinwerfer mit weissen Leuchtdioden mit 5 + Halogenscheinwerfer
- Projector anterior de led blancos 5 funciones + faro anterior halogen

Master 60 - Inner 12



8 016038 963189



5 led
lampeggiante



FANALI ANTERIORI

led
lampeggiante



96312

- Fanalino posteriore 2 funzioni
- 2 functions rear lamp
- Phares arriere 2 fonctions
- Rückleuchte mit 2 Funktionen
- Faro posterior 2 funciones

Master 96 - Inner 12



96316

- Fanalino posteriore 4 funzioni
- Rear red led projector 4 func.
- Feu posterieur a leds rouges
- Rückstrahler mit roten Leuchtdioden
- Projector posterior de led rojo

Master 60 - Inner 12



5 led
lampeggiante



96330

- Fanalino posteriore a luce rossa
- Rear lamp for bicycle
- Phare arriere pour velo
- Flagship für Fahrradheckträger
- Faro trasero para bicicleta

Master 60 - Inner 12



funziona con la
dinamo inserita



96333

- Riflettore posteriore rifrangente
- Rear reflector with carrier connection
- Phare arriere avec connexion au porte-bagages
- Rücklicht Zusammenhang mit Reisegepäck
- Faro posterior conectado portapaquetes

Master 96 - Inner 12



ottima rifrangenza
posteriore

FANALI POSTERIORI





96290

- Coppia lampadine ricambio
- 2 spare light bulbs front/rear
- 2 ampoules de rechange
- 2 Ersatzlampen
- 2 bombillas de repuesto

Master 96 - Inner 12



8 016038 962908



per faro
anteriore
e posteriore



LAMPADINE

**2 pezzi
universale**



96332

- Catarifrangenti per ruote Luxury
- Luxury reflectors for bicycle wheels
- Lot de 2 réflecteurs homologues pour roues de velo
- Lot von 2 Reflektoren Kollegen Laufräder
- 2 catadioptricos homologado para ruedas bicicleta

Master 96 - Inner 12

8 016038 963325



**2 pezzi
universale**



96334

- Catarifrangenti ruote
- Reflectors for bicycle wheels
- Lot de 2 réflecteurs pour roues de velo
- Lot von 2 Reflektoren für Laufräder
- 2 catadioptricos para ruedas bicicleta

Master 96 - Inner 12

8 016038 963349



**2 pezzi
universale**



96350

- Catarifrangenti anteriore e posteriore
- Set of front+ rear reflectors + holders
- 2 réflecteurs pcs blanc et rouge
- 2 Stück Reflektoren weiß und rot
- 2 reflectores piezas blancas y rojas

Master 96 - Inner 12

8 016038 963509



**4 pezzi
assortiti**



96975

- Catarifrangenti ruota
- Reflectors for byke wheels
- Réflecteurs pour roues de velo
- Radspeichenreflektoren
- Catadioptricos para ruedas bicicleta

Master 96 - Inner 12

8 016038 969754



Bottari
BIKE
BIMBOLINE

CATARIFRANGENTI



Set 2 fanali
fronte e retro



luce bianca e rossa

96320

- Set 2 fanali fronte e retro
- Lamp set (front and rear)
- Lampe set (avant et arrière)
- Lamp Set (vorne und hinten)
- Lámpara conjunto (delantero y trasero)

Master 60 - Inner 12



5 led
4 funzioni



2 led
4 funzioni

luce bianca e rossa

96322

- Set 2 fanali fronte e retro
- Lamp set (front and rear)

- Lampe set (avant et arrière)
- Lamp Set (vorne und hinten)
- Lámpara conjunto (delantero y trasero)

Master 60 - Inner 12



Set 2 fanali
fronte e retro



SET 2 FANALI FRONTE E RETRO



accessori accessories





96910

- Campanello metallo
- Coloured bell

- Sonette couleur
- Fahrradklingel
- Timbre coloreado

Master 96 - Inner 12



8 016038 969105



96911

- Campanello colorato mini bell
- Coloured bell

- Sonette couleur
- Fahrradklingel
- Timbre coloreado

Master 96 - Inner 12



8 016038 969112



96913

- Campanello metallo
- Coloured bell

- Sonette couleur
- Fahrradklingel
- Timbre coloreado

Master 96 - Inner 12



8 016038 969136



96914

- Campanello metallo
- Metal bell

- Métal Bell
- Bell Metall
- Campana de metal

Master 60 - Inner 12



8 016038 969143





96915

- Campanello assortito colorato
- Coloured bell
- Sonette couleur
- Fahrradklingel
- Timbre coloreado

Master 96 - Inner 12



96916

- Campanello metallo
- Metal bell
- Métal Bell
- Bell Metall
- Campana de metal

Master 96 - Inner 12





96989

- Specchio bicicletta uomo/donna classico
- Man and woman classic bike mirror

- Miroir vélo
- Fahrrad Spiegel
- Bicicleta espejo

Master 96 - Inner 12



8 016038 969891



96976

- Specchietto universale
- Adjustable mirror adapts to all handlebars with reflector

- Rétroviseur réglable s'adaptant à tous les types de guidons fourni avec un catadioptre
- Regulierbarer Spiegel an alle Lenker Anpassbar mit Katzenauge
- Espejo ajustable adaptable a todos los manubrios con catafaros

Master 48 - Inner 12



8 016038 969761

Bottari
BIKE
BIMBOLINE



96135

- 2 manopole in gomma
- Sport Handlebars Grips

- Lot de 2 gris pour guidon
- Universal-Gummigriffe
- 2 puños manillar

Master 60 - Inner 10



8 016038 961352



universali



96136

- 2 manopole classiche
- Classic handlebars grips

- Lot de 2 gris pour guidon
- Universal-Gummigriffe
- 2 puños manillar

Master 60 - Inner 10



8 016038 961369



SPECCHIETTI E MANOPOLE



96137

- Manopole in similgel
- Pair of similgel handgrips

- Lot de 2 gris pour guidon
- Universal-Gummigriffe
- 2 puños manillar

Master 60 - Inner 10



8 016038 961376



96150

- Appendici manubrio
- Pair of aluminum handlebar extensions

- Extensions de guidon
- Erweiterungen für Lenker
- Extensiones para el manillar

Master 60 - Inner 6



8 016038 961505



96925

- Portaborraccia
- Lightweight aluminum bottle

- Aluminium thermos
- Aluminium Isolierflasche
- Aluminio termo

Master 96 - Inner 12



8 016038 969259



MANOPOLE-APPENDICI-PORTABORRACCIA





96920

- Kit portaborraccia lega + borraccia
- Water bottle clip + water BOTTLE

- Kit porte gourde + gourde
- Set Trinkflaschenhalter + Trinkflasche
- Kit portacantimplora + cantimplora

Master 48 - Inner 12



colori assortiti



96922

- Kit portaborraccia lega + borraccia
- Water bottle clip + water BOTTLE

- Kit porte gourde + gourde
- Set Trinkflaschenhalter + Trinkflasche
- Kit portacantimplora + cantimplora

Master 48 - Inner 12



96924

- Borraccia in alluminio termica
- Aluminium thermos flask

- Gourde thermique en aluminium
- Aluminiumthermos
- Borracha térmica en aluminio

Master 20 - Inner 10



mantiene le temperature

96971
Borraccia termica in alluminio •
Alluminium thermos flask •

- Gourde thermique en aluminium
- Aluminiumthermos
- Borracha térmica en aluminio

Master 30 - Inner 6



Bottari
BIKE
BIMBOLINE



colori assortiti



BORRACCE





96972

- Trombetta universale
- Trumpets Universal bicycle

- Trompettes universal vélo
- Trompeten Universal Fahrrad
- Trompetas universal de la bicicleta

Master 50 - Inner 10



8 016038 969723



96973

- Trombetta universale
- Trumpets Universal bicycle

- Trompettes universal vélo
- Trompeten Universal Fahrrad
- Trompetas universal de la bicicleta

Master 50 - Inner 10



8 016038 969730



soggetti assortiti



colori assortiti



96974

- Decorazioni ruota
- Wheel decorations

- Décorations roue
- Raddekorationen
- Decoraciones rueda

Master 96 - Inner 12



8 016038 969747





96990

- Ciclocomputer universale 9 funzioni
- Bike computer 9 functions
- Ordinateur de vélo 9 fonctions
- Fahrrad-Computer mit 9 Funktionen
- Bicicleta de computadora 9 funciones

Master 60 - Inner 12



8 016038 969907



9 funzioni
professionale



96991

- Ciclocomputer universale 12 funzioni
- Bike computer 12 functions
- Ordinateur de vélo 12 fonctions
- Fahrrad-Computer mit 12 Funktionen
- Bicicleta de computadora 12 funciones

Master 60 - Inner 12



8 016038 969914



12 funzioni
professionale



96992

- Ciclocomputer wireless universale
- Bike computer 16 functions
- Ordinateur de vélo 16 fonctions
- Fahrrad-Computer mit 16 Funktionen
- Bicicleta de computadora 16 funciones

Master 60 - Inner 12



8 016038 969921

senza
fili

16 funzioni
wireless
professionale



CICLOCOMPUTER

- Sella ciclo
 - Universal seat soft-line
-
- Selle universelle soft-line
 - Universal-Sportssattel Soft-Line
 - Sillin universale soft-line

touring



96180

Master 24 - Inner 6



8 016038 961802

con catarifrangente



96187

Master 18 - Inner 6



8 016038 961871



sport

- Sella ciclo
- Universal seat soft-line
- Selle universelle soft-line
- Universal-Sportssattel Soft-Line
- Sillin universale soft-line



mtb



con catarifrangente



SELLE



96192

- Coprisella universale
- Universal saddle cover
- Couvre selle universel
- Universal Sitzbezüge
- Cubresillin universal

Master 60 - Inner 12

8 016038 961925

elasticizzato
impermeabile



IN GEL

touring



96190

- Coprisella touring in gel
- Gel saddle cover
- Couvre-selle gel
- Sattelbezug Gel
- Cubre sillin gel

Master 24 - Inner 12

8 016038 961901



mtb

96191

- Coprisella mtb in gel
- Gel saddle cover
- Couvre-selle gel
- Sattelbezug Gel
- Cubre sillin gel

Master 24 - Inner 12

8 016038 961918



COPRISELLA



96200

- Dinamo universale
- Universal dynamo

- Dynamo universelle
- Universal Dynamo
- Universal-dynamo

Master 60 - Inner 12



universale



96201

- Dinamo cromata
- Universal chrome dynamo

- Dynamo universelle
- Universal Dynamo
- Universal-dynamo

Master 60 - Inner 12



universali



96030

- Coppia pedali con catarifrangenti
- 1 pair of pedals with reflectors

- Lot de pedale de réflecteurs
- Paar Rutschfeste Pedale
- Pedal de reflectores

Master 48 - Inner 6



96031

- Coppia pedali con catarifrangenti
- 1 pair of pedals with reflectors

- Lot de pedale de réflecteurs
- Paar Rutschfeste Pedale
- Pedal de reflectores

Master 48 - Inner 6



mtb



DINAMO-PEDALI



portaggio e protezione

car rack and protection



96880

- Cestino in metallo con ganci
- Black metal basket whit hooks

- Panier métallique noir avec crochets
- Schwarz Metallgepäckkorb für Fahrräder mit Haken
- Cesta metálica negra con gancho

Master 20 - Inner 10

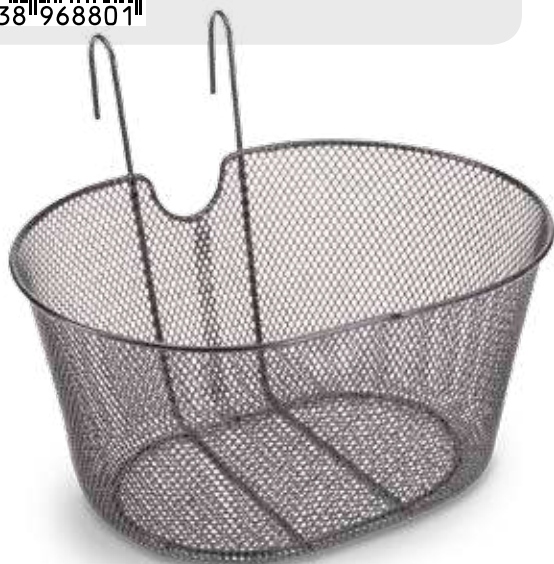

96882

- Cestino in metallo con ganci
- Black metal basket whit hooks

- Panier métallique noir avec crochets
- Schwarz Metallgepäckkorb für Fahrräder mit Haken
- Cesta metálica negra con gancho

Master 20 - Inner 10



96884

- Cestino posteriore metallo
- Metallic basket

- Panier métallique
- Metallgepäckkorb für Fahrräder
- Cesta metálica

Master 10



CESTINI



96890

- Portapacchi anteriore con fermatutto
- Carrier for bike
- Porte-bagages
- Gepäckträger
- Portaequipajes

Master 24 - Inner 6

8 016038 968900

anteriore

in metallo verniciato antiruggine

96891

- Portapacchi posteriore in metallo
- Carrier for bike
- Porte-bagages
- Gepäckträger
- Portaequipajes

Master 24 - Inner 6

8 016038 968917

posteriore

96881

- Cestino in metallo anteriore
- Metal basket
- Panier métallique
- Metallgepäcckorb für Fahrräder
- Cesta metálica

Master 20 - Inner 10

8 016038 968818



PORTAPACCHI

96960

- Seggiolino posteriore con attacco al telaio
- Rear seat frame attachment

- Siege posterieur attache au chassis
- Hinterer Sitz mit Rahmenbefestigung
- Sillita posterior conexión al bastidor

Master 6



8 016038 969600



posteriore

omologato
secondo
le ultime
Normative
Europee

96965

- Seggiolino anteriore con attacco al telaio
- Front seat frame attachment

- Siege anterieur attache au chassis
- Vorderer Sitz mit Rahmenbefestigung
- Sillita anterior conexión al bastidor

Master 10



8 016038 969655



anteriore

omologato
secondo
le ultime
Normative
Europee

96862

- Parabrezza anti-pioggia e antivento
- Pvc windscreen rainproof and windproof

- Pare-brise en pvc anti-pluie et anti-vent
- Pvc Windschutzscheibe undurchlässig und luftdicht
- Parabrisa de pvc anti-lluvia y anti-viento

Master 6 - Inner 3



8 016038 968627

in scatola/box

per la protezione
dei bambini



SEGGIOLINI-PARABREZZA



96970

- Borsetta sottosella
- Saddle bag in assorted colours

- Trousse de selle colorie assortie
- Werkzeugtasche für Fahrräder
- Bolsa bajo sillin colores surtidos

Master 50 - Inner 10



8 016038 969709



96981

- Spallaccio mtb
- Shoulder mtb

- Épaule VTT
- Schulter MTB
- Hombro MTB

Master 50 - Inner 10



8 016038 969815



96980

- Borsa anteriore con porta cartina
- Front bag with map holder

- Sac avant avec support de carte
- Fronttasche mit Kartentasche
- Bolsa de frente con el titular del mapa

Master 50 - Inner 10



8 016038 969808



impermeabile





96125

- Cavalletto in alluminio
- Aluminium bike stand with plate
- Bequille en aluminium avec plateau
- Fahrradseitenständer
- Caballete en aluminio con plancha

Master 48 - Inner 12



alluminio



96127

- Cavalletto regolabile
- Adjustable bike stand with plate
- Bequille en aluminium avec plateau
- Fahrradseitenständer
- Caballete en aluminio con plancha

Master 48 - Inner 12



regolabile



CAVALLETTI





96906

- Copri bicicletta universale
- Universal bike cover 200x100cm

- Vélo de couverture universelle
- Fahrrad universelle Abdeckung
- Cobertura universal de bicicletas

Master 48 - Inner 12



**200x100
resistente**

COPPIA PARAFANGHI ANTERIORE/ POSTERIORE
UNIVERSAL FRONT AND REAR MUDGUARDS

UNIVERSALE PER MTB E CITYBIKE

Prodotto selezionato, testato e certificato in Italia

botari@bottari.it - www.botari.it

96860

- Coppia parafanghi anteriore/posteriore
- Universal front and rear mudguards
- Gardes-boue antérieurs et postérieurs universel
- 2 universal Kotschützer vorn/hinten
- Juego de guardabarros, anterior y posterior universal

Master 10



- 1 Gardes-boue antérieurs et postérieurs universel
- 2 universal kotschützer vorn/hinten
- 3 Juego de guardabarros, anterior y posterior universal
- 4 Para-choques dianteiros e traseiros universal
- 5 Blázniki předních i tylne univerzálne
- 6 Universal předních a zadních

96870

- Corda elastica ferma carico
- Elasticized cord for luggage racks
- Corde élastique pour porte-bagages
- Elastisches Seil für Gepäckträger
- Cuerda elástica para trasportin

Master 96 - Inner 12



PROTEZIONE



accessori **freno**
brake accessories 417



v-brake block
professionali



96048

- 2 pz. pattini freni
- 2 pcs of mtb brake pads
- Lot de 2 patins de frein vtt
- 2 Fahrradbremsslötze
- 2 pastillas de freno mtb

Master 96 - Inner 12



8 016038 960485



mtb
universali



96046

- 2 pz. pattini freni
- 2 pcs of mtb brake pads
- Lot de 2 patins de frein vtt
- 2 mtb-Bremsslötze
- 2 pastillas de freno mtb

Master 96 - Inner 12



8 016038 960461



adattabili a qualsiasi bicicletta



96045

- 4 pezzi pattini freni
- 4 pcs of brake pads
- Lot de 4 patins de frein
- 4 Fahrradbremsslötze
- 4 pastillas de freno

Master 96 - Inner 12



8 016038 960454



universali



96082

- Kit freni cantilever
- Front/rear aluminium cantilever kit
- Kit de frein cantilever en aluminium avant/arriere
- Satz Alubremsen vorn/hinten
- Juego frenos aluminio delantero/trasero cantilever

Master 60 - Inner 6



8 016038 960829



PATTINI FRENO



96055 rivestiti teflon

- Kit per freno anteriore e posteriore
- Front/rear white brake-wires
- Lot de 2 cables de frein avant/arriere
- Vorne/hinten Brake Leitungen
- 2 cables de freno delantero/trasero

Master 96 - Inner 12



84cm ant
173cm post



96056 rivestiti teflon

- Kit per freno anteriore e posteriore
- Front/rear black brake-wires
- Lot de 2 cables de frein noire avant/arriere
- Vorne/Hinten Schware Brake Leitungen
- 2 cables de freno delantero/trasero negro

Master 96 - Inner 12



84cm ant
173cm post



96060 rivestiti teflon

- Kit per freno anteriore e posteriore
- 2 pcs of front/rear black brake-wires
- Lot de 2 cables de frein noire avant/arriere
- Vorne/hinten Schware Brake Leitungen
- 2 cables de freno delantero/trasero negro

Master 96 - Inner 12



mtb
84cm ant
173cm post



FILI FRENO CON GUAINA





85cm
mtb/city bike

96062

- Coppia fili freni anteriori
- Pair of front brake cables
- Paire de cables de freins pour l'avant
- Vorderesbrimsleitungspaar
- Par de cables para frenos anteriores

Master 96 - Inner 12



8 016038 960621



155cm
mtb/city bike

96063

- Coppia fili freni posteriori
- Pair of rear brake cables
- Cables de freins arrières
- Hinteres Bremsleitungspaar
- Cables para frenos posteriores

Master 96 - Inner 12



8 016038 960638



85cm
racing

96064

- Coppia fili freni anteriori
- Pair of front brake cables
- Paire de cables de freins pour l'avant
- Vorderesbrimsleitungspaar
- Par de cables para frenos anteriores

Master 96 - Inner 12



8 016038 960645



140cm
racing

96065

- Coppia fili freni posteriori
- Pair of rear brake cables
- Paire de cables de freins arrières
- Hinteres Profibrmsleitungspaar
- Par de cables para frenos posteriores

Master 96 - Inner 12



8 016038 960652



FILI FRENO SENZA GUAINA



85cm
sport



96066

- Coppia fili freni anteriori
- Pair of front brake cables
- Paire de cables de freins pour l'avant
- Vorderes Profibremslleitungspaar
- Par de cables para frenos anteriores

Master 96 - Inner 12



8 016038 960669



175cm
sport



96067

- Coppia fili freni posteriori
- Pair of rear brake cables
- Paire de cables de freins arrières
- Hinteres Profibremslleitungspaar
- Par de cables para frenos posteriores

Master 96 - Inner 12



8 016038 960676



FILI FRENO SENZA GUAINA





96120

- Leve freni in resina
- 2pcs of resin brake levers
- Lot de deux leviers de frein en resine
- 2 Universal Alubremssgriffe
- 2 frenos de resina

Master 48 - Inner 12



8 016038 961208



universali

96100

- Leve freni in alluminio anodizzato
- 2pcs of aluminium brake levers
- Lot de deux leviers de frein en aluminium
- 2 Universal Alubremssgriffe
- Juego frenos aluminio delantero/trasero

Master 48 - Inner 6



8 016038 961000



kit freni v-brake
resina super leggera

96080

- Kit freni v-brake anteriore e posteriore
- Front/rear aluminium v-brake kit
- Kit de frein en v en aluminium avant/arriere
- Satz Alubremsen Vorn/Hinten
- Juego frenos aluminio delantero/trasero v-brake

Master 48 - Inner 6



8 016038 960805



LEVE FRENI



manutenzione e riparazione

maintenance and repair



misure di chiavi esagonali esterne
chiavi esagonali interne
cacciaviti a croce e a taglio-coltellino-leva chiodi



96501

- Kit chiavi multiuso
- Kit keys multipurpose
- Kit touches polyvalent
- Keys Vielseitige Kit
- Claves versátil kit

Master 96 - Inner 12



8 016038 965015



universale



96508

- Chiave multifunzione 10 in 1
- Multi tool 10 in 1
- 10 en 1 outil de cycle
- 10 in 1 Zyklus Werkzeug
- 10 en 1 herramienta de ciclo

Master 96 - Inner 12



8 016038 965084



misura-size 1,5 - 2 - 2,5 - 3 - 4 - 5 - 6 mm



96511

- Set chiavi esagonali
- Multi tool hex-wrench
- Outil multi-clé hexagonale
- Multi-Tool Hex-Schlüssel
- Multi-llave hexagonal

Master 96 - Inner 12



8 016038 965114



KIT CHIAVI RIPARAZIONE

universale
3 pz

universale
3 pz



96540

- Chiavi leva gomme metallo
- Tyre iron levers
- Lot de 3 leviers en fer pour pneus
- Satz 3 Reifenabzieher aus Metall
- 3 llaves de acero quita cámaras

Master 96 - Inner 12



8 016038 965404



96545

- Chiavi leva gomme nylon
- Tyre nylon levers
- Lot de 3 leviers en nylon pour pneus
- Satz 3 Reifenabzieher
- 3 llaves de nylon quita cámaras

Master 96 - Inner 12



8 016038 965459



universale



96000

- Catena bici 116 maglie
- Universal link chain
- Chaîne universelle 116 dents
- Universal Fahrradkette 116 Mesh
- Cadena 116 eslabones universal

Master 96 - Inner 12



8 016038 960003



KIT CHIAVI RIPARAZIONE - CATENA



universale



96555

- Soluzione mastice riparazione forature
- Rubber solution for tube's repairing
- Gomme de reparation de chambre a air
- Gummi-Lösung für Röhre Reparatur
- Masilla para reparar camras de aire

Master 96 - Inner 16

8 016038 965558



96510

- Kit 66 pezzi
- Kit with 66 pieces
- Kit pieces avec 66
- Kit mit 66 Stück
- Kit con 66 piezas

Master 48 - Inner 12

8 016038 965107

**tutto l'occorrente
per la bici**



MASTICE E KIT RIPARAZIONE BICI

contiene:
 2 pezze rotonde
 4 pezze rettangolari
 soluzione mastice
 carta vetrata e gommini

96500

- Set ripara gomme
- Tyres' repair kit
- Kit de reparation pour pneu
- Reifenreparaturset
- Juego repara neumáticos

Master 96 - Inner 16



96560

- Kit riparazione pneumatici
- Bike tyre repair set
- Kit de réparation de pneus de vélo
- Bike Reifen Reparatur-Set
- Reparación de neumáticos de bicicletas conjunto

Master 96 - Inner 12



96565

- Kit completo riparazione bicicletta
- Complete bike repair set
- Réparation de vélos ensemble complet
- Komplettes Fahrrad Reparatur-Set
- Reparación de bicicletas juego completo

Master 48 - Inner 12



KIT RIPARAZIONE BICI



cromato



96020

- Tiraraggi in alluminio cromato
- Chrome spoke rod
- Tire-rays chrome
- Verchromter Speichenschlüssel
- Regulador de radio cromado

Master 96 - Inner 12



8 016038 960201



96550

- 6 pezzi riparazione
- Tube's repair patches
- Rustine pour chambre a air
- Flicken für Schläuchen
- Parches reparación cámaras de aire

Master 96 - Inner 16



8 016038 965503

6 pezzi

resistenti



universale

96295

- Gonfia e ripara pneumatici
- Tube repair spray 100 ml
- Réparation de pneus et de l'inflation
- Reifenreparatur und Inflation
- De reparación de neumáticos y la inflación

Master 72 - Inner 12



8 016038 962953



lubrifica e protegge tutti i tipi di catena
resiste agli agenti atmosferici

96296

- Lubrificante speciale per catene
- Chain Lubrificant 250 ml
- 250 ml lubrifiant de la chaîne
- Kette Schmier 250 ml
- Cadena lubrificante 250 ml

Master 72 - Inner 12



8 016038 962960



TIRARAGGI E PEZZE RIPARAZIONE



sicurezza

security



96750

- Cavo antifurto con chiave
- Cable padlock with key

- Cable cadenas à clé
- Kabel Vorhängeschloss mit Schlüssel
- Cable candado con llave

Master 96 - Inner 12



96752

- Cavo antifurto combinazione
- Cable Padlock with combination

- Cable cadenas à combinaison
- Kabel Vorhängeschloss mit Kombination
- Cable candado con combinación

Master 96 - Inner 12



96754

- Catena antifurto con chiave
- Covered with rubber chain with padlock

- Cable cadenas à clé
- Kabel Vorhängeschloss mit Schlüssel
- Cable candado con llave

Master 96 - Inner 12



96757

- Cavo antifurto con chiave
- Antitheft cable with frame hanger

- Cable cadenas à clé
- Kabel Vorhängeschloss mit Schlüssel
- Cable candado con llave

Master 96 - Inner 12



ANTIFURTI

96760

- Antifurto a cavo temperato
- Antitheft cable with lock and key

- Cable antivol avec fermeture a clef
- Spiralkabelschloss mit Schnellbetätigung
- Cable antirrobo con cerradura de llave

Master 24 - Inner 12



super resistente

struttura super robusta
rivestimento con guaina morbida in pvc
1000 mm

96761

- Antifurto old style
- Cable padlock with key

- Cable cadenas à clé
- Kabel Vorhängeschloss mit Schlüssel
- Cable candado con llave

Master 60 - Inner 12



chiavi in dotazione

super resistente



96762

- Antifurto old style
- Cable padlock with key

- Cable cadenas à clé
- Kabel Vorhängeschloss mit Schlüssel
- Cable candado con llave

Master 60 - Inner 12



chiavi in dotazione

super resistente



96763

- Cavo antifurto master 66
- Chain with padlock

- Chaîne avec cadenas
- Kette mit Zylinderschloss
- Cadena con candado

Master 60 - Inner 12



doppia chiave

guaina morbida





92522

- Pompa d'appoggio con manometro
- Professional bicycle pump with manometer
- Pompe a velo professionnelle avec manometre
- Alupumpe mit Manometer
- Bomba de inflar neumáticos profesional con manometro

Master 10

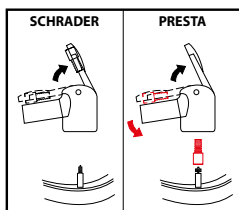

struttura in alluminio
utilizzabile con valvole schrader e presta
base ed impugnatura di ampie dimensioni



96502

- Pompa professionale
- Professional bicycle pump
- Pompe a velo professionnelle
- Alupumpe
- Bomba de inflar neumáticos

Master 10

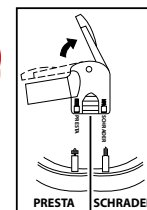

struttura in alluminio
utilizzabile con valvole schrader e presta
base ed impugnatura di ampie dimensioni



96504

- Pompa professionale
- Professional bicycle pump
- Pompe a velo professionnelle
- Alupumpe
- Bomba de inflar neumáticos

Master 10

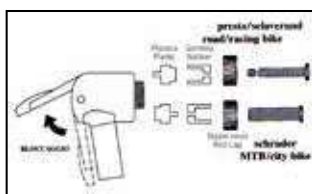

utilizzabile con
valvole schrader
e presta



96512

- Pompa doppio attacco
- Professional bicycle pump
- Pompe a velo professionnelle
- Alupumpe
- Bomba de inflar neumáticos profesional

Master 10

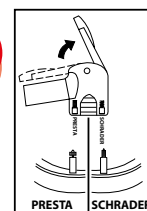

con pratico fermo a piede
utilizzabile con valvole schrader e presta
base ed impugnatura di ampie dimensioni





96505

- Mini pompa con attacchi
- Professional mini pump with hangers

- Pompe a velo
- Luftpumpe
- Bomba de inflar neumáticos

Master 48 - Inner 12



dotata di attacchi
per fissarla alla
bicicletta

dotata di ugello

adattatore per
diverse misure di
valvole

universale per
tutti i tipi di
biciclette



96506

- Pompa gonfia pneumatici
- Bicycle pump

- Pompe a velo
- Luftpumpe
- Bomba de inflar neumáticos

Master 48 - Inner 12



dotata di incastri per
fissarla alla bicicletta



96503

- Pompa in alluminio
- Professional pump

- Pompe a velo
- Luftpumpe
- Bomba de inflar neumáticos

Master 50 - Inner 10



universale per
tutti i tipi di
biciclette



96297

- Kit gonfiaggio professionale
- Kit with 1 regulator + 1 co² cylinder

- Kit de 1 regulateur + 1 bouteille co²
- Set mit 1 Regler + 1 Flasche co²
- Kit de 1 regulador + 1 bombona co²

Master 96 - Inner 12



contiene:
1 regolatore di flusso
1 bomboletta co²

adattabile ad
ogni tipo
di valvola



GONFIAGGIO





96298

- Bomboletta co² professionale
- 1 co² cylinder
- 1 bouteille co²
- 1 Flasche co²
- 1 bombona co²

Master 96 - Inner 12



8 016038 962984

da applicare
apposito
regolatore



96520

- Raccordo pompa universale
- Pump connection
- Raccord de pompe a velo
- Fitting Fahrradpumpe
- Enlace por bomba

Master 96 - Inner 12



8 016038 965206

universale

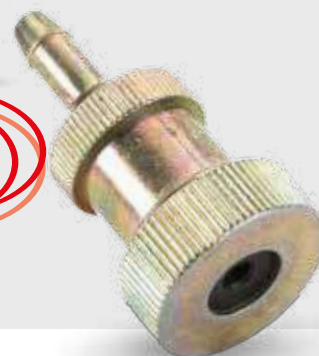

96517

- Raccordo pompa universale
- Pump connection
- Raccord de pompe a velo
- Fitting Fahrradpumpe
- Enlace por bomba

Master 96 - Inner 12



8 016038 965176

universale



96950

- Bretelle omologate di segnalazione
- Reflective safety braces
- Bretelles de signalisation approuvée
- Hosenträger Signalisierung genehmigt
- Los apoyos de señalización aprobada

Master 96 - Inner 12



8 016038 969501

UNISEX
Taglia unica

sport
tempo libero
lavoro



RACCORDO POMPA-BRETELLE





96983-96984-96985-96986

- Paia di guanti traspiranti
- Pair of gloves breathable
- Paire de gants respirant
- Paar Handschuhe atmungsaktiv
- Par de guantes transpirable

Master 60 - Inner 12

- 96983..... TAGLIA S
- 96984..... TAGLIA M
- 96985..... TAGLIA L
- 96986..... TAGLIA XL

8 016038 969839 TAGLIA S

8 016038 969846 TAGLIA M

8 016038 969853 TAGLIA L

8 016038 969860 TAGLIA XL



GONFIA E RIPARA-LUBRIFICANTE-GUANTI



security
sicurezza





96800-96802-96804

- Casco sportivo di sicurezza
- Safety sport helmet

- Casque sportif de securite
- Sportlicher Schutzhelm
- Casco de seguridad para deporte

Master 6

8 016038 968009 TAGLIA S

8 016038 968023 TAGLIA M

8 016038 968047 TAGLIA L



96800..... TAGLIA S52~55cm

96802..... TAGLIA M55~58cm

96804..... TAGLIA L58~61cm

colori assortiti



unisex

omologato
secondo
le ultime
Normative
Europee

cuscinetti riduttori di vari spessori
messi in dotazione
cinghietti morbidi e regolabili
per essere comodi e stabili
maggiore resistenza per la vostra sicurezza

visiera removibile

resistente agli urti

CASCHI





Baby Helmet



96806-96808

- Casco sportivo di sicurezza
- Safety sport helmet

- Casque sportif de securite
- Sportlicher Schutzhelm
- Casco de seguridad para deporte

Master 6



resistente agli urti

omologato
secondo
le ultime



**Normative
Europee**

96806..... TAGLIA S48~52cm

96808..... TAGLIA M52~56cm

colori assortiti



cuscinetti riduttori di vari spessori
messi in dotazione

cinghietti morbidi e regolabili
per essere comodi e stabili

maggior resistenza per la vostra sicurezza



*Fai indossare al tuo bambino
il casco protettivo
conforme alla normativa
tecnica europea
e controlla sempre che sia
regolarmente allacciato!*



CASCHI





gomme**tires**





96579 uomo

- Camera d'aria
- Tube with american valve
- Chambre á air avec valve
- Schlauch mit Ventil
- Cámara de aire con válvula

Master 48 - Inner 12



28X1-5/8X1-3/8

700 x 35C



96580 **Bottari BIKE BIMBOLINE**

- Camera d'aria
- Tube with italy valve
- Chambre á air avec valve
- Schlauch mit Ventil
- Cámara de aire con válvula

Master 48 - Inner 12



16x1.75



96581 BMX

- Camera d'aria
- Tube with italy valve
- Chambre á air avec valve
- Schlauch mit Ventil
- Cámara de aire con válvula

Master 48 - Inner 12



20 x 1.75/95



96594

- Camera d'aria
- Tube with french valve
- Chambre á air avec valve
- Schlauch mit Ventil
- Cámara de aire con válvula

Master 48 - Inner 12



28\"/>

700x23C



CAMERE D'ARIA



96582 - 96584

96586 - 96588

96590

- Camera d'aria
- Tube with italy valve

- Chambre à air avec valve
- Schlauch mit Ventil
- Cámara de aire con válvula

Master 48 - Inner 12



96595 - 96596

96597 - 96598

96599

- Camera d'aria
- Tube with american valve

- Chambre à air avec valve
- Schlauch mit Ventil
- Cámara de aire con válvula

Master 48 - Inner 12

16x1.75-1.95

BAMBINO

Articolo **96595** 8 016038 965954

20x1.50/1.75

RAGAZZO

Articolo **96596** 8 016038 965961

24x1.50/1.75

RAGAZZO

Articolo **96597** 8 016038 965978

26x1.90/1.95
/2.125

MTB

Articolo **96598** 8 016038 965985

26 x 1-3/8

DONNA

Articolo **96599** 8 016038 965992

20x1.50/1.75

RAGAZZO

Articolo **96582** 8 016038 965824

24x1.50/1.75

RAGAZZO

Articolo **96584** 8 016038 965848

26x1-3/8

DONNA

Articolo **96586** 8 016038 965862

28X1-5/8X1-3/8
700X35C

UOMO

Articolo **96588** 8 016038 965886

26x1.50/1.75
1.95/2.125

MTB

Articolo **96590** 8 016038 965909



96577N - 96578N

- Camera d'aria
- Tube with french valve

- Chambre à air avec valve
- Schlauch mit Ventil
- Cámara de aire con válvula

Master 48 - Inner 12



27.5x1.9/2.5

MTB

Articolo **96577N** 8 016038 965770

29x1.9/2.5

MTB

Articolo **96578N** 8 016038 965787

CAMERE D'ARIA





STRADA / STREET

16x1,75

96600

- Pneumatico bicicletta
- Bicycle tires

- Pneus des vélos
- Fahrradreifen
- Neumáticos de bicicletas

Master 10



8 016038 966005



MTB

16x1,75

96602

- Pneumatico bicicletta
- Bicycle tires

- Pneus des vélos
- Fahrradreifen
- Neumáticos de bicicletas

Master 10



8 016038 966029



MTB

20x1,75

96604

- Pneumatico bicicletta
- Bicycle tires

- Pneus des vélos
- Fahrradreifen
- Neumáticos de bicicletas

Master 10



8 016038 966043





STRADA / STREET
20x1,75

96606

- Pneumatico bicicletta
- Bicycle tires

- Pneus des vélos
- Fahrradreifen
- Neumáticos de bicicletas

Master 10



8 016038 966067



MTB
24x1,75

96608

- Pneumatico bicicletta
- Bicycle tires

- Pneus des vélos
- Fahrradreifen
- Neumáticos de bicicletas

Master 10



8 016038 966081



STRADA / STREET
24x1,75

96610

- Pneumatico bicicletta
- Bicycle tires

- Pneus des vélos
- Fahrradreifen
- Neumáticos de bicicletas

Master 10



8 016038 966104



ESEMPIO PACK



PNEUMATICI



STRADA DONNA/ STREET WOMAN

26x1-3/8

96612

- Pneumatico bicicletta
- Bicycle tires

- Pneus des vélos
- Fahrradreifen
- Neumáticos de bicicletas

Master 10



8 016038 966128



MTB

26x2.125

96614

- Pneumatico bicicletta
- Bicycle tires

- Pneus des vélos
- Fahrradreifen
- Neumáticos de bicicletas

Master 10



8 016038 966142



MTB

26x1,90-1,95

96616

- Pneumatico bicicletta
- Bicycle tires

- Pneus des vélos
- Fahrradreifen
- Neumáticos de bicicletas

Master 10



8 016038 966166





MTB SLICK
26x1,75

96618

- Pneumatico bicicletta
- Bicycle tires

- Pneus des vélos
- Fahrradreifen
- Neumáticos de bicicletas

Master 10



8 016038 966180



28x1-5/8-3/8
700 x 35C

96620

- Pneumatico bicicletta
- Bicycle tires

- Pneus des vélos
- Fahrradreifen
- Neumáticos de bicicletas

Master 10



8 016038 966203



CITY BIKE 28'' STRETTO
700x23C

96621

- Pneumatico bicicletta
- Bicycle tires

- Pneus des vélos
- Fahrradreifen
- Neumáticos de bicicletas

Master 10



8 016038 966210



MTB

27,5x2,25

96622

- Pneumatico bicicletta
- Bicycle tires

- Pneus des vélos
- Fahrradreifen
- Neumáticos de bicicletas

Master 10



8 016038 966227

MTB

29x2,125

96623

- Pneumatico bicicletta
- Bicycle tires

- Pneus des vélos
- Fahrradreifen
- Neumáticos de bicicletas

Master 10



8 016038 966234



Bottari
BIKE
BIMBOLINE



attacchi forniti su tutte le ruote

96900-96901

- Ruote stabilizzatrici
- Set of 2 trainer wheels
- Set de 2 roues trainer
- Satz 2 trainer Räder
- Juego de 2 ruedas de entrenador

Master 20 - Inner 10 articolo 96900

Master 20 - Inner 10 articolo 96901



96900

8 016038 969006 articolo 96900 BASIC 1

8 016038 969013 articolo 96901 BASIC 2



96901



96902

- Coppia ruote stabilizzatrici
- Torque stabilizer wheels
- Roues stabilisatrices couple
- Drehmoment Stabilisierungsräder
- Ruedas par estabilizador

Master 20 - Inner 10

8 016038 969020



96896N

1x

- Portabici da terra
in alluminio zincato antiruggine
- Bike stand
- Porte-vélos
- Fahrradseitenständer
- Soporte para bicicletas

MASTER 12

**in alluminio
zincato
antiruggine**

posto
singolo

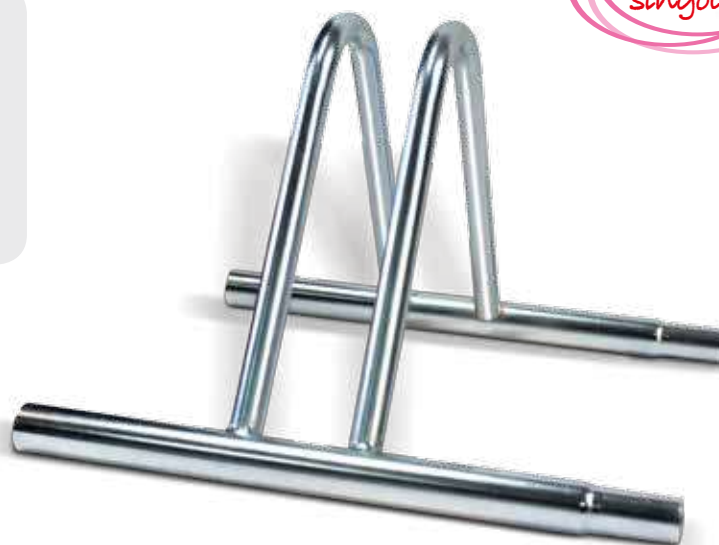

96897N

3x

- Portabici da terra
in alluminio zincato antiruggine
- Bike stand
- Porte-vélos
- Fahrradseitenständer
- Soporte para bicicletas

MASTER 12

3 posti



5 posti

96898N

5x

- Portabici da terra
in alluminio zincato antiruggine
- Bike stand
- Porte-vélos
- Fahrradseitenständer
- Soporte para bicicletas

MASTER 6



DESCRIZIONE

Portabicicletta dal design semplice ideale da posizionare nelle vicinanze di condomini, palestre e uffici. Struttura robusta realizzata interamente in acciaio zincato materiale estremamente resistente ed elegante. La rastrelliera consente di limitare l'ingombro al suolo e di sistemare le bici una accanto all'altra su 2 livelli.

Il portabicicletta a due livelli è disponibile nelle seguenti varianti:

- 1 posto - Dimensioni: L. 390 x P. 380 x h. 250 mm
- 3 posti - Dimensioni: L. 800 x P. 380 x h. 380 mm
- 5 posti - Dimensioni: L. 1400 x P. 380 x h. 380 mm

Caratteristiche tecniche:

Materiale: acciaio zincato

Colore: argento

Bloccaggio di qualsiasi tipo di ruota da 35 a 55 mm

Per un ingombro ridotto

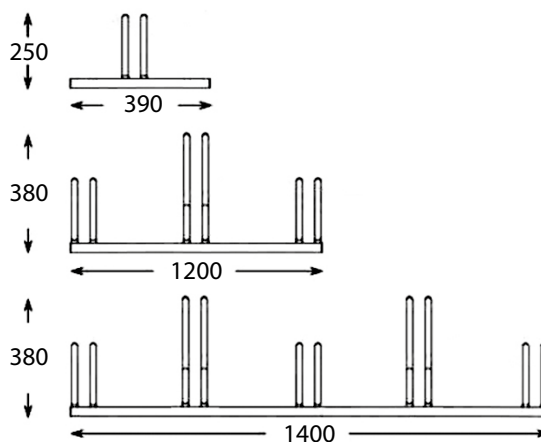



SUPPORTO ALLA VENDITA DISPLAY STANDS

SUPPORTO ALLA VENDITA





SUPPORTO ALLA VENDITA

DISPLAY STANDS

ESPOSITORI IN CARTONE DA TERRA	pag 452
ESPOSITORI DA TERRA	pag 454
ESPOSITORE PER SPAZZOLE	pag 455
ESPOSITORI IN CARTONE DA BANCO	pag 456
ESPOSITORI IN CARTONE A CASSETTI	pag 457
GANCI E CARTELLINO	pag 458
ESPOSITORE 4 PIANI EXPOPLASTIC	pag 459
ESPOSITORE TOTEM	pag 460
ESPOSITORE	pag 461



ESPOSITORI IN CARTONE DA TERRA



ESP.006 ESPOSITORE A 4 VANI PER ACCESSORI AUTO - ASSORTIMENTI VARI



ESP.007 ESPOSITORE X-TRA PER 60 SPAZZOLE



ESP.0011 ESPOSITORE BOTTARI PER 45 SPAZZOLE

ESPOSITORI IN CARTONE DA TERRA



ESP. 16450 VUOTO

ESPOSITORE PER
 PEDANE BAULE VUOTO



Contiene
 10 spazzoloni

ESPO 32238

ESPOSITORE PER ART. 32236-32237
 VIENE FORNITO VUOTO



ESP. 16456

ESPOSITORE VUOTO PEDANE MULTIUSO



ESPOSITORI DA TERRA



ESP.009 ESPOSITORE PER PRODOTTI CHIMICI X-TRA



ESP.30597 ESPOSIT. LAMPADE +30% VISIBILITA' GDO



ESP.30598 ESPOSIT. LAMPADE +50% VISIBILITA' GDO



ESP.77899 ESPOSITORE CHIMICO GOODYEAR ASSORTIMENTI VARI



ESPOSITORE PER SPAZZOLE

ESP. 18535

ESPOSITORE PER SPAZZOLE DA 120 PZ
ALLESTIMENTI VARI



ESPOSITORI IN CARTONE DA BANCO



ESP. 30599 ESP. BANCO X-TRA - 4 COLORI



ESP. 17998 ESPOSITORE BANCO SUPER LIGHT



ESPOSITORI IN CARTONE A CASSETTI



ESP. 14476 ESPOSITORE A SCALETTA BIANCO BOTTARI



ESP. 35901 ESPOSITORE A SCALETTA "SOS"



ESP. 77898 ESPOSITORE A SCALETTA GOODYEAR



ESP. 14475 ESPOSITORE A SCALETTA BOTTARI COL.



MINIBLOCK

13498

- MINIBLOCK ANTIFURTO CON CHIAVE
- MINIBLOCK ANTI THEFT HOOK WITH KEY
- CROCHET MINIBLOCK ANTIVOL AVEC CLEF
- Miniblock haken diebstahlsicherung mit schlüssel
- GANCHO MINIBLOCK ANTIROBO CON LLAVE



MASTER 100 INNER 1



CARTELLINO

0905016

- CARTELLINO FINE GANCIO
- HOOK-END CARD
- PETIT PANNEAU FIN CROCHET
- Schild hakenende
- CARTEL FINO GANCHO



MASTER 100

HOOK

13492 - 13479

- GANCIO PER ESPOSITORE AD "U"
- "U" HOOK FOR DISPLAY STAND
- CROCHET POUR EXPOSANT À "U"
- "U" haken für ausstellung
- GANCHO PARA EXPOSITOR A "U"

13492	cm 20
13479	cm 30



MASTER 100

ESPOSITORE 4 PIANI

EXPOPLASTIC

- ESPOSITORE IN MATERIALE PLASTICO ANTIURTO 4 PIANI
- 4 SHELVES DISPLAY
- EXPOSANT 4 ÉTAGES
- Aussteller 4 Böden
- EXPOSITOR 4 PISOS

DISPONIBILE CON GRAFICHE
AVAILABLE WITH LOGOS
BOTTARI / GOODYEAR

L'ESPOSITORE VIENE FORNITO VUOTO
THE DISPLAY COMES EMPTY



ESEMPIO CON ALLESTIMENTO CHIMICO
EXAMPLE WITH CHEMICALS



ESPOSITORE TOTEM

39990

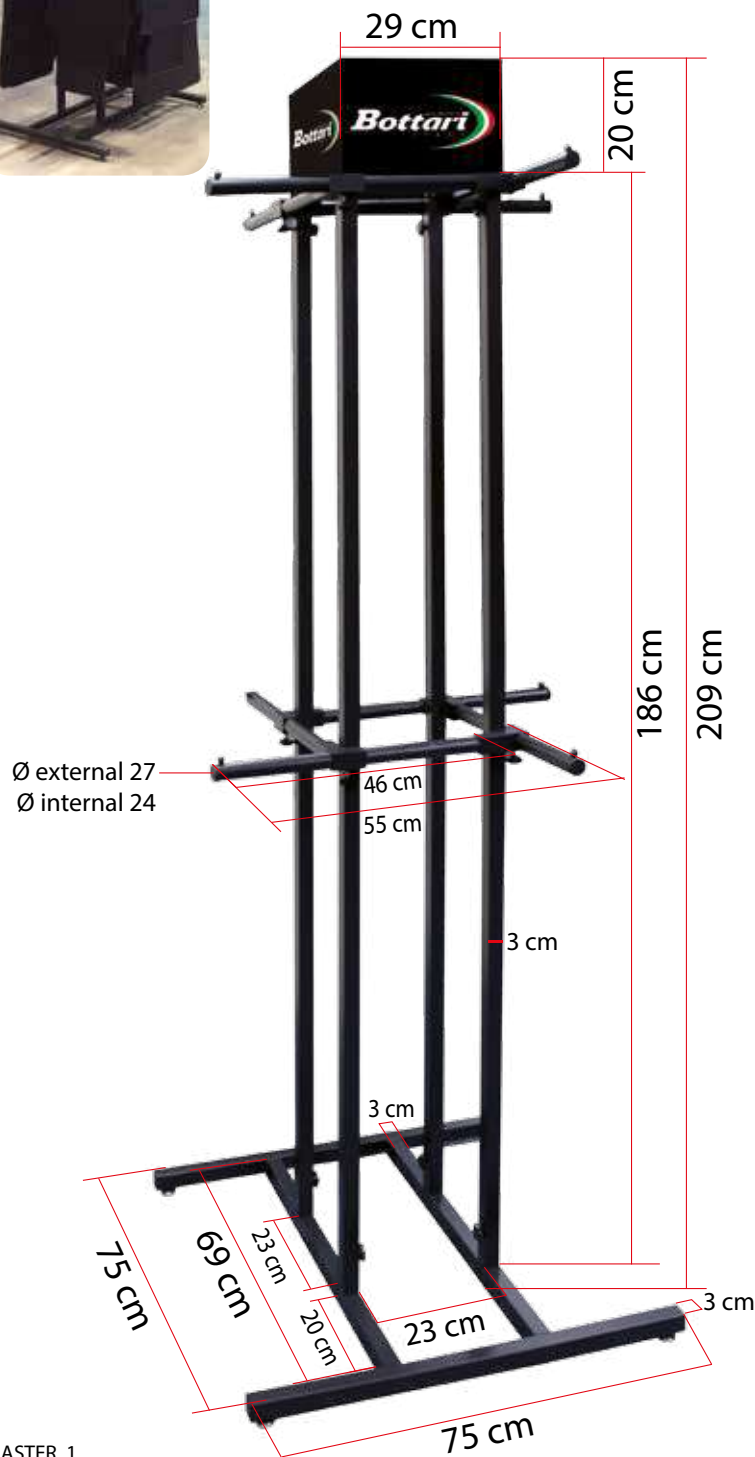

MASTER 1

460

ESPOSITORE

97200GANC21CM

97200GANC25CM

- ESPOSITORE IN MATERIALE PLASTICO ANTIURTO
- DISPLAY

- EXPOSANT
- Aussteller
- EXPOSITOR

DISPONIBILE CON GRAFICHE
AVAILABLE WITH LOGOS
BOTTARI / GOODYEAR

DISPONIBILE CON GANCI DA
AVAILABLE WITH HOOKS FROM
21/25 CM

L'ESPOSITORE VIENE FORNITO VUOTO
THE DISPLAY COMES EMPTY

ESEMPIO CON ALLESTIMENTO DEODORANTI
EXAMPLE WITH PERFUMES



ARTICOLO	DESCRIZIONE PRODOTTO	PAG
006	ESPOSITORE A 4 VANI PER ACCESSORI AUTO	452
007	ESPOSITORE X-TRA PER 60 SPAZZOLE	452
009	ESPOSITORE PER PRODOTTI CHIMICI X-TRA	454
0011	ESPOSITORE BOTTARI PER 45 SPAZZOLE	452
01000	CORDA ELASTICA CM. 40	245
01100	CORDA ELASTICA CM. 40	245
01103	2 SALVA PORTIERE CON CATARIFRANGENTE	242
0905016	CARTELLINO FINE CORSA BOTTARI	458
10023	SET FODERE JACQUARD ELAST.NERO/GRIGIO	199
10024	SET FODERE JACQUARD ELAST.NERO/BLU	199
10027	SET FODERE EMBROIDERY ELAST. NERO/BLU	199
10028	SET FODERA EMBROIDERY ELAST. GRIGIO/NERO	199
10029	SET FODERE EMBROIDERY ELAST. ROSSO/NERO	199
10400	SET COMPLETO FODERE J9 COL.NERO	194
10401	SET COMPLETO FODERE J9 COL.GRIGIO	194
10402	SET COMPLETO FODERE J9 COL.BLU	194
10403	SET FODERE ANTERIORI J2 COL.NERO	200
10404	SET FODERE ANTERIORI J2 COL. GRIGIO	200
10405	SET FODERE ANTERIORI J2 COL.BLU	200
10406	SET COMPLETO FODERE JB9 COL.NERO	194
10407	SET FODERE ANTERIORI JB2 COL.NERO	201
10408	SET COMPLETO FODERE S9 COL.NERO	195
10409	SET COMPLETO FODERE S9 DARK GREY	195
10410	SET FODERE ANTERIORI S2 BLACK	200
10411	SET FODERE ANTERIORI S2 DARK GREY	200
10412	SET COMPLETO FODERE G9 GREY	195
10413	SET FODERE ANTERIORI G2 GREY	201
10414	SET COMPLETO FODERE JB9 COL. BLU	194
10415	SET FODERE ANTERIORI JB2 COL.BLU	201
10416	CAPPUCCIO SINGOLO TRAPUNTATO FANTASIE VARIE	202
10417	CAPPUCCIO SING.TRAPUNT.TINTA UNITA	202
10426BLACK	SUNNY 1 T-SHIRT ANTERIORE COTONE NERO	202
10426BLUE	SUNNY 1 T-SHIRT ANTERIORE COTONE BLU	202
10426DARKGREY	SUNNY 1 T-SHIRT ANTERIORE COTONE GRIGIO SCURO	202
11067D	SPAZZOLA TERGI RAIN TOP MM.330 D/BLISTER	101
11068D	SPAZZOLA TERGI RAIN TOP MM.350 D/BLISTER	101
11069D	SPAZZOLA TERGI RAIN TOP MM.380 D/BLISTER	101
11070D	SPAZZOLA TERGI RAIN TOP MM. 410 D/BLISTER	101
11071D	SPAZZOLA TERGI RAIN TOP MM. 450 D/BLISTER	101
11072D	SPAZZOLA TERGI RAIN TOP MM. 480 D/BLISTER	101
11073D	SPAZZOLA TERGI RAIN TOP MM. 510 D/BLISTER	101
11074D	SPAZZOLA TERGI RAIN TOP MM. 530 D/BLISTER	101
11075D	SPAZZOLA TERGI RAIN TOP MM.550 D/BLISTER	101
11076D	SPAZZOLA TERGI RAIN TOP MM. 600 D/BLISTER	101
11077D	SPAZZOLA TERGI RAIN TOP MM. 650 D/BLISTER	101
11078D	SPAZZOLA TERGI RAIN TOP MM. 700 D/BLISTER	101
11087	SPAZZOLA UNIVERSALE 330 MM IN BLIS.CARD	103
11088	SPAZZOLA UNIVERSALE 350 MM IN BLIS.CARD	103
11089	SPAZZOLA UNIVERSALE 380 MM IN BLIS.CARD	103
11090	SPAZZOLA UNIVERSALE 410 MM IN BLIS.CARD	103
11091	SPAZZOLA UNIVERSALE 450 MM IN BLIS.CARD	103
11092	SPAZZOLA UNIVERSALE 480 MM IN BLIS.CARD	103
11093	SPAZZOLA UNIVERSALE 510 MM IN BLIS.CARD	103
11095	SPAZZOLA UNIVERSALE 550 MM IN BLIS.CARD	103
11096	SPAZZOLA UNIVERSALE 600 MM IN BLIS.CARD	103
11097	SPAZZOLA UNIVERSALE 650 MM IN BLIS.CARD	103
11098	SPAZZOLA UNIVERSALE 700 MM IN BLIS.CARD	103
12072	SCHIENALE "TOP-CLASS" NERO	203
12085	SCHIENALE "MAGNETICO JAVA" BLU	203
12086	SCHIENALE "MAGNETICO JAVA" GRIGIO	203
12087	SCHIENALE "MAGNETICO JAVA" NERO	203

ARTICOLO	DESCRIZIONE PRODOTTO	PAG
12128	SCHIENALE "MALDIVE" NATURALE	208
12150	SCHIENALE BAMBOO WOOD	204
12151	COPPIA SCHIENALI COMBI IMBOTTITI D.FACE	207
12155	SCHIENALE ESTIVO IN FIBRA DI RAFFIA BEIGE	205
12156	SCHIENALE ESTIVO IN FIBRA DI RAFFIA GRIGIO	205
12157	SCHIENALE ESTIVO IN FIBRA DI RAFFIA NERO	205
12158	SCHIENALE POLIESTERE EMBROIDERY RICAMO GRIGIO	204
12198	PROTEGGI SEDILE SINGOLO UNIVERSALE	221
12199	SALVA SEDILE PVC 58X44CM	221
12300	SCHIENALE CARRERA NERO/BLACK	206
12301	SCHIENALE CARRERA GRIGIO/GREY	206
12302	SCHIENALE CALIFORNIA AVORIO	206
12303	SCHIENALE CALIFORNIA NERO	206
12304	SCHIENALE CALIFORNIA GRIGIO	206
12305	COPRISEDILE ESTIVO PAPER, NERO TRASPIRANTE	205
12308	SCHIENALE LINO WAIKIKI NERO	193
12309	SCHIENALE LINO WAIKIKI VIOLA	193
12311	SCHIENALE LINO OHAU MARRONE	192
12312	SCHIENALE LINO OHAU NERO	192
12313	SCHIENALE LINO OHAU GRIGIO	192
12314	SCHIENALE LINO HONOLULU MIX COLOR	192
12315	SCHIENALE LINO MAUI MARRONE-NERO	193
12316	SCHIENALE LINO MAUI GRIGIO-NERO	193
12317	SCHIENALE LINO MAUI NERO GRIGIO	193
13402	POMELLO CAMBIO APACHE GIALLO/NERO	338
13479	GANCIO METALLO DA 30 CM PER ESPOSITORI	458
13492	GANCIO 20 CM AD "U" PER ESPOSITORI	458
13498	MINIBLOCK ANTI-TACCHEGGIO	458
13525	COPRIFRENO A MANO ARGENTO	339
13526	COPRIFRENO A MANO NERO	339
13604	COPRIVOLANTE MESH NERO/ROSSO	337
13605	COPRIVOLANTE MESH NERO/BLU	337
13606	COPRIVOLANTE MESH NERO/GRIGIO	337
13682	ACCENDISIGARI BLU CON LUCI LED	339
13800	COPPIA LUCI ALL NIGHT 12 V.	343
13808	KIT LUCE NEON MINI LIGHT LUCE BLU	343
13809	KIT LUCE NEON MINI LIGHT LUCE VERDE	343
13836	COPPIA LUCI NEON SHINY CM. 23 ROSSO	343
13837	COPPIA LUCI NEON SHINY CM. 23 VIOLA	343
13838	COPPIA LUCI NEON SHINY CM. 23 VERDE	343
13841	COPRIFRENO A MANO ALLUMINIO LED BLU	344
13868	TERMOMETRO LUMINOSO TRIM LED BLU	344
13936	SET 2 LAMPADIE LED COPPIA LUCE LED MAGIC BIANCA T-10	122
13938	CP.LUCI 4 LEDS COL.BLU "CHARM"	122
13939	SET 2 LAMPADIE 4 LED CHARM BIANCO T-10	122
13979	PORTACHIAVE LASER LED SINGOLO BLU	343
14008	CP.TAPPETI ANTERIORI IN GOMMA GOROS LINE	179
14010	SET 4 PZ TAPPETO GHEPARD	183
14023N	SET 4 PZ TAPPETO GOMMA "SCORPION"	182
14029N	SET 4PZ.TAPPETO IN VERA GOMMA "BIG"	181
14035	SET TAPPETI GOMMA UNIV.PERFECT ROSSO	180
14036	SET TAPPETI GOMMA UNIV.PERFECT BLU	180
14037	SET TAPPETI GOMMA UNIV.PERFECT GRIGI	180
14038	SET TAPPETI GOMMA UNIV.PERFECT NERO	180
14041	SET TAPPETI GOMMA UNIV. RADIAL NERI	181
14042N	SET 4 PZ. TAPPETO "BINGO" IN GOMMA	182
14043	SET 4PZ. TAPPETI GOMMA RITAGLIABILI "GOROS LINE"	179
14058	SET 4 PZ TAPPETO GOMMA BROOKLYN NERO	180
14080	SET 4 TAPPETI MOQUETTE UNIV. SOFT NERO	177
14081	SET 4 TAPPETI MOQUETTE UNIV. SOFT GRIGIO	177
14082	SET 4 PZ TAPPETI MOQ.UNIV.EASY NERO	177



ARTICOLO	DESCRIZIONE PRODOTTO	PAG
14099	SET 2 PZ CLIP FERMA TAPPETI 'NO SLIP'	187
14102	TAPPETO "SPECIAL" DOUBLE-FACE SINGOLO	184
14103N	TAPPETINO "GOMMAX" 100% GOMMA	185
14108N	TAPPETO GOMMA "SNOW-MAT"	185
14109	SET 4 PZ.TAPP.LAMINATI CANNA DI FUC.	186
14110	SET 4 PZ.TAPPETO LAMINATO NERO	186
14114	TAPPETINO GRIPPER PVC	184
14115	TAPPETINO GOMMAX NEW 100% GOMMA	184
14118	TAPPETINO GOMMA UNIVERSALE HARLEM	186
14120	SET 4 TAPP. MOQUETTE UNIV.WAVE TRIM NERO	178
14121	SET 4 TAPP. MOQUETTE UNIV.WAVE TRIM GRIGIO	178
14122	SET 4 TAPP. MOQUETTE UNIV.WAVE TRIM BLU	178
14123	SET 4 TAPP. MOQUETTE UNIV.WAVE TRIM ROSSO	178
14124	SET 4 TAPP. MOQUETTE UNIV.WAVE TRIM BEIGE	178
14125	SET 4 TAPP. MOQUETTE UNIV.WAVE TRIM ROSA	178
14395	BATTITACCO "ZERBINOTTO"	185
14398	BATTITACCO ZERBINOTTO COMPACT 39x25 SALVATACCHI	185
14475	ESPOSITORE A SCALETTA BOTTARI COL.	457
14476	ESPOSITORE A SCALETTA BIANCO BOTTARI	457
15007	SONORIZZATORE MARMITTA SOUNDLESS 3	340
15008	TERMINALE MARMITTA ALLUMINIO "PIPE"	340
15009	TERMINALE MARMITTA ALLUMINIO "FURIUS"	340
15012	TERMINALE MARMITTA R.2TT CROMATO	340
15033	TERMINALE MARMITTA POWER X	340
15065	ANTENNA IN ALLUMINIO NERO CM. 9	319
15068	ANTENNA IN ALLUMINIO ARGENTO CM. 9	319
15069	ANTENNA IN ALLUMINIO NERO CM. 16	319
15072	ANTENNA IN ALLUMINIO ARGENTO CM. 16	319
15073	ANTENNA DECORATIVA AIRLINE NERA	341
15099A	SET COPRIVALVOLE "AIR CUP" GRIGIO	164
15099B	SET COPRIVALVOLE "AIR CUP" GRIGIO	164
15100	SET COPRIVALVOLE PNEUMATICI AIR CUP BLU	164
15100A	SET COPRIVALVOLE "AIR CUP" BLU	164
15100B	SET COPRIVALVOLE "AIR CUP" BLU	164
15101	SET COPRIVALVOLE PNEUMATICI AIR CUP ROSSO	164
15101A	SET COPRIVALVOLE "AIR CUP" ROSSE	164
15101B	SET COPRIVALVOLE "AIR CUP" ROSSE	164
15102BLACK	SET COPRIVALVOLE PNEUMATICI AIR CUP CROMATO	164
15102A	SET COPRIVALVOLE "AIR CUP" ARGENTO	164
15102B	SET COPRIVALVOLE "AIR CUP" ARGENTO	164
15102BLACKA	SET COPRIVALVOLE "AIR CUP" NERO	164
15102BLACKB	SET COPRIVALVOLE "AIR CUP" NERO	164
15506	SET 4 PZ. ANTIGRAFFIO R.CHROME CROMATO	243
15510	COPPIA SALVAURTI ADESIVO R.BUMPER NERO	345
15521	SET 4 PZ. SALVAPORTA ADESIVO CROMATO	243
15522	SET 4 PZ. SALVAPORTA ADESIVO CARBON	243
15524	SET 4 PZ. SALVAPORTA ADESIVO GRIGIO	243
15548	PROFILO ADESIVO CROMATO TRIMMING MT. 4	341
15549	PROFILO ADESIVO CROMATO TRIMMING MT. 8	341
16010	COPRIVOLANTE "SPORTING" 37 x 43 CM.	217
16011	COPRIVOLANTE "SPORTING" 33 x 37 CM.	217
16015	COPRIVOLANTE "CHAMPION" PER AUTO	217
16037	AUTONOTES CON PENNA "MEMO"	229
16047	OROLOGIO "CLOCK NEW"	230
16062	TERMOMETRO IN/OUT "JUNIOR"	230
16099	GRIGLIA DI SEPARAZIONE A 3 ELEMENTI	224
16102	GRIGLIA 2 ELEMENTI PER CANI A BARRE	224
16103	RETE DI SEPARAZIONE UNIVERSALE NERA	224
16112	INCLINOMETRO RALLY ILLUMINATO	230
16115	BRACCIOLO PORTA OGGETTI MULTIUSO	220
16118	BRACCIOLO PORTAOGGETTI "MAGIC-BOX"	220

ARTICOLO	DESCRIZIONE PRODOTTO	PAG
16119	BRACCIOLO PORTAOGG. CARBON MAGIC BOX	220
16135	PORTA TELEFONO E PDA EASY	223
16142	POMELLO IN VERA PELLE CLUB	219
16144	POMELLO VOLANTE UNIVERSALE	220
16266	PORTACENERE A BARATTOLO MAGIC	229
16267	PORTACENERE A BARATTOLO CON LED	229
16273	TAPPETINO ANTISCIVOLO PER CRUSCOTTO	228
16283	COPRIVOLANTE IN TPE ORION NERO 37/39 CM	216
16284	COPRIVOLANTE IN TPE ROAD NERO/GRIGIO 37/39 CM	215
16285	COPRIVOLANTE IN TPE ROAD NERO/ROSSO 37/39 CM	215
16286	COPRIVOLANTE IN TPE ROAD NERO/BLU 37/39 CM	215
16287	COPRIVOLANTE IN TPE ORION NERO/GRIGIO 37/39 CM	216
16288	COPRIVOLANTE IN TPE ORION NERO/ROSSO 37/39 CM	216
16289	COPRIVOLANTE IN TPE ORION NERO/BLU 37/39 CM	216
16290	TAPPETINO ANTISCIVOLO "COMODINO"	228
16341	COPRIVOLANTE IN TPE ROAD NERO/GRIGIO SMALL 35/37cm	215
16342	COPRIVOLANTE IN TPE ROAD NERO/ROSSO SMALL 35/37cm	215
16343	COPRIVOLANTE IN TPE ROAD NERO/BLU SMALL 35/37cm	215
16344	COPRIVOLANTE IN TPE ROAD NERO/GRIGIO LARGE 39/41cm	215
16353	PORTA ASSIC.+ DISCO ORARI O D/BLISTER	230
16354	PORTA ASSICURAZIONE CON DISCO ORARIO	230
16360	DISCO ORARO RIGIDO SFUSO	230
16374	RETE PER BAULE MULTIFISSAGGIO	224
16379	FRAME PORTA TELEFONO E NAVIGATORE Small	223
16380	FRAME ULTRA PORTA TELEFONO/ IPAD E NAVIGATORE XL	223
16450	ESPOSITORE 28 PZ. 4 PEDANE MISURE ASS.	226
ESP16450VUOTO	ESPOSITORE PER PEDANE VUOTO	453
16451	PEDANA MULTIUSO MISURA 90 x 50 CM.	226
16452	PEDANA MULTIUSO MISURA 90 x 70 CM.	226
16453	PEDANA MULTIUSO MIS. 90X85CM.	226
16454	PEDANA MULTIUSO MISURA 90 x 100 CM.	226
16455	PEDANA MULTIUSO "RUG PROTECTIVE" 90X120 CM	226
16456	ESPOSITORE VUOTO PEDANE MULTIUSO	453
16461	TAVOLO PORTAOGGETTI REGOLAB. 43X35CM	228
16462	BRACCIOLO MULTIUSO BLACK ARROW	220
16463	BRACCIOLO MULTIUSO CHROME ARROW	220
16741	COPRIVOLANTE IN TPE ERGON RICAMO GRIGIO 37/39 CM	215
16742	COPRIVOLANTE IN TPE ERGON RICAMO ROSSO 37/39 CM	215
16743	COPRIVOLANTE IN TPE ERGON RICAMO BLU 37/39 CM	215
16744	COPRIVOLANTE IN TPE EXAGON 37/39 CM	215
16745	COPRIVOLANTE IN TPE EXAGON 35-37cm SMALL	215
16746	COPRIVOLANTE RODEO DRIVE NERO/GRIGIO 37/39 CM	218
16747	COPRIVOLANTE SUNSET BOULEVARD NERO/GRIGIO 37/39 CM	218
16749	COPRIVOLANTE IN TPE NERO STYLISH SMALL 35-37cm	216
16754	COPRIVOLANTE IN TPE NERO STYLISH 37/39 CM	216
16767	COPRIVOLANTE IN TPE STYLISH PLUS PER FURGONI	216
16768	COPRIVOLANTE IN TPE STYLISHPLUS PER AUTO 39-41cm	216
16781	SEGGIOLINO BAMBINO "TAMBU" NUOVO TIPO	222
16784	SEGGIOLINO BAMBINO TAMBU PREMIUM OMOLOGATO	222
17144	SET 4 PZ.TAPP.LAMIN. RIGHE BLU/CROM.	336
17145	SET 4 PZ.TAPP.LAMIN.RIGHE NERO/CROM.	336
17165	SUPPORTO CERVICALE MY CAT BLU	333
17167	SUPPORTO CERVICALE ROSA MY FLOWER	336
17168	SUPPORTO CERVICALE MY FLOWER BLU	336
17169	SUPPORTO CERVICALE MY DAISY	336
17184	COPRIVOLANTE F104 NERO SMALL 35/37	337
17185	COPRIVOLANTE F104 NERO 37/39 CM	337
17186	COPRIVOLANTE F116 NERO 37/39 CM	217
17187	COPRIVOLANTE F104 NERO LARGE 39/41cm	337
17406	POMELLO CAMBIO CON INSERTO ROSSO	338
17407	POMELLO CAMBIO CON INSERTO ARGENTO	338

ARTICOLO	DESCRIZIONE PRODOTTO	PAG
17430	POMELLO CAMBIO UNIVERSALE "VENERE"	338
17431	POMELLO CAMBIO "SIRIO" NERO/ROSSO	338
17432	POMELLO CAMBIO "SIRIO" NERO/BLU	338
17433	POMELLO CAMBIO "SIRIO" NERO/GRIGIO	338
17434	POMELLO CAMBIO "SIRIO" NERO	338
17500	BANDA ANTISTATICA "X-DEAD"	341
17825	2 LAMPADE SILURO 3 LED BIANCHI "TORPEDO 3"	121
17852	COPPIA LAMPADE CROMATE ENIGMA 12V 5W T10	122
17855	LUCE SUPERLIGHT A LED BIANCHI 12V 12 LEDS	122
17930	KIT MODELLINO AUTO 1:64 HKS S15	345
17931	KIT MODELLINO AUTO 1:64 RX-7 -APEX	345
17998	ESPOSITORE VUOTO BANCO SUPER LIGHT	456
18005	SET 2 PZ. ANTIGRAFFIO BRILL 65 CM. NERO	242
18006	SET 2 PZ. ANTIGRAFFIO BRILL 65 CM. TRASPARENTE	242
18009	COPPIA SALVAPORTA "PAGODA"	242
18050	TAPPO BENZINA EMERGENZA UNIVERSALE	244
18051	TAPPO BENZINA EMERGENZA "NEW CAP FIT"	244
18052	TAPPO BENZINA A VITE SCREW	244
18097	COPRICERCHIO "NEVADA" 13	163
18098	COPRICERCHIO "NEVADA" 14	163
18099	COPRICERCHIO NEVADA P. 15	163
18130	COPRICERCHIO NEVADA P. 16	163
18135	4 PZ. SALVAPORTA "STILEX-CROMO"	242
18142	COPRICERCHIO "DUBAI" Ø 13	163
18143	COPRICERCHIO "DUBAI" Ø 14	163
18144	COPRICERCHIO "DUBAI" Ø 15	163
18164	SR. COPRICERCHI SUZUKA 14"	159
18165	SR. COPRICERCHI SUZUKA 15"	159
18166	SR. COPRICERCHI SUZUKA 14" BLACK	159
18167	SR. COPRICERCHI SUZUKA 15" BLACK	159
18168	SR. COPRICERCHI SUZUKA 14" BICOLOR	159
18169	SR. COPRICERCHI SUZUKA 15" BICOLOR	159
18187	SERIE COPRICER. ABS LOTUS BICOLOR 13	159
18188	SERIE COPRICER. ABS LOTUS BICOLOR 14	159
18200	CINGHIA FISSAGGIO "URSUS" 1X500 CM.	246
18201	CP. CINGHIE FISSAGGIO "URSUS" 2X250 CM.	246
18202	CINGHIA "URSUS" C/CRICCHETTO 1X500 CM.	246
18203	CINGHIA LEGA CARICHI 3000 KG.	246
18205	CINGHIA C/CRIC.+2 GANCI SPECIALI 1X5MT.	246
18207	CINGHIA LEGA CARICHI 2700 KG. - 5 METRI	246
18208	CINGHIA LEGA CARICHI 5000 KG. - 8 METRI	246
18224	CONF. 2 PZ. CORDA ELASTICA CM. 80	245
18225	CONF. 2 PZ. CORDA ELASTICA CM.100	245
18226	CONF. 2 PZ. CORDA ELASTICA CM.150	245
18227	CONF. 2 PZ. CORDA ELASTICA CM. 200	245
18229	RETE X BAGAGLI 72X82 CM	237
18232	PORTABICI DA TETTO TOP ROOF	237
18279	SPECCHIETTO AUSILIARIO "BEST VIEW"	244
18291P/M	COPRIAUTO NYLON ANTISTRAPPO MISURA PICCOLA/MEDIA	78
18294L/XL	COPRIAUTO NYLON ANTISTRAPPO MISURA GRANDE/EXTRA GRANDE	78
18355	COPRIAUTO SUPERGENIUS 'S' IN PVC E TNT	79
18356	COPRIAUTO SUPERGENIUS 'M' IN PVC E TNT	79
18357	COPRIAUTO SUPERGENIUS 'L' IN PVC E TNT	79
18358	COPRIAUTO SUPERGENIUS 'XL' IN PVC E TNT	79
18359	COPRIAUTO SUPERGENIUS 'XXL' IN PVC E TNT	79
18387	BAULE IMPERMEABILE REGOLAB. "ROOMY"	237
18400	COPPIA ADESIVI P PRINCIPIANTE	229
18402	ADESIVO OMOLOGATO VELOCITÀ 70	245
18403	ADESIVO OMOLOGATO VELOCITÀ 80	245
18404	ADESIVO OMOLOGATO VELOCITÀ 100	245
18411	COPRIRUOTA SCORTA ELAST.74X23CM NERO	165

ARTICOLO	DESCRIZIONE PRODOTTO	PAG
18412	COPRIRUOTA SCORTA ELAST.79X28CM NERO	165
18413	COPRIRUOTA SCORTA ELAST.70X23CM NERO	165
18421	SR. COPRICERCHI ALASKA 13`	162
18422	SR. COPRICERCHI ALASKA 14`	162
18423	SR. COPRICERCHI ALASKA 15`	162
18424	SR. COPRICERCHI ALASKA 16`	162
18440	COPRICERCHIO COLORADO P. 16	162
18441	COPRICERCHIO DUBAI P.16	163
18442	COPRICERCHIO CALCUTTA 13`	162
18443	COPRICERCHIO CALCUTTA 14`	162
18444	COPRICERCHIO CALCUTTA 15`	162
18445	COPRICERCHIO ALABAMA 13`	162
18446	COPRICERCHIO ALABAMA 14`	162
18447	COPRICERCHIO ALABAMA 15`	162
18448	COPRICERCHIO ALABAMA 16`	162
18450	SR. COPRICERCHI SILVERSTONE 14"	160
18451	SR. COPRICERCHI SILVERSTONE 15"	160
18452	SR. COPRICERCHI SILVERSTONE 14" BLACK	160
18453	SR. COPRICERCHI SILVERSTONE 15" BLACK	160
18469	COPRICERCHIO "COLORADO" 13	162
18470	COPRICERCHIO "COLORADO" 14	162
18471	COPRICERCHIO "COLORADO" 15	162
18479	SR. COPRICERCHI MENORCA 14"	158
18480	SR.COPRICERCHI MENORCA 15"	158
18481	SR.COPRICERCHI IBIZA 14"	158
18482	SR. COPRICERCHI IBIZA 15"	158
18483	SR.COPRICERCHI VALENCIA 14"	158
18484	SR. COPRICERCHI VALENCIA 15"	158
18491	SR. COPRICERCHI NEW YORK 13`	158
18492	SR. COPRICERCHI NEW YORK 14`	158
18493	SR. COPRICERCHI NEW YORK 15`	158
18510	2 PZ.SPAZZOLE TERGI C/GRAFITE 300MM	102
18511	2 PZ.SPAZZOLE TERGI C/GRAFITE 330MM	102
18512	2 PZ SPAZZOLE TERGI C/GRAFITE 350MM	102
18513	2 PZ.SPAZZOLE TERGI C/GRAFITE 380 MM	102
18514	2 PZ SPAZZOLE TERGI C/GRAFITE 410 MM	102
18515	2 PZ.SPAZZOLE TERGI C/GRAFITE 450 MM	102
18516	2 PZ.SPAZZOLE TERGI C/GRAFITE 480 MM	102
18517	2 PZ.SPAZZOLE TERGI C/GRAFITE 510 MM	102
18518	2 PZ.SPAZZOLE TERGI C/GRAFITE 530 MM	102
18519	2 PZ.SPAZZOLE TERGI C/GRAFITE 550 MM	102
18520	2 PZ.SPAZZOLE TERGI C/GRAFITE 600 MM	102
18521	2 PZ.SPAZZOLA TERGI C/GRAFITE 650 MM	102
18527	2PZ.SPAZZ.TERGI FIAT PUNTO 600+410MM	103
18528	2 PZ.SPAZZOLE TERGI SKODA 530+480MM	103
18529	2 PZ.SPAZZ.TERGI PUNTO 99 550+450MM	103
18530	1 SPAZZOLA TERGI C/GRAFITE 475 MM	103
18531	2 PZ. REFILL C/GRAFITE 610 MM IN PTFE	103
18532	2 PZ REFILL C/GRAFITE 700 MM IN PTFE	103
18535	ESPOSITORE PER SPAZZOLE DA 120 PZ	455
18546	PENNARELLO BIANCO PER PNEUMATICI	165
18547	MISURA PRESSIONE PNEUMATICI "PNEUS"	166
18550	MANOMETRO PROVA PRESSIONE PNEUMATICI	166
18553	KIT MISURA PRES. PNEUMATICI + PISTOLA ARIA	167
18559	PROIETTORI FARI LENTICOLARI BIANCHI	130
18635	SPAZZOLA TERGI C/GRAFITE 300 MM IN D/BLISTER	102
18636	SPAZZOLA TERGI C/GRAFITE 330 MM IN D/BLISTER	102
18637	SPAZZOLA TERGI C/GRAFITE 350 MM IN D/BLISTER	102
18638	SPAZZOLA TERGI C/GRAFITE 380 MM IN D/BLISTER	102
18639	SPAZZOLA TERGI C/GRAFITE 410 MM IN D/BLISTER	102
18640	SPAZZOLA TERGI C/GRAFITE 450 MM IN D/BLISTER	102

ARTICOLO	DESCRIZIONE PRODOTTO	PAG
18641	SPAZZOLA TERGI C/GRAFITE 480 MM IN D/BLISTER	102
18642	SPAZZOLA TERGI C/GRAFITE 510 MM IN D/BLISTER	102
18643	SPAZZOLA TERGI C/GRAFITE 530 MM IN D/BLISTER	102
18644	SPAZZOLA TERGI C/GRAFITE 550 MM IN D/BLISTER	102
18645	SPAZZOLA TERGI C/GRAFITE 600 MM IN D/BLISTER	102
18646	2 PZ. REFILL RICAMBIO 610 MM IN PTFE	102
18648	2 PZ. GOMMINI TERGICRISTALLO 61 CM	101
18678	SERIE COPRICERCHI "MALLORCA" Ø 13	159
18679	SERIE COPRICERCHI "MALLORCA" Ø 14	159
18684	SERIE COPRICERCHI "PORTO" Ø 14	159
18685	SERIE COPRICERCHI "PORTO" Ø 15	159
18686	SERIE COPRICERCHI MALLORCA Ø 15	159
18687	SERIE COPRICERCHI DALLAS Ø 14	158
18688	SERIE COPRICERCHI DALLAS Ø 15	158
18689	SERIE COPRICERCHI DALLAS Ø 16	158
18690	SERIE COPRICERCHI CHICAGO Ø 13	158
18691	SERIE COPRICERCHI CHICAGO Ø 14	158
18692	SERIE COPRICERCHI CHICAGO Ø 15	158
18693	SERIE COPRICERCHI CHICAGO Ø 16	158
18702	ANTENNA TELESCOPICA 4 EL. 57° UNIV.+ KIT TEL 3	317
18708	ANTENNA "TETTO" CM. 60 UNIVERSALE + KIT	317
18709	ANTENNA "TETTO" CM. 40 UNIVERSALE	317
18711	ANTENNA "TETTO" CM. 60 UNIVERSALE	318
18712	ANTENNA "TETTO" CM. 7 UNIVERSALE	318
18713	ANTENNA "TETTO" CM. 14 UNIVERSALE	318
18731	ANTENNA "TETTO" CM. 60 MOD. FIAT/ALFA	318
18732	ANTENNA "TETTO" CM. 36 MOD. FIAT/ALFA	318
18741	ANTENNA PERSONALIZZATA PANDA	317
18744	ANTENNA A TETTO	317
18760	CAVO PROLUNGA ANTENNA CM.450	318
18763	STELO PER ANTENNA AUTO AM/FM 24 CM.	316
18764	STELO PER ANTENNA AUTO AM/FM 20 CM.	316
18765	STELO PER ANTENNA AUTO AM/FM 36,5 CM	316
18766	STELO PER ANTENNA AUTO AM/FM 18 CM.	316
18767	STELO PER ANTENNA AUTO AM/FM 40 CM.	316
18812	CATENA NEVE "RAPID T2" 9MM. MIS 020	144
18813	CATENA NEVE "RAPID T2" 9MM. MIS 030	144
18814	CATENA NEVE "RAPID T2" 9MM. MIS 040	144
18815	CATENA NEVE "RAPID T2" 9MM. MIS 050	144
18816	CATENA NEVE "RAPID T2" 9MM. MIS 060	144
18817	CATENA NEVE "RAPID T2" 9MM. MIS 070	144
18818	CATENA NEVE "RAPID T2" 9MM. MIS 080	144
18819	CATENA NEVE "RAPID T2" 9MM. MIS 090	144
18820	CATENA NEVE "RAPID T2" 9MM. MIS 100	144
18821	CATENE NEVE "RAPID T2" 9MM MIS 045	144
18822	CATENE NEVE "RAPID T2" 9MM MIS 095	144
18823	CATENE NEVE "RAPID T2" 9MM MIS 065	144
18831	CATENE NEVE "RAPID T2" 9MM MIS 110	144
18832	CATENE NEVE "RAPID T2" 9MM MIS 120	144
18833	CATENE NEVE "RAPID T2" 9MM MIS 130	144
18834N	SET CAT.NEVE RAPID T2ROMBO-9MM M.075	144
18835N	SET CAT.NEVE RAPID T2ROMBO-9MM M.140	144
18848	SPAZZOLA TERGI FLAT 11 ELEM. BOTTARI 330	98
18849	SPAZZOLA TERGI FLAT 11 ELEM. BOTTARI 350	98
18850	SPAZZOLA TERGI FLAT 11 ELEM. BOTTARI 380	98
18851	SPAZZOLA TERGI FLAT 11 ELEM. BOTTARI 410	98
18852	SPAZZOLA TERGI FLAT 11 ELEM. BOTTARI 450	98
18853	SPAZZOLA TERGI FLAT 11 ELEM. BOTTARI 480	98
18854	SPAZZOLA TERGI FLAT 11 ELEM. BOTTARI 510	98
18855	SPAZZOLA TERGI FLAT 11 ELEM. BOTTARI 530	98
18856	SPAZZOLA TERGI FLAT 11 ELEM. BOTTARI 550	98

ARTICOLO	DESCRIZIONE PRODOTTO	PAG
18857	SPAZZOLA TERGI FLAT 11 ELEM. BOTTARI 600	98
18858	SPAZZOLA TERGI FLAT 11 ELEM. BOTTARI 650	98
18859	SPAZZOLA TERGI FLAT 11 ELEM. BOTTARI 700	98
18890	SPAZZOLE TERGI FLAT POSTERIORE BOTTARI 275	100
18891	SPAZZOLE TERGI FLAT POSTERIORE BOTTARI 300	100
18892	SPAZZOLE TERGI FLAT POSTERIORE BOTTARI 325	100
18893	SPAZZOLE TERGI FLAT POSTERIORE BOTTARI 350	100
18894	SPAZZOLE TERGI FLAT POSTERIORE BOTTARI 375	100
18895	SPAZZOLE TERGI FLAT POSTERIORE BOTTARI 400	100
19011N	SPAZZOLA TERGI C/GRAFITE 330 MM IN BOX	99
19012N	SPAZZOLA TERGI C/GRAFITE 350 MM IN BOX	99
19013N	SPAZZOLA TERGI C/GRAFITE 380 MM IN BOX	99
19014N	SPAZZOLA TERGI C/GRAFITE 410 MM IN BOX	99
19015N	SPAZZOLA TERGI C/GRAFITE 450 MM IN BOX	99
19016N	SPAZZOLA TERGI C/GRAFITE 480 MM IN BOX	99
19017N	SPAZZOLA TERGI C/GRAFITE 510 MM IN BOX	99
19018N	SPAZZOLA TERGI C/GRAFITE 530 MM IN BOX	99
19019N	SPAZZOLA TERGI C/GRAFITE 550 MM IN BOX	99
19020N	SPAZZOLA TERGI C/GRAFITE 600 MM IN BOX	99
19021N	SPAZZOLA TERGI C/GRAFITE 650 MM IN BOX	99
20992	BRACCIALE ALLONTANA ZANZARE	274
21300	DEOD. SCENTED MINI BOTTLE APPLE/MELA	268
21301	DEOD. SCENTED MINI BOTTLE BREEZE	268
21302	DEOD. SCENTED MINI BOTTLE LEMON	268
21303	DEOD. SCENTED MINI BOTTLE VANILLA	268
21304	DEOD. SCENTED MINI BOTTLE STRAWBERRY	268
21305	DEOD. SCENTED MINI BOTTLE TROPICAL FRUITS	268
21306	DEOD. SCENTED MINI BOTTLE CHERRY	268
21308	BARATTOLO DEOD. SCENTED MINI BOTTLE MIX 44 PZ.	268
21310	DEOD. TULIP CLASSIC GREEN APPLE	269
21311	DEOD. TULIP CLASSIC LEMON	269
21312	DEOD. TULIP CLASSIC SPORT	269
21313	DEOD. TULIP CLASSIC VANILLA	269
21320	DEOD. INTENSE APPLE	269
21321	DEOD. INTENSE ORANGE & TEA	269
21322	DEOD. INTENSE NEW CAR	269
21323	DEOD. INTENSE BLACK ICE	269
21324	DEOD. INTENSE STRAWBERRY	269
21325	DEOD. INTENSE VANILLA	269
21330	DEOD. AIR PERFUME APPLE	269
21331	DEOD. AIR PERFUME BLACK	269
21332	DEOD. AIR PERFUME BREEZE	269
21333	DEOD. AIR PERFUME LEMON	269
21334	DEOD. AIR PERFUME PINE	269
21335	DEOD. AIR PERFUME VANILLA	269
21340	DEOD. JELLO APPLE	268
21341	DEOD. JELLO BREEZE	268
21342	DEOD. JELLO LEMON	268
21343	DEOD. JELLO PINE	268
21344	DEOD. JELLO TROPICAL FRUITS	268
21345	DEOD. JELLO VANILLA	268
21400	DEOD. MON LUX LEATHER.	270
21401	DEOD. MON LUX VANILLA CHOCO	270
21402	DEOD. MON LUX ELEGANCE	270
21403	DEOD. MON LUX BEVERLY HILLS	270
21404	DEOD. MON LUX MIAMI BEACH	270
21405	DEOD. MON LUX YACHTING	270
21406	DEOD. MON LUX COCONUT	270
21407	DEOD. MON LUX MOJITO	270
21408	DEOD. MON LUX MELON	270
21409	DEOD. MON LUX PARTY	270

ARTICOLO	DESCRIZIONE PRODOTTO	PAG
21410	DEOD. MON LUX MOUNTAIN FRESH	270
21411	DEOD. MON LUX SUMMER DREAM.	270
21412	DEOD. MON LUX LILAC	270
21413	DEOD. MON LUX BUBBLE GUM	270
21414	DEOD. MON LUX TORTUGA	270
21415	DEOD. MON LUX BLACK CRYSTAL	270
21416	DEOD. MON LUX VANILLA BUBBLE	270
21417	DEOD. MON LUX VANILLA MIA	270
21430	DEOD. DRY SMILE VANILLA	270
21431	DEOD. DRY SMILE BUBBLE GUM	270
21432	DEOD. DRY SMILE NO SMOKING	270
21433	DEOD. DRY SMILE TUTTI FRUTTI	270
21434	DEOD. DRY SMILE FRESH AIR	270
21435	DEOD. DRY SMILE PARTY	270
21450	DEOD. MON CLASSIC PERFUME	271
21451	DEOD. MON CLASSIC GREEN APPLE	271
21452	DEOD. MON CLASSIC OCEAN	271
21453	DEOD. MON CLASSIC NEW CAR	271
21454	DEOD. MON CLASSIC LEMON	271
21455	DEOD. MON CLASSIC TUTTI FRUTTI	271
21456	DEOD. MON CLASSIC VANILLA	271
21457	DEOD. MON CLASSIC PINE	271
21458	DEOD. MON CLASSIC STRAWBERRY	271
21459	DEOD. MON CLASSIC PEACH	271
21470	DEOD. X VERSION PARTY	270
21471	DEOD. X VERSION VANILLA	270
21472	DEOD. X VERSION BUBBLE GUM	270
21480	DEOD. SPORT LUX GOLD	271
21481	DEOD. SPORT LUX SILVER	271
21482	DEOD. SPORT LUX PLATINUM	271
21483	DEOD. SPORT LUX CARBON	271
21484	DEOD. SPORT LUX CHROME	271
21485	DEOD. SPORT LUX NICKEL	271
21807	PARASOLE RIFLETTENTE CARB 60X145 CM	312
21842	AVVOLGICINTURE NEMO	313
21894	PARASOLE RIFLETTENTE WINNIE 60X145CM	312
21950	CUSCINO COLLO "PRINCESS"	313
21951	AVVOLGICINTURE "PRINCESS" BIANCANEVE	313
21954	PROTETTORE SEDILE "PRINCESS"	221
22040	CP.TEND.LAT.CM.40X45 + 6 VENTOSE+VELCRO	309
22041	CP.TEND.LAT.CM.45X55 + 6 VENTOSE+VELCRO	309
22051	COPPIA TENDINE LATERALI "SPRINT"	309
22052	TENDINA PARASOLE "FAST" ANTER/POSTER.	309
22135	PARASOLE DOUBLEFACE "PROTEX" 60X130 CM	310
22136	PARASOLE RIFLETTENTE "POLAR" 60X130 CM	310
22142	PARASOLE "PROTEX PLUS" 80X150 CM	310
22143	PARASOLE DOPPIO STRATO ALLUMINIO 90X150	310
22161	PARASOLE POLAR PREMIUM 145x70cm COLORI OPACHI	311
22163	PARASOLE PROTEX PREMIUM 130x60cm COLORI OPACHI	311
22165	PARASOLE SPECCHIATO HOLOGRAM 135x60cm	308
22166	PARASOLE SPECCHIATO HOLOGRAM 145x70cm	308
24013	KIT CHIAVI 30 PEZZI TOP 2	280
24029	SET MULTIUSO 25 IN 1	280
24038	KIT 10 FASCETTE MULTIUSO ACCIAIO ASS.	283
24041	IMBUTO FLESSIBILE	283
24042	SET 4 IMBUTI MISURE ASSORTITE	283
24050	COMPRESSORE "STRONG" 17 ATM.	278
24051	"REVOLVING" LAMPEGGIATORE	291
24054	COMPRESSORE CON MANOMETRO 12V	278
24055	POMPA GONFIATUTTO A 1 CILINDRO	281
24056	POMPA GONFIATUTTO A 2 CILINDRI	281

ARTICOLO	DESCRIZIONE PRODOTTO	PAG
24061	COMPRESSORE AIR-TIRE 12V 140PSI	278
24065	XS LINE RIPARA E SIGILLA GOMME	279
24066	500 ml XS LINE RICARICA	279
24113	MORSETTO STACCA BATTERIA STUCK	303
24117	COPPIA MORSETTI BATTERIA STAR	303
24118	COPPIA MORSETTI BATTERIA DE LUXE	303
24119	COPPIA MORSETTI BATTERIA ALFA	303
24129	CHIAVE FILTRO OLIO A NASTRO "JUNIOR"	283
24135	CHIAVE FILTRO OLIO A CATENA "JUNIOR"	283
24138	CHIAVE CANDELA CORTA 16 MM. SHORT	280
24139	CHIAVE CANDELA CORTA 21 MM. SHORT	280
24141	TESTER ANTIGELO CILINDRICO	283
24143	DENSIMETRO PER BATTERIA	283
24146	CHIAVE CANDELA FIRE LUSO 16MM. SUPER	280
24147	CHIAVE CANDELA LUSO 21 MM. SUPER	280
24150	CAVARUOTE "MASTER" 17/19	165
24153	CAVARUOTE MASTER 17/19 - 21/23	165
24161	CHIAVE A CROCE ARGENTATA SILVER	165
24200	PAIO GUANTI LAVORO NYLON-NITRILE G1 MISURA UNIVERSALE	320
24203	PAIO GUANTI LAVORO JERSEY-NITRILE G4 MISURA UNIVERSALE	320
24208	PAIO GUANTI LAVORO NYLON-PVC G9 MISURA UNIVERSALE	320
26002	ASTA ANTIFURTO "AUTOBLOCK" C/CHIAVE	316
27515A	SET COPRIVALV.PNEUM.TIRE CUP CROMATE	164
27515B	SET COPRIVALV.PNEUM.TIRE CUP CROMATE	164
27516	SET COPRIVALVOLE PNEUMATICI "TIRE CUP" BLU	164
27516A	SET COPRIVALVOLE PNEUM.TIRE CUP BLU	164
27516B	SET COPRIVALVOLE PNEUM.TIRE CUP BLU	164
27517A	SET COPRIVALV.PNEUM.TIRE CUP ROSSE	164
27517B	SET COPRIVALV.PNEUM.TIRE CUP ROSSE	164
27518	SET COPRIVALVOLE PNEUMATICI "TIRE CUP" NERO	164
27518A	SET COPRIVALVOLE PNEUMATICI "TIRE CUP" NERO	164
27518B	SET COPRIVALVOLE PNEUMATICI "TIRE CUP" NERO	164
27519A	SET COPRIVALVOLE PNEUMATICI "TIRE CUP" GRIGIO	164
27519B	SET COPRIVALVOLE PNEUMATICI "TIRE CUP" GRIGIO	164
28001	CORDA TRAINOCAR 2800 KG.	299
28004	CORDA TRAINOCAR 2100 KG.	299
28005	CORDA TRAINOCAR 2100 KG. IN DOPPIO BLISTER	299
28009	CORDA TRAINO IN ACCIAIO 5000 KG.	299
28016	BARRA TRAINO IN METALLO 2000 KG.	299
28020	CAVI BATTERIA PROFESS. 200 A.	296
28021	CAVI BATTERIA PROFESS. 200 A. BLISTER	296
28022	CAVI BATTERIA PROFESS. 400 A.	296
28024	CAVI BATTERIA PROFESS. Ø 16 400 A.	297
28026	CAVI BATTERIA PROFESS. Ø 25 500 A.	297
28031	SIGILLANTE Istantaneo "SUPER RAPID"	304
28034	CASSETTA PRONTO SOCCORSO	302
28037	TROUSSES LAMPADE ALOGENA H1	125
28038	TROUSSES LAMPADE ALOGENA H1 + H7	125
28039	KIT PRONTO SOCCORSO DIN 13164	302
28042	ETILOMETRO A LUCE LED E PORTACHIAVI "DRIVE SAFE"	302
28045	TROUSSES LAMPADE ALOGENE H4	125
28046	TROUSSES LAMPADE ALOGENE H7	125
28050	CARTELLO CARICO SPORGENTE 4 GEMME	300
28055	TANICA 8 LITRI "JOLLY TANK" SFUSA	300
28056	TANICA 8 LITRI "JOLLY TANK" CONFEZIONATA	300
28057	TANICA METALLO 20 LT. OMOLOGATA	301
28058	TANICA METALLO 10 LT. OMOLOGATA	301
28059	TANICA METALLO 5 LT. OMOLOGATA	301
28061	TANICA PLASTICA 5 LT.	301
28062	TANICA PLASTICA 10 LT.	301
28067	TANICA PLASTICA 20 LT.	301

ARTICOLO	DESCRIZIONE PRODOTTO	PAG
28069	POMPA ASPIRA LIQUIDI "SIPHON PUMP"	283
28076	SET 2 PCS SIGILLANTE ISTANTANEO	304
28077	SET 3 PCS SIGILLANTE ISTANTANEO	304
28080	VENTOSA RIPARA CARROZZERIA	300
28086	ESTINTORE 1 KG C/MANOMETRO	301
28106	CARICA BATTERIA 6 AMP. 12V 230V "ENERGY"	303
28107	CARICA BATTERIA IN METALLO 6 AMP.	285
29010	SET FODERA MY FLOWER SWIVEL PINK	328
29011	SET FODERA MY FLOWER SWIVEL BLUE	328
29012	SET FODERA MY FLOWER SWIVEL GREEN/VIOLET	328
29013	SET FODERA MY STAR PINK	326
29014	SET FODERA MY STAR BLUE	326
29015	SET FODERA MY STAR GREEN/VIOLET	326
29016	SET FODERA MY SPRING FLOWERS PINK	324
29017	SET FODERA MY SPRING FLOWERS BLUE	324
29018	SET FODERA MY SPRING FLOWERS RED/GREEN	324
29019	SET FODERA MY SWEET CAT WHITE	330
29020	SET FODERA MY SWEET CAT PINK	330
29022	SET FODERA MY SWEET KITTY PINK	332
29024	SET FODERA MY SWEET KITTY GREEN	332
29041	SALVAPORTA 12PZ CRYSTAL CROMATO	334
29042	SALVAPORTA 12PZ CRYSTAL NERO	334
29055	COPRISEDILE MY PURPLE DOUBLE FANTASY	333
29056	COPRISEDILE MY BLACK DOUBLE FANTASY	333
29057	COPRISEDILE MY FLOWER SWIVEL PINK	328
29058	COPRISEDILE MY FLOWER SWIVEL BLUE	328
29059	COPRISEDILE MY FLOWER SWIVEL GREEN/VIOLET	328
29060	COPRISEDILE MY STAR PINK	326
29061	COPRISEDILE MY STAR BLUE	326
29062	COPRISEDILE MY STAR GREEN/VIOLET	326
29063	COPRISEDILE MY SPRING FLOWERS PINK	324
29064	COPRISEDILE MY SPRING FLOWERS BLUE	324
29065	COPRISEDILE MY SPRING FLOWERS GREEN/RED	324
29066	COPRISEDILE MY SWEET CAT WHITE	330
29067	COPRISEDILE MY SWEET CAT PINK	330
29108	SET 4 PZ TAPPETI LAMINATI ROSA	333
29109	SET TAPPETI MOQUETTE MY FLOWER PINK	329
29110	SET TAPPETI MOQUETTE MY FLOWER BLUE	329
29111	SET TAPPETI MOQUETTE MY FLOWER GREEN/VIOLET	329
29112	SET TAPPETI MOQUETTE MY STAR PINK	327
29113	SET TAPPETI IN MOQUETTE MY STAR BLUE	327
29114	SET TAPPETI IN MOQUETTE MY STAR GREEN/VIOLET	327
29115	SET TAPPETI MOQUETTE MY SPRING FLOWERS PINK	325
29116	SET TAPPETI MOQUETTE MY SPRING FLOWERS BLUE	325
29117	SET TAPPETI MOQUETTE MY SPRING FLOWERS GREEN/VIOLET	325
29118	SET TAPPETI MOQUETTE MY SWEET CAT WHITE	331
29119	SET TAPPETI MOQUETTE MY SWEET CAT PINK	331
29121	SET TAPPETI MOQUETTE MY SWEET KITTY PINK	332
29157	CP.AVVOLGICINTURE MY FLOWER SWIVEL PINK	329
29158	CP.AVVOLGICINTURE MY FLOWER SWIVEL BLUE	329
29160	CP.AVVOLGICINTURE MY STAR PINK	327
29161	CP.AVVOLGICINTURE MY STAR BLUE	327
29163	CP.AVVOLGICINTURE MY SPRING FLOWERS PINK	325
29164	CP.AVVOLGICINTURE MY SPRING FLOWERS BLUE	325
29166	CP.AVVOLGICINTURE MY SWEET CAT WHITE	331
29167	CP.AVVOLGICINTURE MY SWEET CAT PINK	331
29207	COPRIVOLANTE MY FLOWER SWIVEL PINK	329
29210	COPRIVOLANTE MY STAR PINK	327
29211	COPRIVOLANTE MY STAR BLUE	327
29213	COPRIVOLANTE MY SPRING FLOWERS PINK	325
29214	COPRIVOLANTE MY SPRING FLOWERS BLUE	325

ARTICOLO	DESCRIZIONE PRODOTTO	PAG
29216	COPRIVOLANTE MY SWEET CAT WHITE	331
29217	COPRIVOLANTE MY SWEET CAT PINK	331
29301	PARASOLE ALLUMINIO E MICROFORATO 80X150 PINK MESH	312
29401	PELUCHE DECORATIVO MY HEART	335
29405	COLLANA DECORATIVA HAWAII VIOLA	334
29406	COLLANA DECORATIVA HAWAII GIALLO	334
29407	COLLANA DECORATIVA HAWAII ROSA	334
29408	COLLANA DECORATIVA HAWAII BLU	334
29501	DEODORANTE PELOUCHE MY PUPPY	272
30020	LAMPADA A NEON 5 MT. CAVO	291
30024	LAMPADA AL NEON 220 V.8W 5 MT.CAVO	291
30032	LANTERNA CAMPING 17 LED	291
30036	LAMPADA RICARICABILE 60 LED 12V 220V	291
30044	VENTILATORE "OSCILLANTE" 12 V.	290
30066	ASPIRAPOLVERE 12V-80W MAXI CLEANER	78
30067	ASPIRAPOLVERE 12V-60W MIDI CLEANER	77
30071	QUADRUPLA PRESA ACCENDISIGARI 12V	289
30072	TRIPLA PRESA ACCENDISIGARI 12V	289
30074	ADATTATORE A 12V PER AUTO "ADAPTER"	287
30076	DOPIA PRESA MULTIUSO 12V "DUAL"	289
30077	DOPIA PRESA MULTIUSO 12V "TWO SOCKETS"	289
30085	KIT ACCENDINO ILLUMINATO MOD. EUROPA	290
30087	ACCENDINO MOD. EUROPA	290
30093	KIT ACCENDINO ILLUMINATO	290
30094	TESTER BATTERIA PROFESSIONAL	300
30096	ACCENDISIGARI	290
30110	CARTELLA 10 FUSIBILI CILINDRICI	292
30112	CARTELLA 10 FUSIBILI BILAMA	292
30113	CARTELLA 10 MINI-FUSIBILI BILAMA	292
30121	SET 10 PZ. FUSIBILI BILAMA C/TESTER "SAFE"	292
30125X	LAMPADA 12 V. H7 55W PX22D	126
30127	LAMPADA H7 12V 55W IN BLISTER	123
30128	LAMPADA A LOGENA 12V H3 55W IN D/B	123
30129	LAMPADA 12 V H1 BLISTER	123
30130X	LAMPADA 12 V. H1 55W P 14,5 S	126
30131X	LAMPADA 12 V. H1 70W P 14,5 S	126
30132X	LAMPADA 12 V. H3 55W PK22S	126
30134X	LAMPADA 12 V. H4 60/55W P43T	126
30135	LAMPADA 12 V. H4 60/55W P 43 T BLISTER	123
30136X	LAMPADA 24 V.H4 70/75 W. P43T	126
30137X	LAMPADA 12 V. H4 100/80 W P43T	126
30138	LAMPADA 12 V. H5 60/55W P45T	126
30139	LAMPADA 12 V. H5 60/55W P 45 T BLISTER	123
30142X	LAMPADA 12V. 45/40W ASIMMETRICA	127
30143	LAMPADA ASIMMETRICA 12 V. 45/40W BLISTER	123
30144X	LAMPADA 12V. 21W BA15S	127
30145	2 PZ LAMP.12V. 21W BA15S BLIS.05103	124
30146X	LAMPADA 24V. 21W BA15S	127
30147X	LAMPADA 24V 1.2W	128
30148X	LAMPADA 12V. 5/21W BAY15D	128
30149	2PZ LAMP.12V 5/21W BAY15D BLIS.	124
30150X	LAMPADA 24V. 5/21W BAY15D	128
30151X	LAMPADA 12V. 10W BA15S	127
30152X	LAMPADA 12V. 5W BA15S	127
30153	2 PZ LAMP.12V 5W BA15S BLIS.	124
30154X	LAMPADA 24V. 5W BA15S	127
30156X	LAMPADA 12V. 5W T10 TUTTO VETRO	128
30157	CONF. 2 PZ. LAMPADE 12V 5W T10 VETRO BL.	124
30158	LAMPADA 12V. 3W T10 TUTTO VETRO	125
30159	CONF.2 PZ. LAMPADE 12V 3W T10 VETRO BL.	124
30160X	LAMPADA 12V. 4W BA9S	128

ARTICOLO	DESCRIZIONE PRODOTTO	PAG
30161X	LAMPADA 24V 5W T10 ALL GLASS	128
30162	LAMPADA 12 V. 3W BA 9 S	128
30163	CONF. 2 PZ. LAMPADE 12 V. 5W 10,5X38 BLISTER	124
30164X	LAMPADA 12V. 1,2W T5 TUTTO VETRO	128
30165X	LAMPADA 12V. 10W 10,5X38	128
30166X	LAMPADA 12V. 5W SILURO	128
30168X	LAMPADA 24V. H1 70W P14,5S	126
30169X	LAMPADA 24V. H3 70W PK22S	126
30173X	LAMPADA 24V 2W BA9S	128
30174X	LAMPADA 24V. 5W 10,5X38	128
30187X	LAMPADA 24 V. 10W 10,5X38	128
30189X	LAMPADA 24 V. 4W BA9S	128
30190X	LAMPADA H7 24V 70W	126
30192X	LAMPADA 12V 2W BA9S	128
30204	PORTA USB AUTO CHARGER 12V-24V	287
30206	PRESA 12V SOCKET	290
30242	CARICA BATTERIA CELLULARE IPHONE 4 - 5 - 6 - 6plus	286
30243	MULTI CARICATORE CASA-AUTO	286
30244	MINI CARICATORE PER AUTO	286
30270	KIT SENSORE DI PARCHEGGIO 12V	292
30275	KIT TROMBA + BOMBOLA	289
30500	SET 2 PZ. LAMPADE "XENON RAINBOW" BLU 12V H1 55W	119
30502	SET 2PZ LAMP.XENON RAINBOW BLU 12VH3 55W	119
30504	SET 2 PZ. LAMPADE "XENON RAINBOW" BLU 12V H4 60/ 55W	119
30508	SET 2 PZ. LAMPADE "XENON RAINBOW" BLU 12V H7 55W	119
30510	SET 2 PZ. LAMPADE "SUPER WHITE" 12V H1 55W	119
30511	SET 2 PZ. LAMPADE "SUPER WHITE" 12V H1 130W	119
30512	SET 2 PZ. LAMPADE "SUPER WHITE" 12V H3 55W	119
30514	SET 2 PZ. LAMPADE "SUPER WHITE" 12V H4 60/ 55W	119
30516	2PZ LAMP.SUPER WHITE 12V H5 60/55W	119
30518	SET 2 PZ. LAMPADE "SUPER WHITE" 12V H7 55W	119
30562	LAMPADA 12V H1 +30% LUMINOSITA'	121
30563	LAMPADA 12V H4 +30% LUMINOSITA'	121
30564	LAMPADA 12V H5 +30% LUMINOSITA'	121
30565	LAMPADA 12V H7 +30% LUMINOSITA'	121
30578	SET 2 PZ LAMP:12V 5W 10.5X44 VETRO BLU - LED BIANCO	120
30580	LAMPADA 12V H1 55W +50% LUMINOSITA'	120
30582	LAMP.12V H4 60/55W +50% LUMINOSITA'	120
30584	LAMPADA 12V H7 55W +50% LUMINOSITA'	120
30586	LAMPADA 12V H5 60/55W BLISTER	120
30597	ESPOSIT.LAMPADE +30% VISIBILITA' GDO	454
30598	ESPOSIT.LAMPADE +50% VISIBILITA' GDO	454
30599	ESP.BANCO X-TRA - 4 COLORI	456
30669	OLIO ESTRATT.ELETTRICO 12 V.OIL EASY	281
30790	VIDEO & TARGA KIT PORTATARGA	244
31268	RAVVIVANTE PER GOMME DA 1 LT	61
31269	LUCIDA GOMME SCHIUMA 650 ML	61
31271	NERO GOMME 250 ml SCHIUMA	61
31350	LIQUIDO VASCHETTA VETRI 250 ML	66
31357	BOTTARI LIQUIDO VASCHETTA VETRI 5 LT	66
31371	LIQUIDO RADIATORE ROSSO -22° 1 L.	64
31372	LIQUIDO RADIATORE BLU -22° 1 L.	64
31373	LIQUIDO RADIATORE ROSSO -22° 5 L.	64
31374	LIQUIDO RADIATORE BLU -22° 5 L.	64
31376	LIQUIDO FRENI DOT 4 250 ML	63
31380	GONFIA E RIPARA GOMME 450 ML	62
31384	SBLOCCANTE LUBRIFICANTE SPRAY 250 ML	62
31385	SBLOCCANTE LUBRIFICANTE SPRAY 450 ML	62
31387	GRASSO LUBRIFICANTE SPRAY 250 ML	63
31440	LIQUIDO VASCHETTA VETRI - 40° 250 ML	66
31520	ESTINTORE NO FLAME 450 ML	259

ARTICOLO	DESCRIZIONE PRODOTTO	PAG
31700	X-TRA SHAMPOO E CERA 1 LT.	67
31701	NERO GOMME AUTOLUCIDANTE 750ML	61
31702	DETERGENTE CERCHI FLACONE 750 CC.	61
31703	DETERGENTE TESSUTI/MOQUETTE 750 CC.	68
31704	DETERGENTE VETRI FLACONE 750ML	68
31705	SHAMPOO AUTO 1 LITRO	67
31710	SHAMPOO AUTO 5 LITRI	67
31716	IGIENIZ.CLIMATIZZATORE 200 ML	65
31718	PULITORE TESSUTI INTERNI 650 ML	67
31719	LUCIDA CRUSCOTTI SATIN.650 ML	68
31720	LUCIDA CRUSCOTTI LUCID.650 ML	68
32062	PELLE SCAMOSC."EUROTOP"TG. 17 C/CAV.	71
32066	PELLE SCAMOSC."EUROTOP"TG. 25 C/CAV.	71
32074	PELLE SCAMOSC."EUROTOP"TG. 35 C/CAV.	71
32102	2 PANNI PULIZIA GIALLI	70
32111	SPUGNA DAINO CONFEZIONATA	71
32116	25 PANNI CATTURA POLVERE DAINO SPEED	70
32126	PELLE SINTETICA DAINELLA C/CAV.	70
32129	2 PZ.PELLE SINTETICA SCAMOSCIATA NATURALE 36X40 CM	70
32131	PELLE ALCANTARA C/CAV.	71
32133	PANNO IN MICROFIBRA MIS. GRANDE 30X40	71
32135	GOMMINO TERGI ATTACCO BOSCH CM. 61	101
32142	PULIVETRO CM. 25 C/MANICO LEGNO PROFESSIONALE	74
32143	PULIVETRO CM. 25 C/MANICO LEGNO MEDIO	74
32144	PULIVETRO CM. 25	74
32210	IDROCAR PVC	74
32212	IDROCAR CRINE	74
32230	MANICO CM. 180 PER IDROCAR	73
32234	MANICO TELESCOPICO PER IDROCAR	73
32236	IDROSPAZZOLA PER LAVAGGIO HYDROBRUSH	73
32237	MANICO PER IDROSPAZZOLA"HYDROHANDLE"	73
32238	KIT HYDROBRUSH TELESCOPICO	73
32250	SPUGNA KITTY + ABRASIVO PER MOSCERINI	72
32252	SPUGNA KITTY TEDESCA GIGANTE	72
32254	SPUGNA RETTANGOLARE NAZIONALE	72
32256	SPUGNA OVALE	72
32262	SPUGNA "FARFALLA"	72
32314	GUANTO NEVE CON RASCHIAGHIACCIO	75
32316	RASCHIAGHIACCIO "ICE"	75
32323	RASCHIAGHIACCIO CON IMPUGNATURA SOFT	75
35000	MANOMETRO PROVA PRESSIONE PNEUMATICI	264
35005	CP.CINGHIE FISSAGGIO TAURUS 2X250 CM	255
35010	CINGHIA CON CRICC.E 2 GANCI 1X5 M.	255
35015	TAPPO BENZINA UNIVERSALE EMERGENZA	261
35020	MORSETTO STACCA BATT.START AND STOP	260
35025	'NECK CUSHION' CUSCINO APPOGGIACOLLO	257
35030	CONF. 2 PZ. CORDA ELASTICA CM.80	255
35035	CONF. 2 PZ. CORDA ELASTICA CM.150	255
35040	10 FUSIBILI BILAMA OMOLOGATI	262
35045	10 MINI-FUSIBILE BILAMA OMOLOGATI	262
35050	10 FUSIBILI CILINDRICI ASSORTITI	262
35055	ETILOMETRO A LUCE LED E PORTACHIAVI	256
35060	10 PZ.FASCETTE MULTIUSO ACCISIAIO ASS.	258
35065	QUADRUPLA PRESA ACCENDI 12V/24V	263
35070	DP.PRESA MULTIUSO TWO SOCKETS 12/24V	263
35075	CONVERTITORE CORRENTE 150W 12V 220V	263
35085	TROUSSE LAMPADE ALOGENE H1+50% LUM.	265
35090	TROUSSES LAMPADE ALOGENE H4+50% LUM.	265
35095	TROUSSE LAMPADE ALOGENE H7+50% LUM.	265
35100	CAVO ANTIF.C/LUCCHETTO E CHIAVE	258
35105	TORCIA A LED MULTIFUNZIONI	262

ARTICOLO	DESCRIZIONE PRODOTTO	PAG
35110	TORCIA RICARICABILE A LED	262
35115	MARTELLO MULTIFUNZ.EMERGENZA CON	259
35120	POMPA ASPIRA LIQUIDI PROFESSIONALE	260
35125	CHIAVE SVITA FILTRO A NASTRO	264
35130	VENTOSA RIPARA CARROZZERIA E	264
35135	NASTRO AMERICANO 11MX50MM SILVER	257
35140	GIUBBINO ALTA VISIB. GIALLO OMOLOG.	257
35145	GIUBBINO ALTA VISIB. ARANCIO OMOLOG.	257
35150	SET CHIAVE MULTIUSO 25 IN 1 INOX	257
35155	POMPA GONFIATUTTO A 1 CILINDRO	253
35160	CORDA TRAINOCAR 2800 KG. CON FASCIA	264
35165	SET CAVI BATTERIA PROF. 200 AH	254
35170	SET CAVI BATTERIA PROFESS. 400AH.	254
35175	CARICA BATTERIA 4 AMP.12V 230V OMOL.	254
35180	KIT PRONTO SOCCORSO AUTO E FURGONI	256
35185	IMBUTO FLESSIBILE CON FILTRO	260
35190	TRIANGOLO EMERGENZA OMOLOGATO	256
35195	ESTINTORE 1KG. C/MANOMETRO OMOLOGATO	259
35196	ESTINTORE SOS FIRESTOP 1000 ML	259
35200	SBLOCCANTE LUBRIFICANTE SPRAY 250 ML	253
35201	SOS SBLOCCANTE LUBRIFICANTE SPRAY 450 ML	253
35205	GONFIA E RIPARA GOMME 450 ML	253
35208	KIT RIPARA PNEUMATICO SOS	252
35210	TANICA PLASTICA 10 LT. OMOLOGATA	260
35215	TANICA PLASTICA 5 LT.OMOLOGATA	260
35220	SPECCHIO RETROVISORE PER CONTROLLO	258
35225	GUANTI DA LAVORO IN VINILE 15 PZ.	261
35230	PROTEGGI SEDILE ANTERIORE NERO	258
35235	RETE BAGAGLI SAFE BAGGAGES 38X75 CM	265
35240	COPRIAUTO 'CAR TOP' MISURA UNIVERSALE "MODELLO PROTEGGI DAL CALORE"	263
35245	PAIA GUANTI DA LAVORO PROFESSIONALI	261
35250	SET GUANTI 50 PZ UNIVERSALE	261
35255	S.O.S.CARICA BATTERIA+MANTENIMENTO	254
35260	S.O.S. SNOW PIT STOP 8pc	250
35265	S.O.S. SNOW PIT STOP EXTREME 6pc	251
35901	ESPOSITORE A SCALETTA "SOS"	457
36001	CONF. 100 DISCHI "KIENZLE" 125 KOMBI	350
36030NEW	CARTA CARBURANTE 12 MESI	230
39020	SET TAPPETI MOQUETTE ALFA ROMEO MITO	172
39021	SET TAPPETI MOQUETTE ALFA ROMEO GIULIETTA	172
39022	SET TAPPETI MOQUETTE ALFA ROMEO 159	172
39023	SET TAPPETI MOQUETTE AUDI A1	172
39024	SET TAPPETI MOQUETTE AUDI A3 0309	172
39025	SET TAPPETI MOQUETTE AUDI A3 12..	172
39026	SET TAPPETI MOQUETTE AUDI A4 0715	172
39027	SET TAPPETI MOQUETTE AUDI Q5	172
39028	SET TAPPETI MOQUETTE AUDI Q3	172
39029	SET TAPPETI MOQUETTE BMW 1 0411	172
39030	SET TAPPETI MOQUETTE BMW 1 12..	172
39031	SET TAPPETI MOQUETTE BMW 3 0512	172
39032	SET TAPPETI MOQUETTE BMW 3 12..	172
39033	SET TAPPETI MOQUETTE BMW X1 0915	172
39034	SET TAPPETI MOQUETTE BMW X3 10..	172
39035	SET TAPPETI MOQUETTE CITROEN C1 14..	172
39036	SET TAPPETI MOQUETTE CITROEN C3 09..	172
39037	SET TAPPETI MOQUETTE DACIA DUSTER 10..	172
39038	SET TAPPETI MOQUETTE FIAT PANDA 0311	172
39039	SET TAPPETI MOQUETTE FIAT PANDA 12..	172
39040	SET TAPPETI MOQUETTE FIAT 500 07..	172
39041	SET TAPPETI MOQUETTE FIAT 500X 14..	172

ARTICOLO	DESCRIZIONE PRODOTTO	PAG
39042	SET TAPPETI MOQUETTE FIAT 500L 12..	172
39043	SET TAPPETI MOQUETTE FIAT PUNTO 0512	172
39044	SET TAPPETI MOQUETTE FIAT BRAVO 0714	172
39045	SET TAPPETI MOQUETTE FIAT FREEMONT	172
39046	SET TAPPETI MOQUETTE FORD KA 08..	172
39047	SET TAPPETI MOQUETTE FORD FIESTA 08..	172
39048	SET TAPPETI MOQUETTE FORD FOCUS 10...	172
39049	SET TAPPETI MOQUETTE HYUNDAI i10 13..	172
39050	SET TAPPETI MOQUETTE HYUNDAI ix35 0915	172
39051	SET TAPPETI MOQUETTE JEEP RENEGADE	172
39052	SET TAPPETI MOQUETTE KIA PICANTO 11..	172
39053	SET TAPPETI MOQUETTE KIA SPORTAGE 1015	172
39054	SET TAPPETI MOQUETTE LANCIA Y 11..	172
39055	SET TAPPETI MOQUETTE LANDROVER EVOQUE	172
39056	SET TAPPETI MOQUETTE MERCEDES A 0412	172
39057	SET TAPPETI MOQUETTE MERCEDES A 12..	172
39058	SET TAPPETI MOQUETTE MERCEDES B 11..	172
39059	SET TAPPETI MOQUETTE MERCEDES C 15..	172
39060	SET TAPPETI MOQUETTE MERCEDES GLA	172
39061	SET TAPPETI MOQUETTE MERCEDES GLK	172
39062	SET TAPPETI MOQUETTE MINI MINI 0114	172
39063	SET TAPPETI MOQUETTE MINI COUNTRYMAN	172
39064	SET TAPPETI MOQUETTE MITSUBISHI ASX 10..	172
39065	SET TAPPETI MOQUETTE MITSUBISHI OUTLANDER	172
39066	SET TAPPETI MOQUETTE NISSAN JUKE	172
39067	SET TAPPETI MOQUETTE NISSAN MICRA 10..	172
39068	SET TAPPETI MOQUETTE NISSAN QASHQAI 0713	172
39069	SET TAPPETI MOQUETTE NISSAN QASHQAI 13..	172
39070	SET TAPPETI MOQUETTE OPEL AGILA 08..	172
39071	SET TAPPETI MOQUETTE OPEL CORSA 06..	172
39072	SET TAPPETI MOQUETTE OPEL ASTRA 0915	172
39073	SET TAPPETI MOQUETTE OPEL ASTRA 15..	172
39074	SET TAPPETI MOQUETTE OPEL MOKKA	172
39075	SET TAPPETI MOQUETTE OPEL INSIGNA	172
39076	SET TAPPETI MOQUETTE OPEL ZAFIRA 12..	172
39077	SET TAPPETI MOQUETTE PEUGEOT 107	172
39078	SET TAPPETI MOQUETTE PEUGEOT 108	172
39079	SET TAPPETI MOQUETTE PEUGEOT 207	172
39080	SET TAPPETI MOQUETTE PEUGEOT 208	172
39081	SET TAPPETI MOQUETTE PEUGEOT 308 13..	172
39082	SET TAPPETI MOQUETTE RENAULT TWINGO 0714	172
39083	SET TAPPETI MOQUETTE RENAULT TWINGO 14..	172
39084	SET TAPPETI MOQUETTE RENAULT CLIO 12..	172
39085	SET TAPPETI MOQUETTE RENAULT CAPTUR	172
39086	SET TAPPETI MOQUETTE RENAULT KADJAR	172
39087	SET TAPPETI MOQUETTE RENAULT SCENIC 0915	172
39088	SET TAPPETI MOQUETTE SEAT IBIZA 08..	172
39089	SET TAPPETI MOQUETTE SEAT LEON 13..	172
39090	SET TAPPETI MOQUETTE SKODA OCTAVIA 12..	172
39091	SET TAPPETI MOQUETTE SKODA ROOMSTER	172
39092	SET TAPPETI MOQUETTE SKODA YETI	172
39093	SET TAPPETI MOQUETTE SMART SMART 0714	172
39094	SET TAPPETI MOQUETTE SMART SMART 14..	172
39095	SET TAPPETI MOQUETTE SUZUKI JIMNY	172
39096	SET TAPPETI MOQUETTE SUZUKI GRAND VITARA 3P	172
39097	SET TAPPETI MOQUETTE SUZUKI GRAND VITARA 5P	172
39098	SET TAPPETI MOQUETTE TOYOTA AYGO 14..	172
39099	SET TAPPETI MOQUETTE TOYOTA YARIS 11..	172
39100	SET TAPPETI MOQUETTE TOTOTA RAV4 0512	172
39101	SET TAPPETI MOQUETTE VOLKSWAGEN GOLF 0813	172
39102	SET TAPPETI MOQUETTE VOLKSWAGEN GOLF 13..	172

ARTICOLO	DESCRIZIONE PRODOTTO	PAG
39103	SET TAPPETI MOQUETTE VOLKSWAGEN POLO 09..	172
39104	SET TAPPETI MOQUETTE VOLKSWAGEN TIGUAN 0915	172
39105	SET TAPPETI MOQUETTE VOLKSWAGEN TOURAN 1015	172
39106	SET TAPPETI MOQUETTE VOLKSWAGEN UP	172
39107	SET TAPPETI MOQUETTE VOLVO V 50 0412	172
39108	SET TAPPETI MOQUETTE VOLVO V60 11..	172
39109	SET TAPPETI MOQUETTE VOLVO XC 60	172
39110	SET TAPPETI MOQUETTE VOLVO XC 90 0215	172
39620	SET 4 PZ TAPPETI GOMMA ALFA ROMEO MITO	173
39621	SET 4 PZ TAPPETI GOMMA ALFA ROMEO GIULIETTA-FIAT STILO 0208-FIAT BRAVO 0714-LANCIA DELTA 0814	173
39622	SET 4 PZ TAPPETI GOMMA TOYOTA RAV4 DAL 2013	173
39626	SET 4 PZ TAPPETI GOMMA AUDI A4 DAL 2007 AL 2015	173
39627	SET 4 PZ TAPPETI GOMMA AUDI Q5	173
39628	SET 4 PZ TAPPETI GOMMA AUDI Q3	173
39629	SET 4 PZ TAPPETI GOMMA BMW 1 DAL 2004 AL 2011-BMW 1 COUPE' 0714-BMW1 CABRIO 0814-BMW X1 0915	173
39631	SET 4 PZ TAPPETI GOMMA BMW 3 DAL 2005 AL 2012	173
39632	SET 4 PZ TAPPETI GOMMA BMW 3 DAL 2011	173
39634	SET 4 PZ TAPPETI GOMMA BMW X3 DAL 2010 E BMW X4 DAL 2014	173
39636	SET 4 PZ TAPPETI GOMMA CITROEN C3 DAL 2009	173
39637	SET 4 PZ TAPPETI GOMMA DACIA DUSTER DAL 2010- DACIA LOGAN DAL 2008-DACIA SANDERO DAL 2008 AL 2012	173
39638	SET 4 PZ TAPPETI GOMMA FIAT PANDA DAL 2003 AL 2012-PANDA DAL 2012-FORD KA DAL 2008-FIAT 500/C	173
39641	SET 4 PZ TAPPETI GOMMA FIAT 500X DAL 2014 -JEEP RENEGADE DAL 2014	173
39642	SET 4 PZ TAPPETI GOMMA FIAT 500L 12	173
39643	SET 4 PZ TAPPETI GOMMA FIAT G.PUNTO 2005	173
39645	SET 4 PZ TAPPETI GOMMA FIAT FREEMONT	173
39648	SET 4 PZ TAPPETI GOMMA FORD FIESTA DAL 2008	173
39649	SET 4 PZ TAPPETI GOMMA FORD FOCUS DAL 2010	173
39651	SET 4 PZ TAPPETI GOMMA HYUNDAI TUCSON DAL 2015- KIA SPORTAGE DAL 2015	173
39652	SET 4 PZ TAPPETI GOMMA HYUNDAI ix35 DAL 2009 al 2015- HYUNDAI KIA SPORTAGE DAL 2010 al 2015	173
39656	SET 4 PZ. TAPPETI GOMMA LANCIA Y 11	173
39657	SET 4 PZ. TAPPETI GOMMA LANDROVER EVOQUE	173
39659	SET 4 PZ TAPPETI GOMMA MERCEDES A DAL 2012-MERCEDES CLA DAL 2013-MERCEDES GLA DAL 2013-B	173
39661	SET 4 PZ TAPPETI GOMMA MERCEDES C DAL 2007 AL 2015	173
39662	SET 4 PZ TAPPETI GOMMA MERCEDES C 15	173
39664	SET 4 PZ TAPPETI GOMMA MERCEDES GLK	173
39665	SET 4 PZ TAPPETI GOMMA MINI MINI DAL 2001 AL 2014	173
39669	SET 4 PZ TAPPETI GOMMA NISSAN JUKE	173
39671	SET 4 PZ TAPPETI GOMMA NISSAN QASHQAI DAL 2007 AL 2013	173
39672	SET 4 PZ TAPPETI GOMMA NISSAN QASHQAI DAL 2013	173
39674	SET 4 PZ TAPPETI GOMMA OPEL CORSA DAL 2006-OPEL ADAM	173
39675	SET 4 PZ TAPPETI GOMMA OPEL ASTRA DAL 2009 AL 2015-CHEV.ORLANDO-CHEV CRUZE	173
39676	SET 4 PZ TAPPETI GOMMA OPEL ASTRA DAL 2015	173
39677	SET 4 PZ TAPPETI GOMMA OPEL MOKKA-CHEV TRAX	173
39678	SET 4 PZ TAPPETI GOMMA OPEL INSIGNA	173
39679	SET 4 PZ TAPPETI GOMMA OPEL ZAFIRA DAL 2012	173
39683	SET 4 PZ TAPPETI GOMMA PEUGEOT 208-PEUGEOT 2008	173
39687	SET 4 PZ TAPPETI GOMMA RENAULT CLIO DAL 2012	173
39688	SET 4 PZ TAPPETI GOMMA RENAULT CAPTUR	173
39689	SET 4 PZ TAPPETI GOMMA RENAULT KADJAR	173
39690	SET 4 PZ TAPPETI GOMMA RENAULT SCENIC DAL 2009 AL 2015 E RENAULT SCENIC GRANDTOUR	173
39691	SET 4 PZ TAPPETI GOMMA SEAT IBIZA DAL 2008 E SKODA FABIA DAL 2014	173
39693	SET 4 PZ TAPPETI GOMMA SKODA OCTAVIA DAL 2012	173

ARTICOLO	DESCRIZIONE PRODOTTO	PAG
39696	SET 4 PZ TAPPETI GOMMA SMART 0714	173
39697	SET 4 PZ TAPPETI GOMMA SMART 14	173
39699	SET 4 PZ TAPPETI GOMMA SUZUKI VITARA DAL 2014	173
39701	SET 4 PZ TAPPETI GOMMA TOYOTA YARIS DAL 2011	173
39702	SET 4 PZ TAPPETI GOMMATOYOTA RAV4 DAL 2005 AL 2012	173
39703	SET 4 PZ TAPPETI GOMMA VOLKSWAGEN GOLF VI DAL 2008 AL 2013SKODA YETI-SEAT TOLEDO 0409-SKODA OCTAVIA 0412GOLF V 0308-SEAT LEON 0512-JETTA 0510-SCIROCOCO 07	173
39704	SET 4 PZ TAPPETI GOMMA VOLKSWAGEN GOLF VII DAL 2012AUDI A3 DAL 2012-SEAT LEON DAL 2013	173
39705	SET 4 PZ TAPPETI GOMMA VOLKSWAGEN POLO DAL 2009	173
39706	SET 4 PZ TAPPETI GOMMA VOLKSWAGEN TIGUAN DAL 2007 AL 2015	173
39707	SET 4 PZ TAPPETI GOMMA VOLKSWAGEN TOURAN DAL 2003 AL 2015	173
39709	SET 4 PZ TAPPETI GOMMA VOLVO V50 DAL 2004 AL 2012-S40 DAL 2004 AL 2012- C30 DAL 2006 AL 2012	173
39710	SET 4 PZ TAPPETI GOMMA VOLVO V60 DAL 2011 -S80 DAL 2006 AL 2015-V70 DAL 2011 AL 2015- XC70 DAL 2006 AL 2015	173
39711	SET 4 PZ TAPPETI GOMMA VOLVO XC 60	173
39712	SET 4 PZ TAPPETI GOMMA VOLVO XC 90 DAL 2002 AL 2015	173
39990	ESPOSITORE TAPPETI TOTEM	460
55079	X-TRA LUBRIFIC.PER UTENSILI E COMPR.	18
55101	ACCUMULATORE 40 AMPERE "EXTRA POWER"	25
55104	ACCUMULATORE 45 AMPERE "EXTRA POWER"	25
55107	ACCUMULATORE 50 AMPERE "EXTRA POWER"	25
55110	ACCUMULATORE 55 AMPERE "EXTRA POWER"	26
55113	ACCUMULATORE 60 AMPERE "EXTRA POWER"	26
55116	ACCUMULATORE 70 AMPERE "EXTRA POWER"	26
55119	ACCUMULATORE 80 AMPERE "EXTRA POWER"	27
55122	ACCUMULATORE 90 AMPERE"EXTRA POWER" SENZA MANUTENZ.	27
55125	ACCUMULATORE 100 AMPERE LONG "EXTRA POWER"	27
55518	BOTTARI BASE MULTIGRADE 15W-40 1LT 12X1	16
55519	BOTTARI BASE MULTIGRADE 15W-40 4LT 6X4	16
55520	BOTTARI SINT PLUS 10W-40 1 L 12X1	16
55521	BOTTARI SINT PLUS 10W-40 4L 6X4	16
55522	BOTTARI ULTRA SINT 5W-40 1 L 12X1	17
55523	BOTTARI ULTRA SINT 5W-40 4 L 6X4	17
55524	BOTTARI ULTRA SINT 5W-30 C3 1 Lt 12x1	17
55525N	BOTTARI ULTRA SINT 5W-30 C3 4L 6x4	17
55550	BOTTARI MOTO ULTRA TOP 50 2T 1 L 12x1	18
55551	BOTTARI MOTO SINT TOP 50 2T 1 L 12x1	18
55552	BOTTARI MOTO SINT TOP 4T 10W40 1 L 12x1	18
60000	LAMPADA 12V-35-35 WATT P15D	373
60005	LAMPADA 12V-23 WATT BA9S BLU	373
60007	LAMPADA 12V-23WATT BA9S ARANCIO	373
60010	LAMPADA 12V 15WATT P26S BIANCA	373
60011	LAMPADA 12V 5WATT BA9S ARANCIO	373
60015	LAMPADA 12V-5 WATT T10 BIANCA	373
60016	LAMPADA 12V 5 WATT T10 ARANCIO	373
60017	LAMPADA 12V 5 WATT T10 BLU	373
60025	LAMPADA 12V 23/8 WATT BIANCA	373
60030	LAMPADA 12V 23 WATT BA15S BIANCA	373
60031	LAMPADA 12V 23 WATT BA15S BLU	373
60032	LAMPADA 12V 23WATT BA15S ARANCIO	373
60040	LAMPADA 12V 10 WATT BA15S BIANCA	374
60041	LAMPADA 12V 10 WATT BA15S BLU	374
60042	LAMPADA 12V 10 WATT BA15S ARANCIO	374
60047	LAMPADA 12V 5/21WATT BAY15D BIANCA	374
60052	LAMPADA 12V 5 WATT T10 ARANCIO	374
60053	LAMPADA 12V 5 WATT T10 ROSSO	374
60061	LAMPADA A LED 12V-23WATT BA9S BLU	374
60062	LAMPADA LED 12V 23WATT BA9S ARANCIO	374



ARTICOLO	DESCRIZIONE PRODOTTO	PAG
60070	LAMPADA 12V T5 BIANCA	375
60071	LAMPADA 12V T5 ROSSO	375
60072	LAMPADA 12V T5 BLU	375
60073	LAMPADA 12V T5 VERDE	375
60074	LAMPADA 12V T5 ROSA	375
60075	LAMPADA 12V T5 ARANCIO	375
60080	LAMPADA 12V 55WATT H1 P14,5S	130
60081	LAMPADA 12V H1 PLATINUM WHITE	375
60082	LAMPADA 12V H1 PLATINUM RAIOW BLU	375
60086	LAMPADA 12V H4 PLATINUM WHITE	375
60090	LAMPADA 12V 55 WATT H7 PX22D	374
60091	LAMPADA 12V H7 PLATINUM WHITE	375
60092	LAMPADA 12V H7 PLATINUM RAINBOW BLU	375
60103	TERMOMETRO LUMINOSO LED BLU "KNOW"	380
60106	CP. LUCI LED STROBOSCOP. SPYKO BLU	376
60107	CPLUCI LED STOBOSCOP.SPYKO ROSSE	376
60108	CPLUCI LED STROBOSCOP.SPYKO VERDI	376
60109	CPLUCI LED STROBOSCOP.SPYKO VIOLA	376
60110	CPLUCI LED STROBOSCOP.SPYKO BIANCH	376
60112	COMANDO DISTANZA PER LUCI NEON O.K.	381
60115	2PZ.STRISCIE FLESS.3LED SUNRISE BLU	379
60116	2PZ.STRIS.FLESS.3LED SUNRISE VERDE	379
60117	2PZ.STRIS.FLESS.3LED SUNRISE BIANCH	379
60120	STRISCIA ADESIVA FLESS.5 LED 13CM	379
60121	STRISCIA ADES.FLESS.5 LED 13 CM SURVIVOR VERDE	379
60122	STRISCIA ADESIVA FLESS. 5 LED 13 CM SURVIVOR BIANCA	379
60125	STRISCIA ADESIVA FLESS.5 LED 30 CM DEVIL BLU	379
60126	STRISCIA ADESIVA FLESS.5 LED 30 CM DEVIL VERDE	379
60127	STRISCIA ADESIVA FLESS.5 LED 30 CM DEVIL BIANCA	379
60130	COPRIVAL.PNEUM.LUMINOSO IDEA LED BLU	378
60131	COPRIV.PNEUM.LUMINOSO IDEA LED ROSS	378
60132	COPRIV.PNEUM.LUMINOSO IDEA LED VERD	378
60133	COPRIV.PNEUM.LUMINOSO IDEA LED VIOL	378
60134	COPRIV.PNEUM.LUMIN.IDEA LED BIANCO	378
60142	CPLUCI LED VERDE "DOUBLE"	376
60145	CPLUCI STROBO LITE FLASHING BLU	378
60146	CPLUCI STROBO LITE FLASHING ROSSO	378
60147	CPLUCI STROBO LITE FLASHING VERDE	378
60148	CPLUCI STROBO LITE FLASHING BIANCO	378
60149	CPLUCI STROBO LITE FLASHING ARANCI	378
60151	CPLUCI ORIENTABILI LED BIANCO TWIN	376
60154	CPLUCI LED ORIENTABILI VERDE TWIN	376
60160	NEON LUMINOSO MOTO "CRIME" BLU	379
60161	NEON LUMINOSO MOTO CRIME VERDE	379
60162	NEON LUMINOSO MOTO CRIME BIANCO	379
60163	NEON LUMINOSO MOTO CRIME VIOLA	379
60164	NEON LUMINOSO MOTO CRIME ROSSO	379
60251	CPLUCI ADES.LED BLU DOUBLE LAMP	380
60252	CPLUCI ADES.LED VERDE DOUBLE LAMP	380
60253	CPLUCI LED ADES.ROSSO DOUBLE LAMP	380
60254	CPLUCI ADES.LED BIANCO DOUBLE LAMP	380
60255	CPLUCI ADES.LED ARANCIO DOUBLE LAM	380
60290	CPLUCI DEC.TARGA 12LED ROSSI 2 FUN	380
60291	CPLUCI DEC.TARGA 12 LED BLU 2 FUNZ	380
60295	CPLUCI NEON 17CM BLU STRANGE	378
60296	CPLUCI NEON 17CM STRANGE ROSSO	378
60297	CPLUCI NEON 17 CM VERDE STRANGE	378
60298	CPLUCI NEON 17CM VIOLA STRANGE	378
60299	CPLUCI NEON 17 CM BIANCO STRANGE	378
60310	CPLUCI ADES.2LED BLU "SNAIL"	380
60311	CPLUCI ADES.2 LED BIANCHI "SNAIL"	380

ARTICOLO	DESCRIZIONE PRODOTTO	PAG
60312	CP.LUCI ADES.2 LED ROSSO "SNAIL"	380
60313	CP.LUCI ADES.2 LED VIOLA "SNAIL"	380
60315	PROIETT.LUMIN. LED 7 COLORI STRANGE	381
60316	PROIETT.LUMINOSO LED BLU STRANGE	381
60317	PROIETT.LUMINOSO LED BIANCO STRANGE	381
60318	PROIETT.LUMINOSO LED ROSSO STRANGE	381
60319	PROIETT.LUMINOSO LED VERDE STRANGE	381
60320	PROIETT.LUMINOSO LED VIOLA STRANGE	381
60321	CPLUCI DIR.16LED FLASH FUTUR ARANC	378
60323	CPLUCI DIR.16LED FLASH FUTURE ROSS	378
60324	CPLUCI DIR.16LED FLASH FUTUR VERDE	378
60330	CPLUCI 3 LED BLU WIZARD	381
60331	CPLUCI 3 LED ROSSO WIZARD	381
60332	CPLUCI 3 LED VERDE WIZARD	381
60333	CPLUCI 3 LED ARANCIO WIZARD	381
60334	CPLUCI 3 LED BIANCO WIZARD	381
60335	CPLUCI 3 LED VIOLA WIZARD	381
60337	SET 4 LED LUMINOSI ROSSO "FIRST"	377
60338	SET 4 LED LUMINOSI VERDE "FIRST"	377
60339	SET 4 LED LUMINOSI VIOLA "FIRST"	377
60340	SET 4 LED LUMINOSI BIANCO "FIRST"	377
60345	CPLUCI LED BLU+LUCE STROBO BIANCA	381
60346	CPLUCI LED ARANCIO+STROBO BIANCA	381
60347	CPLUCI LED ROSSO+LUCE STROBO BIANC	381
60348	CPLUCI LED BIANCA+LUCE STROBO BIAN	381
60360	PROIETT.LUMINOSO 2 LED ROSSO/BLU	376
60361	PROIETT.LUMINOSO 2 LED BIANCA/BLU	376
60362	PROIETT.LUMINOSO 2 LED BLU	376
60363	PROIETT.LUMINOSO 2 LED BIANCA	376
60364	PROIETT.LUMINOSO 2 LED VERDE	376
60365	PROIETT.LUMINOSO 2 LED ROSSA	376
60370	CPLUCI LED DECOR.TARGA BLU ORIENT.	382
60371	CPLUCI LED DECOR.TARGA BIAN.orient	382
60372	CPLUCI LED DECOR.TARGA ROSSO ORIE	382
60373	CPLUCI LED DEC.TARGA VERDE ORIENT.	382
60374	CPLUCI LED DEC.TARGA VIOLA ORIENT.	382
60382	CPLUCI LED DECOR.TARGA BLU STRANGE	382
60383	CPLUCI LED DEC.TARGA VERDE STRANGE	382
60384	CPLUCI LED DEC.TARGA ROSSO STRANGE	382
60385	CPLUCI LED DEC.TARGA VERDE STRANGE	382
60386	CPLUCI DECOR.TARGA VIOLA STRANGE	382
60390	CPLUCI LED DECOR.TARGA BLU SNAKE	382
60391	CPLUCI LED DECOR.TARGA BIANCO SNAK	382
60392	CPLUCI LED DECOR.TARGA ROSSO SNAK	382
60393	CPLUCI LED DECOR.TARGA VERDE SNAKE	382
60394	CPLUCI LED DECOR.TARGA VIOLA SNAKE	382
60399	CPLUCI ADESIVE "SLICK"	382
60591	SET 4PZ. COPRIBULLONI ANODIZZATI CROMATI D.8MM	384
60592	SET 4PZ. COPRIBULLONI ANODIZZATI BLU D.8MM	384
60593	SET 4PZ. COPRIBULLONI ANODIZZATI ROSSO D.8MM	384
60594	SET 4PZ. COPRIBULLONI ANODIZZATI CROMATI D.12MM	384
60595	SET 4PZ. COPRIBULLONI ANODIZZATI BLU D.12MM	384
60596	SET 4PZ. COPRIBULLONI ANODIZZATI ROSSO D.12MM	384
60597	SET 4PZ. COPRIBULLONI ANODIZZATI CROMATO D.14MM	384
60598	SET 4PZ. COPRIBULLONI ANODIZZATI BLU D.14MM	384
60599	SET 4PZ. COPRIBULLONI ANODIZZATI ROSSO D.14MM	384
60600	BULLONI DECORATIVI ARGENTO "BOSS"	385
60601	BULLONI DECORATIVI ROSSO "BOSS"	385
60602	BULLONI DECORATIVI BLU "BOSS"	385
60618	MANOP.SCOOTER ERGON.D.22-25MM OVER	383
60619	CP.MANOP.SCOOTER D.22-25MM ARGENTO	383

ARTICOLO	DESCRIZIONE PRODOTTO	PAG
60620	CP.MANOPOLE SCOOTER D.22-25MM NERE	383
60621	CP.MANOPOLE SCOOTER D.22-25MM BLU	383
60622	CP.MANOPOLE SCOOTER 22-25 MM ROSSE	383
60643	CP.SPECCHII UNIV.VISION PLUS NERI 8 MM	383
60673	PROTEGGI SERBAT.NERO MOTO FREE STYL	387
60682	STRISCIE ADES.PER RUOTE ROSSO FLUO	388
60683	STRISCIE ADES.PER RUOTE GIALLO FLUO	388
60685	PORTACHIAVI IN ALLUMINIO "MUFFLER"	385
60686	PORTACHIAVE IN ALLUMINIO "SHOCK"	385
60687	PORTACHIAVI SILVER 2 LED BLU "INK"	385
60688	PORTACHIAVI SILVER 2 LED ROSSO "INK"	385
60689	PORTACHIAVI SILVER 2 LED VERDI "INK"	385
60690	PORTACHIAVI SILVER 2 LED VIOLA "INK"	385
60691	PORTACHIAVI SILVER 2 LED BIANCHI "INK"	385
60700	ALLARME ELETTRONICO DA MOTO	377
60710	FILTRO UNIV.BENZINA MOTO "PRESTON"	370
60711	FILTRO BENZINA UNIV.ALL.MOTO X-LITE	386
60712	MINI FILTRO ARIA SPORT.AIR-CLEAN RED	386
60714	MINI FILTRO ARIA SPORT.AIR-CLEAN BLU	386
60715	INTERFONO MOTO DI ALTA QUALITA'	372
60716	INTERFONO "COMMUNICATION"	372
60717	INTERFONO "TALK"	372
60719	GONFIA E RIPARA PNEUMATICI 450 ML	388
60734	PROTETTIVO PLASTICA EST/INT "FILM"	388
60736	TERGIVISIERS E TERGICUPOLINI "SLEEVE"	389
60737	IMPERMEABILIZ.TESSUTI "WATERPROOF"	388
60738	PULITORE CASCO "SHADOW"	389
60739	ANTIAPPAN.VISIERS E CUPOLINI "NO FOG"	388
60745	PANNO LUCIDANTE MICROFIBRA TRATT.	389
60746	GUANTO LUCID.IN MICROFIBRA "LUXURY"	389
60761	CP. COPRIVALVOLE PNEUM.RACE NERE	384
60763	CP.COPRIVALVOLE PNEUM.RACE ROSSO	384
60764	CP.COPRIVALVOLE PNEUM. YEH ARGENTO	385
60765	CP. COPRIVALVOLE PNEUM.YEH NERE	385
60766	CP.COPRIVALVOLE PNEUM.YEH BLU	385
60767	CP. COPRIVALVOLE PNEUM.YEH ROSSE	385
60768	COPRIVALVOLE PNEUM."CRISTAL"ARGENTO	384
60769	COPRIVALVOLE PNEUM."CRISTAL" NERO	384
60771	COPRIVALVOLE PNEUM."CRISTAL" ROSSO	384
60780	CP.STABILIZ.MANUBRIO "ZENITH"ARGENTO	384
60781	CP.STABILIZ.MANUBRIO "ZENITH" NERO	384
60782	CP.STABILIZ. MANUBRIO "ZENITH" BLU	384
60783	CP.STABILIZ.MANUBRIO "ZENITH" ROSSO	384
60784	CP.STABILIZ.MANUBRIO "INDY" SILVER	384
60785	CP.STABILIZ. MANUBRIO "INDY" NERO	384
60787	CP. STABILIZ.MANUBRIO "INDY" ROSSO	384
60801	PELL.FARI E CUPOL.VISUAL PLUS RAINB.	387
60802	PELL.FARI E CUPOL.VISUAL PLUS GIALLO	387
60810	COPRIFILO CROM. 150CM D.6 MM "YORK"	387
60811	COPRIFILO BLU 150CM D.6 MM "YORK"	387
60812	COPRIFILO ROSSO D.6 MM 150CM "YORK"	387
60816	PROFILO ADESIVO CROM. 4 MT "PASSION	387
60820	KIT 6 PZ.CATARINF.R.REFLEX PLUS ROSSI	387
60821	KIT 6PZ.CATARINF.R.REFLEX PLUS BIANC	387
60822	KIT 6PZ.CATARINF.R.REFLEX PLUS BLU	387
60823	KIT 6PZ.CATARINF.R.REFLEX PLUS ARANC	387
60824	KIT 6 PZ.CATARINF.R.REFLEX PLUS VERD	387
60825	KIT 6 PZ.CATARINF.R.REFLEX ROSSO	387
60826	KIT 6 PZ.CATARINF.R. REFLEX BIANCO	387
60827	KIT 6 PZ.CATARINF.R. REFLEX BLU	387
60828	KIT 6 PZ.CATARINF.R.REFLEX ARANCIO	387

ARTICOLO	DESCRIZIONE PRODOTTO	PAG
60829	KIT 6 PZ.CATARINF.R. REFLEX VERDE	387
60830	PORTA ASSICUR.IN ALLUM.HYDRO ARGENT	386
60831	PORTA ASSICURAZ.IN ALLUM.HYDRO NERO	386
60832	PORTA ASSICURAZ.IN ALLUM. HYDRO BLU	386
60833	PORTA ASSICURAZ.IN ALLUM.HYDRO ROSS	386
60834	PORTA ASSICUR.IN ALL.HYDRO CARBONIO	386
60841	BORDINO COPRIFINITURE TRIM NERO	388
60842	BORDINO COPRIFINITURE TRIM BLU	388
60843	BORDINO COPRIFINITURE TRIM ROSSO	388
60844	BORDINO COPRIFINITURE TRIM CARBONIO	388
60858	PEDALIERA MOTO-SCOOTER START SILVER	386
60859	PEDALIERA MOTO E SCOOTER START RED	386
60911	KIT RIPARA PNEUMATICO MOTO E SCOOTER	370
60920	BATT.MOTO/SCOOTER ACIDO PREDOS. 4AH	371
60921	BATT.MOTO/SCOOTER ACIDO PREDOS. 7AH	371
60922	BATT.MOTO/SCOOTER ACIDO PREDOS. 9AH	371
60923	BATT.MOTO/SCOOTER ACIDO PREDOS.12AH	371
60924	BATT.MOTO/SCOOTER ACIDO PREDOS.14AH	371
60927	BATT.MOTO/SCOOTER SENZA MANUTENZ.4AH	371
60928	BATT.MOTO/SCOOTER SENZA MANUTENZ.7AH	371
60929	BATT.MOTO/SCOOTER SENZA MANUTENZ.7AH	371
60930	BATT.MOTO/SCOOTER SENZA MANUTENZ.9AH	371
60975	COPRIMOTO IN NYLON ANTISTRAP.SIZE 1	368
60976	COPRIMOTO IN NYLON ANTISTRAP.SIZE 2	368
60980	COPRIMOTO FELPATO MOD.LUSSO SIZE 1	368
60981	COPRIMOTO FELPATO MOD.LUSSO SIZE 2	368
60993	COPRIMOTO SILVER TECH MODELLO 1 PICCOLO/MEDIO	368
60996	COPRIMOTO SILVER TECH MODELLO 2 LARGE/EXTRALARGE	368
62041	GIACCA CORDURA NERA/ROSSA L DIKINSON	362
62042	GIAC.CORDURA NERA/ROSSA XL DIKINSON	362
62043	GIAC.CORDURA NERA/ROSSA XXL DIKINSON	362
62047	GIACCA CORDURA NERA/BLU XL DIKINSON	362
62048	GIAC.CORDURA NERA/BLU XXL DIKINSON	362
62386	GIACCA LADY ROSSA/BIANCA XS-LIBERTY	364
62387	GIACCA LADY ROSSA/BIANCA S-LIBERTY	364
62388	GIACCA LADY ROSSA/BIANCA M-LIBERTY	364
62389	GIACCA LADY ROSSA/BIANCA L-LIBERTY	364
62390	GIACCA LADY ROSA/BIANCA XS LIBERTY	364
62391	GIACCA LADY ROSA/BIANCA S LIBERTY	364
62392	GIACCA LADY ROSA/BIANCA M LIBERTY	364
62394	GIACCA LADY AZZUR/BIANCA XS-LIBERTY	364
62395	GIACCA LADY AZZUR/BIANCA S-LIBERTY	364
62396	GIACCA LADY AZZUR/BIANCA M-LIBERTY	364
62397	GIACCA LADY AZZUR/BIANCA L-LIBERTY	364
62401	GIACCA PELLE NERA L ROAD RUNNER	362
62402	GIACCA PELLE NERA XL ROAD RUNNER	362
62406	GIAC.PELLE NERA/BIANCA L ROAD RUNNER	362
62407	GIAC.PELLE NERA/BIA XL ROAD RUNNER	362
62420	GIACCA PELLE CORDURA NERA M BROOKS	363
62421	GIACCA PELLE CORDURA NERA L BROOKS	363
62422	GIACCA PELLE CORDURA NERA XL BROOKS	363
62423	GIACCA PELLE CORDURA NERA XXL BROOK	363
62429	GIACCA R.EVOL TIFFANY	362
62600	COPRISCARPE IMPERMEABILE	366
62601	SALVASCARPE MODELLO 1 IN PELLE	366
62604	COPRIMANI MODELLO 1 "MET"	366
62650	TUTA INTERA IMPERM. NERA M ADMIRAL	365
62651	TUTA INTERA IMPERM. NERA L ADMIRAL	365
62652	TUTA INTERA IMPERM. NERA XL ADMIRAL	365
62654	PANTALONI IMPERM.ANTIPIOGGIA SURE M	365
62655	PANTALONI IMPERM.ANTIPIOGGIA L SURE	365

ARTICOLO	DESCRIZIONE PRODOTTO	PAG
62676	SOTTOCASCO IN PAIL BLU YAMAKA	367
62678	SOTTOC.INTEGR.IN SETA 100%"GOROTEX" ROSSO TAGLIA UNICA	367
62679	SOTTOC.INTEGR.IN SETA 100%"GOROTEX" BLU TAGLIA UNICA	367
62681	SOTTOCASCO IN PAIL NERO TAGLIA UNICA	367
62683	PROTEZIONE SALVACOLLO UNIV. POLAR	366
62685	PROTEZ.SALVACOLLO C/CERNIERA L.RELA	366
62690	FOULAR MOTOCICLISTA BK/WH/RD GANGSTER	367
62691	FOULAR MOTOCICLISTA FANTASY	367
62815	PAIA GUANTI PELLE C/PROTEZ.CARBON.	360
63990 XS PINK	PAIA GUANTI TG. XS ROSA	360
63991 L PINK	PAIA GUANTI TG. L ROSA	360
63991 L VIOLET	PAIA GUANTI TG. L VIOLA	360
63991 M PINK	PAIA GUANTI TG. M ROSA	360
63991 M VIOLET	PAIA GUANTI TG. M VIOLA	360
63997	STIVALI MOTO TAGLIA 45	367
64001	OCCHIALI MOTO OVALI" PREDATOR" CROM.	361
64002	OCCHIALI "ATOMIC" NERI MOTOCICLISTA	361
64006	OCCHIALI MOTO ROTONDI THUNDER NERI	361
64650	CASCO PELLE "CLASS" NERO-LUC. S	359
64651	CASCO PELLE "CLASS" NERO-LUC. M	359
64652	CASCO PELLE "CLASS" NERO-LUC. L	359
64653	CASCO PELLE "CLASS" NERO-LUC. XL	359
64910	BLOCCADISCO SPEC.D.5.5 CROM.ANTIACQ	369
64911	BLOCCADISCO SPEC.D.10 CROM.ANTIACQU	369
64916	CAVO COLLEGA BLOCCADIS./MANOP.1500M	370
64921	CAVO ANTIFURTO MOTO MAGNUM 66	369
64933	CATENA RIC.ALLUMINIO "NO PROBLEM"	369
67999	CATENE NEVE "ROMBO"VAN/4X4 MIS 190	148
68000	CATENE NEVE "ROMBO"VAN/4X4 MIS 200	148
68001	CATENE NEVE "ROMBO"VAN/4X4 MIS 210	148
68002	CATENE NEVE "ROMBO"VAN/4X4 MIS 220	148
68003	CATENE NEVE "ROMBO"VAN/4X4 MIS 225	148
68004	CATENE NEVE "ROMBO"VAN/4X4 MIS 230	148
68005	CATENE NEVE "ROMBO"VAN/4X4 MIS 240	148
68006	CATENE NEVE "ROMBO"VAN/4X4 MIS 245	148
68007	CATENE NEVE "ROMBO"VAN/4X4 MIS 247	148
68008	CATENE NEVE "ROMBO"VAN/4X4 MIS 248	148
68009	CATENE NEVE "ROMBO"VAN/4X4 MIS 250	148
68010	CATENE NEVE "ROMBO"VAN/4X4 MIS 255	148
68011	CATENE NEVE "ROMBO"VAN/4X4 MIS 260	148
68012	CATENE NEVE "ROMBO"VAN/4X4 MIS 265	148
68013	CATENE NEVE "ROMBO"VAN/4X4 MIS 270	148
68014	CATENE NEVE "ROMBO"VAN/4X4 MIS 275	148
68029	CATENE NEVE "TRUCK" MIS 260	153
68030	CATENE NEVE "TRUCK" MIS 310	153
68040	CATENE NEVE "TRUCK" MIS 520	153
68041	BOTTARI SNOWSOCKS SMALL	152
68042	BOTTARI SNOWSOCKS MEDIUM	152
68043	BOTTARI SNOWSOCKS LARGE	152
72007	GIACCA "INDIANAPOLIS" NERO/BLU - L	364
72008	GIACCA "INDIANAPOLIS" NERO/BLU - XL	364
72009	GIACCA INDIANAPOLIS NERO/BLU XXL	364
72490	GIACCA IMPERMEABILE NERA OXFORD -M	364
72491	GIACCA IMPERMEABILE NERA OXFORD -L	364
72492	GIACCA IMPERMEABILE NERA OXFORD -XL	364
72493	GIACCA IMPERMEABILE NERA OXFORD-XXLGulf	364
76010	GULF CATENA NEVE 7MM 060	142
76011	GULF CATENA NEVE 7MM 065	142
76012	GULF CATENA NEVE 7MM 070	142
76013	GULF CATENA NEVE 7MM 080	142
76014	GULF CATENA NEVE 7MM 090	142

ARTICOLO	DESCRIZIONE PRODOTTO	PAG
76015	GULF CATENA NEVE 7MM 100	142
76016	GULF CATENA NEVE 7MM 110	142
76017	GULF CATENA NEVE 7MM 120	142
76018	GULF CATENA NEVE 7MM 130	142
76099	GULF PANNO IN PVA 43x32cm	60
76100	GULF PANNO IN MICROFIBRA 30X40 CM	60
76101	GULF PANNO MICROFIBRA	60
76102	GULF PANNO MICROFIBRA CARROZZ.	60
76110	GULF SALVIETTE UMIDIFICATE PUL. PLASTICHE LUCIDO 20 PZ.	58
76111	GULF SALVIETTE UMIDIFICATE PUL. PLASTICHE OPACO 20 PZ.	58
76113	GULF SALVIETTE UMIDIFICATE PUL. VETRI 20 PZ.	58
76114	GULF SALVIETTE UMIDIFICATE PUL. TRATTAMENTO PELLE 20 PZ.	59
76115	GULF SALVIETTE UMIDIFICATE PUL. INTERNI E TESSUTI 20 PZ.	59
76120BLUE	GULF FODERA UNIVERSALE NERO-BLU	211
76120GREY	GULF FODERA UNIVERSALE NERO-GRIGIO	211
76120RED	GULF FODERA UNIVERSALE NERO-ROSSO	211
77007	H1 12V 55W ALOGENA + 70% SILVER GOODYEAR, BLISTER	116
77008	LAMP.12 V.H4 60/55W P43T +70% SILVER GOODYEAR, BLISTER	116
77009	LAMPADA H7 12V 55W +70% SILVER GOODYEAR, BLISTER	116
77010	LAMPADA 12V H1 55W IN BLISTER, PLATINUM GOODYEAR, +100%	116
77011	LAMP.12 V.H4 60/55W P43T +100% GOODYEAR, PLATINUM BLISTER	116
77012	LAMPADA H7 12V 55W +100% PLATINUM GOODYEAR, BLISTER	116
77013	2 LAMPADE 12V H1 55W IN BLISTER, PLATINUM GOODYEAR, +100%	116
77014	2 LAMP.12 V.H4 60/55W P43T +100% GOODYEAR, PLATINUM BLISTER	116
77015	2 LAMPADE H7 12V 55W +100% PLATINUM GOODYEAR, BLISTER	116
77016	2 LAMPADE 12V H1 55W IN BLISTER, ULTRA CRYSTAL WHITE GOODYEAR, +100%	117
77017	2 LAMP.12 V.H4 60/55W P43T +100% GOODYEAR, ULTRA CRYSTAL WHITE BLISTER	117
77018	2 LAMPADE H7 12V 55W +100% ULTRA CRYSTAL WHITE GOODYEAR, BLISTER	117
77019	2 LAMPADE 12V H1 55W IN BLISTER, ULTRA BLUE VISION GOODYEAR, +100%	117
77020	2 LAMP.12 V.H4 60/55W P43T +100% GOODYEAR, ULTRA BLUE VISION BLISTER	117
77021	2 LAMPADE H7 12V 55W +100% ULTRA BLUE VISION GOODYEAR, BLISTER	117
77022	H1 12V 55W ALOGENA GOODYEAR, BOX	118
77023	LAMP.12 V.H4 60/55W P43T GOODYEAR, BOX	118
77024	LAMPADA H7 12V 55W SILVER GOODYEAR, BOX	118
77025	2 PZ LAMP.12V. 21W BA15S BLIS.05103 GOODYEAR	117
77026	2PZ LAMP.12V 5/21W BAY15D BLIS. GOODYEAR	117
77027	2 PZ LAMP.12V 5W BA15S BLIS. GOODYEAR	118
77029	2 PZ LAMPADE 12V 5W T 10 IN BLISTER GOODYEAR	118
77031	CONF.2PZ.LAMPADE 12V.5W 10,5X38 BLISTER GOODYEAR	118
77050	GOODYEAR EDGE PORTA TELEFONO E NAVIGATORE Small	231
77051	GOODYEAR EDGE ULTRA PORTA TELEFONO/ IPAD E NAVIGATORE XL	231
77052	GOODYEAR CARICA CELLULARE DA AUTO	287
77053	GOODYEAR MULTI CARICATORE CASA-AUTO	288
77054	GOODYEAR MINI CARICATORE PER AUTO	288
77055	GOODYEAR CARICA BATTERIA CELLULARE IPHONE 4 - 5 - 6 - 6plus	288
77070	GOODYEAR COPRIVOLANTE CONFORT NERO 37-39cm	214
77071	GOODYEAR COPRIVOLANTE CONFORT GRIGIO 37-39cm	214
77072	GOODYEAR COPRIVOLANTE CONFORT BEIGE 37-39cm	214
77098	SET 2 PZ.TAPPETI ANT.GOMMA GRIGIO	175
77099	SET 2 PZ.TAPPETI ANT.GOMMA MARRONE	175

ARTICOLO	DESCRIZIONE PRODOTTO	PAG
77112	1 PZ.TAPPETO GOMMA FRONTALE NERO	176
77113	1 PZ.TAPPETO GOMMA FRONTALE GRIGIO	176
77115	1 PZ. TAPPETO GOMMA FRONTALE NERO	176
77116	1 PZ. TAPPETO GOMMA FRONTALE GRIGIO	176
77117	GOODYEAR TAPPETINO PER CRUSCOTTO IN GOMMA	228
77119BLACK	GOODYEAR FODERA UNIVERSALE NERO	211
77119BLUE	GOODYEAR FODERA UNIVERSALE BLU	211
77119GREY	GOODYEAR FODERA UNIVERSALE GRIGIO	211
77122	GOODYEAR COPRISIDILE SINGOLO TESSUTO SPECIALE	209
77123BLUE	GOODYEAR SET FODERE UNIVERSALI	210
77123GREY	GOODYEAR SET FODERE UNIVERSALI	210
77123RED	GOODYEAR SET FODERE UNIVERSALI	210
77124BLUE	GOODYEAR SET FODERE UNIVERSALI	210
77124GREY	GOODYEAR SET FODERE UNIVERSALI	210
77124RED	GOODYEAR SET FODERE UNIVERSALI	210
77127	GOODYEAR SCHIENALE COLORE BLU	209
77128	GOODYEAR SCHIENALE COLORE GRIGIO	209
77129	GOODYEAR SCHIENALE COLORE NERO	209
77130	GOODYEAR SET 4 PZ TAPPETI MOQUETTE NERO	175
77135	GOODYEAR SET 4 PZ.TAPPETO IN GOMMA UNIVERSALI	174
77136	GOODYEAR SET.4PCS TAPPETI MOQUETTE/GOMMA NERO	174
77140	GOODYEAR SET 1 TAPPETO IN GOMMA LATO GUIDA	184
77170	CRIC A BOTTIGLIA 2 TON-TUV/GS GOODYEAR	282
77171	CRIC A BOTTIGLIA 4 TON -TUV/GS GOODYEAR	282
77177	GOODYEAR TAPPETO BAULE PVC 90x50cm	225
77178	GOODYEAR TAPPETO BAULE PVC 90x100cm	225
77200	GOODYEAR COPPIA BARRE PORTATUTTO RAILINGS CM.120 FROZEN	234
77201	GOODYEAR COPPIA BARRE PORTATUTTO RAILINGS CM.135 FROZEN	234
77205	GOODYEAR CARGOBOX METALLIZZATO MAMMUTH 320 LT.	238
77206	GOODYEAR CARGOBOX METALLIZZATO MAMMUTH 450 LT.	239
77220	GOODYEAR BARRE ACCIAIO NERE CM.120 CARGO	235
77221	GOODYEAR BARRE ACCIAIO NERE CM.135 CARGO	235
77222	GOODYEAR BARRE ACCIAIO NERE CM.120 CARGO LOCK	235
77223	GOODYEAR BARRE ACCIAIO NERE CM.135 CARGO LOCK	235
77224	GOODYEAR PORTABICI POST. VOYAGER 2 BIKES	236
77225	GOODYEAR PORTABICI POST. VOYAGER 3 BIKES	236
77249	GOODYEAR PORTA 4 RUOTE MURALE RICHIUDIBILE	157
77250	GOODYEAR STRUTTURA PORTA 4 RUOTE	156
77270	SR. COPRICERCHI GOODYEAR TOURER 14" BICOLOR	154
77271	SR. COPRICERCHI GOODYEAR TOURER 15" BICOLOR	154
77272	SR. COPRICERCHI GOODYEAR TOURER 14"	154
77273	SR. COPRICERCHI GOODYEAR TOURER 15"	154
77274	SR. COPRICERCHI GOODYEAR TOURER GT 14" BICOLOR	155
77275	SR. COPRICERCHI GOODYEAR TOURER GT 15" BICOLOR	155
77340	CAVI BATTERIA PROFESS. 200 A. 8 MM. 200 CM	298
77342	CAVI BATTERIA PROFESS. 400 A. 10 MM 200 CM	298
77344	CAVI BATTERIA PROFESS. 600 A. 25 MM 300 CM	298
77350	GOODYEAR CARICA BATT.4 AMP.12V 230V	284
77352	CARICA BATT-MANTENITORE DI CARICA	284
77354	GOODYEAR TORCIA A LED MULTIFUNZIONI	129
77356	GOODYEAR ASPIRAPOLVERE 12V-60W MIDI CLEANER	77
77364	GOODYEAR COMPRESSORE STRONG 17 ATM.	279
77370	GOODYEAR TRIANGOLO EMERGENZA	304
77371	GOODYEAR GIUBBINO ALTA VISIBILITA' GIALLO	304
77372	GOODYEAR GIUBBINO ALTA VISIBILITA' ARANCIO	304
77385	GOODYEAR COPERTURA IN PEVA SINGOLA PER 4 PNEUMATICI	156
77414	PANNO MICROFIBRA VETRI GOODYEAR	56
77415	PANNO MICROFIBRA INTERNI GOODYEAR	56
77416	PANNO MICROFIBRA CARROZZERIA GY	56

ARTICOLO	DESCRIZIONE PRODOTTO	PAG
77417	PANNO MICROFIBRA MULTIUSO GOODYEAR	57
77418	GUANTO MICROFIBRA GOODYEAR	57
77419	SPUGNA MICROFIBRA GOODYEAR	57
77420	GOODYEAR PANNO IN PVA 43x32cm	54
77423	GOODYEAR ALKANTARA SCAMOSC GRANDE	54
77424	GOODYEAR PELLE SCAMOSCIATA IN MICROFIBR	54
77425	GOODYEAR PELLE SINTETICA SCAMOS.	55
77427	GOODYEAR DAINOLUX L	55
77428	GOODYEAR PANNO IN MICROFIBRA BRILL	55
77429	GOODYEAR DAINOCLEAN XL	55
77451	GOODYEAR 2 TENDINE SOCK UNIVERSALI	308
77455	PARASOLE GOODYEAR ALLUMINIO 130X60	306
77456	GOODYEAR PARASOLE ALLUMINIO STANDARD 130X60	306
77457	GOODYEAR PARAGHIACCIO ESTERNO INVERNALE PER VETRO GUIDA	307
77460	PARASOLE GOODYEAR ALLUMINIO 150X80	306
77467	GOODYEAR CRIC A PANTOGRAFO 1 TON -TUV/GS	282
77468	GOODYEAR CRIC A CARRELLO 2 TON -TUV/GS	282
77470	GOODYEAR COPRIAUTO ANTIGRANDINE 406X165	80
77472	GOODYEAR COPRIAUTO ANTIGRANDINE 482X178	80
77474	GOODYEAR COPRIAUTO ANTIGRANDINE 533X178	80
77480	PROTEGGI SEDILE ANTERIORE NERO	30
77481	PROTEGGI SEDILI POSTERIORI	30
77482	PROTEGGI VANO DI CARICO	30
77483	BORSA TRASPORTINO	31
77484	SEPARA SEDILE E ORGANIZER	31
77485	RETE DI PROTEZIONE E DI SEPARAZIONE 90X70	31
77486	GRIGLIA DI VENTILAZIONE FINESTRINO E SICUREZZA	32
77487	SET BORSA CIBO E CIOTOLA IMPERMEABILE	32
77488	SPAZZOLA IN GOMMA TOGLI PELI	32
77489	RULLO RIMUOVI PELI	33
77490	GUINZAGLIO CON CONNETTORE CINTURA DI SICUREZZA	33
77491	CONNETTORE CINTURA DI SICUREZZA	33
77492	PULITORE TESSUTI/MOQUETTE AUTO 750 ML	34
77493	PULITORE INTERNAUTO IN PELLE 750 ML.	34
77494	PULITORE PLASTICHE AUTO 750 ML.	35
77495	SGRASSATORE TRASPORTINI E LETTIERE 750 ML.	35
77496	RIMUOVI ODORI 750 ML.	35
77497	DISSUASORE CANI E GATTI PER 750 ML.	35
77498	RETE DI SEPARAZIONE	33
77499	GRIGLIA DI SEPARAZIONE/SICUREZZA 2 ELEMENTI	34
77500	GRIGLIA DI SEPARAZIONE/SICUREZZA 3 ELEMENTI	34
77501	BATTERIA GOODYEAR 40 AMP" POWER PLUS "	22
77504	BATTERIA GOODYEAR 45 AMP" POWER PLUS "	22
77507	BATTERIA GOODYEAR 50 AMP" POWER PLUS "	22
77510	BATTERIA GOODYEAR 55 AMP" POWER PLUS "	23
77513	BATTERIA GOODYEAR 60 AMP" POWER PLUS "	23
77516	BATTERIA GOODYEAR 70 AMP" POWER PLUS "	23
77519	BATTERIA GOODYEAR 80 AMP" POWER PLUS "	24
77522	BATTERIA GOODYEAR 90 AMP" POWER PLUS "	24
77525	BATTERIA GOODYEAR 100 AMP" POWER PLUS "	24
77560	TRATTAMENTO MULTIFUNZIONE SPECIFICO PER DIESEL-GASOLIO	49
77561	TRATTAMENTO MULTIFUNZIONE SPECIFICO PER BENZINA	49
77563	GOODYEAR ADDIT GASOLIO A/CONG	49
77600	GOODYEAR SPAZZOLA TERGI FLAT RAIN MASTER 330 MM. " NEW TECHNOLOGY "	96
77601	GOODYEAR SPAZZOLA TERGI FLAT RAIN MASTER 350 MM. " NEW TECHNOLOGY "	96
77602	GOODYEAR SPAZZOLA TERGI FLAT RAIN MASTER 380 MM." NEW TECHNOLOGY "	96

ARTICOLO	DESCRIZIONE PRODOTTO	PAG
77603	GOODYEAR SPAZZOLA TERGI FLAT RAIN MASTER 410 MM. " NEW TECHNOLOGY "	96
77604	GOODYEAR SPAZZOLA TERGI FLAT RAIN MASTER 450 MM. " NEW TECHNOLOGY "	96
77605	GOODYEAR SPAZZOLA TERGI FLAT RAIN MASTER 480 MM. " NEW TECHNOLOGY "	96
77606	GOODYEAR SPAZZOLA TERGI FLAT RAIN MASTER 510 MM. " NEW TECHNOLOGY "	96
77607	GOODYEAR SPAZZOLA TERGI FLAT RAIN MASTER 530 MM. " NEW TECHNOLOGY "	96
77608	GOODYEAR SPAZZOLA TERGI FLAT RAIN MASTER 550 MM. " NEW TECHNOLOGY "	96
77609	GOODYEAR SPAZZOLA TERGI FLAT RAIN MASTER 600 MM. " NEW TECHNOLOGY "	96
77610	GOODYEAR SPAZZOLA TERGI FLAT RAIN MASTER 650 MM. " NEW TECHNOLOGY "	96
77611	GOODYEAR SPAZZOLA TERGI FLAT RAIN MASTER 700 MM. " NEW TECHNOLOGY "	96
77615	GOODYEAR 2 PZ. REFILL C/GRAFITE 610 MM RAIN CONTROL " NEW TECHNOLOGY "	97
77616	GOODYEAR 2 PZ. REFILL C/GRAFITE 700 MM RAIN CONTROL " NEW TECHNOLOGY "	97
77641	SPAZZOLA TERGI C/GRAFITE 330 MM GOODYEAR RAIN CONTROL " NEW TECHNOLOGY "	96
77642	SPAZZOLA TERGI C/GRAFITE 350 MM GOODYEAR RAIN CONTROL " NEW TECHNOLOGY "	96
77643	SPAZZOLA TERGI C/GRAFITE 380 MM GOODYEAR RAIN CONTROL " NEW TECHNOLOGY "	96
77644	SPAZZOLA TERGI C/GRAFITE 410 MM GOODYEAR RAIN CONTROL " NEW TECHNOLOGY "	96
77645	SPAZZOLA TERGI C/GRAFITE 450 MM GOODYEAR RAIN CONTROL " NEW TECHNOLOGY "	96
77646	SPAZZOLA TERGI C/GRAFITE 480 MM GOODYEAR RAIN CONTROL " NEW TECHNOLOGY "	96
77647	SPAZZOLA TERGI C/GRAFITE 510 MM GOODYEAR RAIN CONTROL " NEW TECHNOLOGY "	96
77648	SPAZZOLA TERGI C/GRAFITE 530 MM GOODYEAR RAIN CONTROL " NEW TECHNOLOGY "	96
77649	SPAZZOLA TERGI C/GRAFITE 550 MM GOODYEAR RAIN CONTROL " NEW TECHNOLOGY "	96
77650	SPAZZOLA TERGI C/GRAFITE 600 MM GOODYEAR RAIN CONTROL " NEW TECHNOLOGY "	96
77651	SPAZZOLA TERGI C/GRAFITE 650 MM GOODYEAR RAIN CONTROL " NEW TECHNOLOGY "	96
77701	GOODYEAR SALVIETTE UMIDIFICATE PUL. PLASTICHE OPACO 20 PZ.	54
77702	GOODYEAR SALVIETTE UMIDIFICATE PUL. PLASTICHE LUCIDO 20 PZ.	53
77703	GOODYEAR SALVIETTE UMIDIFICATE TRATTAMENTO PELLE 20 PZ.	53
77704	GOODYEAR SALVIETTE UMIDIFICATE INTERNI E TESSUTI 20 PZ.	53
77705	GOODYEAR SALVIETTE UMIDIFICATE VETRI 20 PZ.	53
77801	GOODYEAR DETERGENTE TESSUTI MOQUETTE 750CC	36
77802	GOODYEAR DETERG.VETRI FLACONE 750ML	36
77803	GOODYEAR DETERGENTE UNIVERSALE FLACONE 750CC.	36
77804	GOODYEAR LUCIDA E RINNOVA CRUSCOTTI 750 CC.	39
77805	GOODYEAR TRATTAMENTO PELLE 750 ML	37
77806	GOODYEAR CERA LIQUIDA AUTO 750 ML	37
77807	GOODYEAR SHAMPOO AUTO 1 LITRO	38
77808	GOODYEAR SHAMPOO E CERA AUTO 1 LITRO	38
77816	GOODYEAR CERA LUCIDANTE 250 ml	37
77817	GOODYEAR PASTA ABRASIVA 250 ml	49
77818	GOODYEAR SHAMPOO AUTO 5 LITRI	38
77819	GOODYEAR LIQUIDO VASCHETTA TERGI -20° INVERN.	42
77820	GOODYEAR LUCIDANTE CRUSCOTTI 750CC PINO	39
77821	GOODYEAR LUCIDANTE CRUSCOTTI 750CC VANIGLIA	39
77822	GOODYEAR LIQUIDO CRUSCOTTI 750CC LIMONE	39

ARTICOLO	DESCRIZIONE PRODOTTO	PAG
77831	GOODYEAR IGIENIZZANTE CLIMA 400 ml	44
77834VANIGLIA	GOODYEAR LUCIDANTE CRUSCOTTI VANIGLIA 450ml	39
77834LIMONE	GOODYEAR LUCIDANTE CRUSCOTTI LIMONE/LEMON 450ml	39
77834OCEANO	GOODYEAR LUCIDANTE CRUSCOTTI OCEANO/OCEAN 450ml	39
77834PINO	GOODYEAR LUCIDANTE CRUSCOTTI PINO 450ml	39
77836PINO	GOODYEAR LUCIDANTE CRUSCOTTI PINO 250ml	40
77836LIMONE	GOODYEAR LUCIDANTE CRUSCOTTI LIMONE/LEMON 250ml	40
77836OCEANO	GOODYEAR LUCIDANTE CRUSCOTTI OCEANO/OCEAN 250ml	40
77836ROSA	GOODYEAR LUCIDANTE CRUSCOTTI ROSA/ROSE 250ml	40
77836FRAGOLA	GOODYEAR LUCIDANTE CRUSCOTTI FRAGOLA 250ml	40
77836VANIGLIA	GOODYEAR LUCIDANTE CRUSCOTTI VANIGLIA 250ml	40
77837	GOODYEAR LUCIDA NERO GOMME SCHIUMA 650 ML	40
77838	GOODYEAR LIQ.VASCHET.TERGI 2 lt	42
77839	GOODYEAR LIQ.VASCHET.TERGI 5lt	42
77840	GOODYEAR SBLOKKA LUBRIF. 450 ML.	50
77841	GOODYEAR SBLOKKA LUBRIFIC.250 ML	50
77842	GOODYEAR LIQ.RADIATORI ROSSO -22 LT.1	45
77843	GOODYEAR LIQ.RADIATORI BLU -22 LT.1	45
77844	GOODYEAR LIQ. RADIATORI ROSSO -22 LT.5	45
77845	GOODYEAR LIQ.RADIATORI BLU -22 LT.5	45
77846	GOODYEAR LIQ.RADIATORI -30 VIOLA 1 LT.	46
77847	GOODYEAR LIQ.RADIATORI -30 VERDE 1 LT.	46
77848	GOODYEAR LIQ.RADIATORI -30 GIALLO 1 LT.	46
77849	GOODYEAR LIQ.RADIATORI -30 ROSSO 1 LT.	46
77851	GOODYEAR LIQ.RADIATORI ANTIGELO 5lt PRONTO ALL`USO	47
77852	GOODYEAR DETERG. TESS.MOQUETTE 650ML NUOVA FORMULA	36
77853	GOODYEAR CLIMA IGIENIZZANTE 200 ML	44
77854	GOODYEAR DETERG.CERCHI 750 ML	41
77855	GOODYEAR NERO GOMME 750 ML	41
77856	GOODYEAR LIQUIDO FRENI DOT 4 250 ML	50
77857	GOODYEAR SVITA E LUBRIFICA 450 ML	50
77858	GOODYEAR NERO GOMME RAVVIVANTE 1 LT.	41
77859	GOODYEAR LIQ.LAVAV.-40 250 ML	43
77860	GOODYEAR LIQ.LAVAV.PLURISTAG. 250 ML	43
77861	GOODYEAR CERA SPRAY PROTETTIVA 600 ML	37
77862	GOODYEAR CERA POLISH LUCIDANTE 600 ML	38
77863	GOODYEAR 2 IN 1 LUCIDA E PROTEGGE 600 ML	39
77864	GOODYEAR 6 IN 1 RIM. RESINA/CATR. 600 M	39
77867	GOODYEAR LIQ.LAVAV.INVERNALE -26Â° LT.2	43
77868	GOODYEAR LUCI DIURNE 8 LED "DAY LIGHT"	129
77873	GOODYEAR 2 PZ DA 50 ML.LAVAVETRO VASCHETTA	43
77874	GOODYEAR DETERG. CASCO E VISIERE	52
77875	GOODYEAR LIQ.RADIAT.BLU -22° INVERN. LT.2	48
77876	2 BOBINE CARTA ASCIUGATUTTO	51
77882	LIQUIDO RADIATORE GIALLO PLURISTAGIONALE 1 LT.	47
77883	LIQUIDO RADIATORE ROSSO PLURISTAGIONALE 1 LT.	47
77884	GOODYEAR CROMATURE BRILLANTI	51
77885	GOODYEAR LUCIDA CARENAT-PLASTICHE	52
77888	GOODYEAR PANNI LUCIDANTE MOTO	52
77889	GOODYEAR GUANTO LUCIDA MOTO	52
77890	GOODYEAR DEGHIACC. DE ICE 250 ML	44
77891	GOODYEAR DEGHIACC.DE-ICE 450 ML	44
77892	GOODYEAR LUCIDA CRUSCOTTI LUCID.650 ML	40
77893	GOODYEAR LUCIDA CRUSCOTTI SATIN.650 ML	40
77894	GOODYEAR RADIATORI `RADI AFLUIDO` LT.2	48
77895	GOODYEAR RADIATORI `RADI AFLUIDO` LT.1	48
77896	GOODYEAR RIMUOVI GRAFFI 150 ML	51
77897	GOODYEAR RINNOVA FANALI 150 ML	51
77898	GOODYEAR LIQ.RADIAT.PLURISTAGION.1LT.	48
77898ESPO	ESPOSITORE A SCALETTA GOODYEAR	457
77899	ESPOSITORE CHIMICO GOODYEAR	454

ARTICOLO	DESCRIZIONE PRODOTTO	PAG
77900	CATENA NEVE GOODYEAR 9MM 020	138
77901	CATENA NEVE GOODYEAR 9 MM 030	138
77902	CATENA NEVE GOODYEAR 9 MM 040	138
77903	CATENA NEVE GOODYEAR 9 MM 050	138
77904	CATENA NEVE GOODYEAR 9MM 060	138
77905	CATENA NEVE GOODYEAR 9MM 070	138
77906	CATENA NEVE GOODYEAR 9MM 080	138
77907	CATENA NEVE GOODYEAR 9 MM 090	138
77908	CATENA NEVE GOODYEAR 9MM 100	138
77909	CATENA NEVE GOODYEAR 9MM 045	138
77910	CATENA NEVE GOODYEAR 9MM 095	138
77911	CATENA NEVE GOODYEAR 9MM 065	138
77912	CATENA NEVE GOODYEAR 9MM 110	138
77913	CATENA NEVE GOODYEAR 9MM 120	138
77914	CATENA NEVE GOODYEAR 9MM 130	138
77915	CATENA NEVE GOODYEAR 9MM 75	138
77916	CATENA NEVE GOODYEAR 9MM 140	138
77930	GOODYEAR CATENA NEVE 12mm 225	137
77931	GOODYEAR CATENA NEVE 12mm 227	137
77932	GOODYEAR CATENA NEVE 12mm 230	137
77933	GOODYEAR CATENA NEVE 12mm 235	137
77934	GOODYEAR CATENA NEVE 12mm 240	137
77935	GOODYEAR CATENA NEVE 12mm 245	137
77936	GOODYEAR CATENA NEVE 12mm 247	137
77937	GOODYEAR CATENA NEVE 12mm 250	137
77938	GOODYEAR CATENA NEVE 12mm 255	137
77950	GOODYEAR CATENA NEVE 7mm misura 60	135
77951	GOODYEAR CATENA NEVE 7mm misura 65	135
77952	GOODYEAR CATENA NEVE 7mm misura 70	135
77953	GOODYEAR CATENA NEVE 7mm misura 80	135
77954	GOODYEAR CATENA NEVE 7mm misura 90	135
77955	GOODYEAR CATENA NEVE 7mm misura 100	135
77956	GOODYEAR CATENA NEVE 7mm misura 110	135
77957	GOODYEAR CATENA NEVE 7mm misura 120	135
77958	GOODYEAR CATENA NEVE 7mm misura 130	135
92522	POMPA PROF. ALLUM.C/MANOMETRO DE-LUXE	432
96000N	CATENA 116 MAGLIE MTB UNIVERSALE	425
96020N	TIRARAGGI CROMATO IN ALLUMINIO	428
96030N	CP. PEDALI LUSO CON CATARIFRANGENTI	408
96031N	CP. PEDALI MTB CON CATARIFRANGENTI	408
96045N	SERIE 4 PATTINI FRENO PROFESSIONAL	418
96046N	COPPIA PATTINI PROFESSIONALI MTB	418
96048N	SERIE 2 PATTINI FRENO MTB	418
96055N	KIT GUAINA FILO FRENI 300 CM	419
96056N	SET 2 FILI FRENO C/GUAINA NERA	419
96060N	SET 2 FILI FRENO MTB C/GUAINA NERA	419
96062N	SET 2 FILI FRENO MTB/CITY BIKE 85CM ANT.	420
96063N	SET 2 FILI FRENO MTB/CITY BIKE 155CM POST.	420
96064N	SET 2 FILI FRENO RACING ANTER. 85 CM	420
96065N	SET 2 FILI FRENO RACING POST. 140 CM	420
96066N	SET 2 FILI FRENO SPORT ANTER. 85CM	421
96067N	SET 2 FILI FRENO SPORT POST. 175CM	421
96080N	KIT FRENI ANT/POST V-BRAKE	422
96082N	KIT FRENI ANT/POST CANTILEVER	418
96100N	SET 2 LEVE FRENI ALLUM. ALLEGGERITO	422
96120N	SET 2 LEVE FRENI IN RESINA	422
96125N	CAVALLETTO IN ALLUMINIO ULTRALEGGERO	414
96127N	CAVALLETTO UNIV. TELESCOPICO REGOLABILE	414
96135N	SERIE 2 PEZZI MANOPOLE MTB/SPORT	400
96136N	SERIE 2 PZ MANOPOLE CLASSICHE	400
96137N	SERIE 2PZ MANOPOLE PROFESS. CON GEL	401

ARTICOLO	DESCRIZIONE PRODOTTO	PAG
96150N	PAIA APPENDICI PROFESSIONALI ALLUM.	401
96180N	SELLA TURISMO CRUISER SOFT-LINE NERA	405
96182N	SELLA SPORT SOFT-LINE NERA	406
96183N	SELLA SPORT MARRONE	406
96184N	SELLA MTB SOFT LINE NERA	406
96187N	SELLA TURISMO/CRUISER PREMIUM MARRONE	405
96190N	COPRISELLA IN EXTRA-GEL SPORT/TURISMO	407
96191N	COPRISELLA IN EXTRA-GEL MTB	407
96192N	COPRISELLA IMPERM. MTB WATERPROOF	407
96200N	DINAMO UNIVERSALE NERA	408
96201N	DINAMO UNIVERSALE CROMATA	408
96290N	KIT 2 LAMP. RICAMBIO ANT/POST	394
96295N	GONFIA E RIPARA PNEUM. PROFESS. 100 ML	428
96296N	LUBRIFICANTE CATENE PROFES. 250 ML	428
96297N	KIT GONFIAG. 1 REGOLATORE FLUSSO+BOMB.CO2	433
96298N	1 BOMBOLETTA CO2 GONF. RICAMBIO PROF.	434
96311N	FARO ANT. LED BIANCHI 2 FUNZ.	392
96312N	FARO POSTER. LED 2 FUNZIONI	393
96313N	PROIETT. ANT. ALOGENO+3LED	392
96314N	PROIETT. ANT. PROFESS. 5LED	392
96316N	PROIETT. POST. 5LED PROFES.	393
96318N	PROIETT. ANT. ALOGENO PROF.	392
96320N	SET PROIETTORI ANTERIORE/POSTERIORE A LED	396
96322N	SET PROIETTORI ANTERIORE/POSTERIORE A LED	396
96330N	RIFLETTORE POSTERIORE LUMINOSO	393
96332N	SET 2 CATARIFR. PER RUOTE	395
96333N	RIFLETTORE POST. ATTACCO PORTAPACCHI	393
96334N	SET 2 CATARIFRANG. PER RUOTE LUSO	395
96350N	SET 2 CATARIFR. BIANCO/ROSSO + ATTACCHI	395
96500N	SET RIPARA GOMME	427
96501N	KIT CHIAVI RIPAR. PROFESS. 9 FUNZ.	424
96502N	POMPA BICI GARAGE CON DOPPIA VALVOLA	432
96503N	POMPA IN ALLUMINIO PRO-RACE	433
96504N	POMPA OFFICINA C/ATT. DP. MULTIVALVOLE	432
96505N	POMPA IN ALLUMINIO PROFESSIONAL	433
96506N	POMPA CLASSICA NERA	433
96508N	CHIAVE SET MULTIFUNZIONE 10 IN 1	424
96510N	SET 66 PEZZI RICAMBI ASSORTITI	426
96511N	SET MULTIUSO CHIAVI ESAGOLANI DE-LUXE	424
96512N	POMPA BICI GARAGE SALVASPAZIO DOPPIA VALVOLA CON FERMO PIEDE	432
96517N	RACCORDO POMPA TUBOLARE	434
96520N	RACCORDO POMPA IN ACCIAIO+2 GOMMINI	434
96540N	SET 3 CHIAVI LEVAGOMME IN METALLO	425
96545N	SET 3 CHIAVI LEVAGOMME IN NYLON	425
96550N	SET PEZZE RIPARAZIONE CAMERA ARIA	428
96555N	MASTICE PER RIPARAZIONE CAMERA ARIA	426
96560N	KIT RIPARA BICICLETTA COMPLETO	427
96565N	KIT CHIAVI RIPARAZ. PROFESS.+ACCESS.	427
96577N	CAMERA ARIA 27,5X1,9-2,5 PRESTA 48MM	441
96578N	CAMERA ARIA 29X1,9-2,5 PRESTA 48MM	441
96579N	CAMERA ARIA C/VALV. AMERICANA 28x1-5/8x1-3/8 / 700x35c	440
96580N	CAMERA ARIA C/VALVOLA 16X1.75 BIMBO VALVOLA ITALIA	440
96581N	CAMERA ARIA BMX 20X1.75/95 VALVOLA ITALIA	440
96582N	CAMERA ARIA CON VALVOLA 20X1.75 VALVOLA ITALIA	441
96584N	CAMERA ARIA CON VALVOLA 24X1.75 VALVOLA ITALIA	441
96586N	CAMERA ARIA CON VALVOLA 26X1-3/8 VALVOLA ITALIA	441
96588N	C/ARIA C/VALVOLA 28X1-5/8X1-3/8 700X35 C VALVOLA ITALIA	441
96590N	CAMERA ARIA CON VALV. 26X1.75-1.95-2.125 MTB VALVOLA ITALIA	441
96594N	CAMERA ARIA C/VALV. 28 BICI CORSA 700x23C VALVOLA FRANCIA	440
96595N	CAMERA ARIA VALV. AMERICANA 16x1,75-1,95	441



ARTICOLO	DESCRIZIONE PRODOTTO	PAG
96596N	CAMERA ARIA VALV. AMERICANA 20x1.50/1.75	441
96597N	CAMERA ARIA VALV. AMERICANA 24x1.50/1.75	441
96598N	CAMERA ARIA VAL. AMERICANA 26X1,90-1,95-2,125	441
96599N	CAMERA ARIA C/VALV. AMERICANA 26x1-3/8	441
96600N	PNEUMATICO STRADA 16X1.75 BIMBO	442
96602N	PNEUMATICO MTB 16X1.75 BIMBO	442
96604N	PNEUM. MTB RAGAZZO 20X1.75	442
96606N	PNEUM. NERO 20X1.75 "STREET	443
96608N	PNEUM. MTB RAGAZZO 24X1.75	443
96610N	PNEUM. NERO 24X1.75 STREET UOMO/DONNA	443
96612N	PNEUM. NERO DONNA 26X1-3/8	444
96614N	PNEUMATICO MTB 26X2.125 UOMO/DONNA	444
96616N	PNEUM. MTB UOMO/DONNA 26X1.90 - 1.95	444
96618N	PNEUM. MTB UOMO/DONNA 26X1.75 SLICK	445
96620N	PNEUM. NERO UOMO 28X1-5/8-3/8 / 700x35C	445
96621N	PNEUMATICO CITY BIKE 28" STRETTO 700x23C	445
96622	PNEUMATICO MTB 27,5X2,25	446
96623	PNEUMATICO MTB 29 X 2,125	446
96750N	ANTIFURTO CON CHIAVE	430
96752N	ANTIFURTO C/COMBINAZIONE	430
96754N	ANTIFURTO CATENA C/LUCCHET.	430
96757N	CAVO ANTIF. C/LUCCHETTO	430
96760N	ANTIFURTO PROFESSIONALE BICI KOMPATTO	431
96761N	ANTIFURTO A TELAIO NERO DE-LUXE	431
96762N	ANTIFURTO A TELAIO CROMATO DE-LUXE	431
96763N	ANTIFURTO A CAVO MASTER 66 RINFORZATO	431
96800N	CASCO PROF. OMOLOG. ADULTO UOMO/DONNA MIS. S	437
96802N	CASCO PROF. OMOLOG. ADULTO UOMO/DONNA MIS. M	437
96804N	CASCO PROF. OMOLOG. ADULTO UOMO/DONNA MIS. L	437
96806N	CASCHETTO SICUR. OMOL BAMBINO/BAMBINA MISURA S	438
96808N	CASCHETTO SICUR. OMOL. BAMBINO/BAMBINA MISURA M	438
96860N	COPIA PARAFANGHI ANT/POST CLASSIC	416
96862N	PARABREZZA BAMBINO/BAMBINA LUXURY	412
96870N	CORDA ELASTICA PER PORTAPACCHI BICI	416
96880N	CESTINO ANT. IN METALLO CON GANCI NETTY	410
96881N	CESTINO ANTERIORE METALLO OLANDA C/GANCI	411
96882N	CESTINO ANT. IN METALLO CON GANCI GERMAN	410
96884N	CESTINO POST. IN METALLO NETTY	410
96890N	PORTAPACCHI BICI ANTERIORE	411
96891N	PORTAPACCHI MTB POSTERIORE	411
96896N	PORTA BICI A TERRA 1 POSTO	448
96897N	PORTA BICI A TERRA 3 POSTI	448
96898N	PORTA BICI A TERRA 5 POSTI	449
96900N	CP. RUOTE STABILIZ. C/ATTACCHI 12 POLLICI	447
96901N	CP. RUOTE STABILIZ. C/ATTACCHI 14 POLLICI	447
96902N	CP. RUOTE STABILIZ. C/ATT. UNIV. 12/20 POLLICI	447
96906N	COPRIBICI UNIVERS. 200X100 CM	416
96910N	CAMPANELLO BICI ROUND CROMATO	398
96911N	CAMPANELLO BICI CLASSICO COL. ASSORTITI	398
96913N	CAMPANELLO BICI ASSORTITO	398
96914N	CAMPANELLO BICI I LOVE MY BIKE	398
96915N	CAMPANELLO BICI COLOURFUL	399
96916N	CAMPANELLO CROMATO CLASSIC	399
96920N	KIT PORTABORRAC. +BORRACCIA FRESH	402
96922N	P/BORRACCIA LEGA+BORRACCIA DEMON	402
96924N	BORRACCIA ALL.TERMICA PROFESSIONALE	402
96925N	PORTABORRACCIA MTB IN LEGA LEGGERA	401
96950N	BRETELLE OMOLOGATE DI SEGNALAZIONE	434
96960N	SEGGIOLINO POST. ATTACCO AL TELAIO OMOLOGATO	412
96965N	SEGGIOL. ANT. ATTACCO AL TELAIO OMOLOGATO	412
96970N	BORSETTA SOTTOSELLA PORTA ATTREZZI	413

ARTICOLO	DESCRIZIONE PRODOTTO	PAG
96971N	BORRACCIA ALLUMINIO TERMICA BIMBO	402
96972N	TROMBETTA BIMBO FANTASIE E COLORI ASS.	403
96973N	TROMBETTA BIMBO FANTASIE E COLORI ASS.	403
96974N	SET 12 PZ. DECORAZ. RAGGI RUOTE BIMBO	403
96975N	SET 4 PZ. CATARIFR. COLORATI BIMBO	395
96976N	SPECCHIETTO BIMBO FLESS. DESTRO/SIN.	400
96980N	BORSA ANT. WATERPROOF C/PORTA CARTINA	413
96981N	SPALLACCIO PROFESSIONALE	413
96983N	PAIA GUANTI CICLISTA MIS. S	435
96984N	PAIA GUANTI CICLISTA MIS. M	435
96985N	PAIA GUANTI CICLISTA MIS. L	435
96986N	PAIA GUANTI CICLISTA MIS. XL	435
96989N	SPECCHIO BICI DA UOMO CLASSICO	400
96990N	CICLO COMP. 9 FUNZIONI	404
96991N	CICLO COMPUTER DA BICI 12 FUNZIONI	404
96992N	CICLO COMPUTER WIRELESS 16 FUNZIONI	404
97200GANC21CM	ESPOSITORE CON GANCIO 21 CM	461
97200GANC25CM	ESPOSITORE CON GANCIO 25 CM	461
98101	100 GUANTI LATTICE USA E GETTA -S PROFESSIONALI	321
98102	100 GUANTI LATTICE USA E GETTA -M PROFESSIONALI	321
98103	100 GUANTI LATTICE USA E GETTA - L PROFESSIONALI	321
98124	100 PZ GUANTI IN VINILE S/TALCO - S BIANCO PROFESSIONALI " ANALLERGICI "	321
98125	100 PZ GUANTI IN VINILE S/TALCO - M BIANCO PROFESSIONALI " ANALLERGICI "	321
98126	100 PZ GUANTI IN VINILE S/TALCO - L BIANCO PROFESSIONALI " ANALLERGICI "	321
98131	100 GUANTI NITRILE BLU USA & GETTA -S PROFESSIONALI	321
98132	100 GUANTI NITRILE BLU USA E GETTA-M PROFESSIONALI	321
98133	100 GUANTI NITRILE BLU USA E GETTA-L PROFESSIONALI	321
EXPOPLASTIC	ESPOSITORE IN PS 4 PIANI	459
ESPO 32238	ESPOSITORE PER ART. 32236-32237 SPAZZOLONE CON MANICO TELESCOPICO	453
TA102238	ARBRE MAGIQUE MENTA GLACIALE	273
TA102240	ARBRE MAGIQUE SPORT	273
TA102252	ARBRE MAGIQUE COCCO	273
TA102254	ARBRE MAGIQUE FRUIT COCKTAIL	273
TA102256	ARBRE MAGIQUE FRUTTI DI BOSCO	273
TA102258	ARBRE MAGIQUE LEMON	273
TA102260	ARBRE MAGIQUE MELA VERDE	273
TA102262	ARBRE MAGIQUE PINO	273
TA102268	ARBRE MAGIQUE VANIGLIA	273
TA102270	ARBRE MAGIQUE LAVANDA	273
TA102274	ARBRE MAGIQUE FRAGOLA	273
TA102278	ARBRE MAGIQUE AUTO NUOVA	273
TA102282	ARBRE MAGIQUE BLACK PINE	273
TA102290	ARBRE MAGIQUE FRESH WATER	273
TA102294	ARBRE MAGIQUE CASHMERE FLOWER	273
TA102298	ARBRE MAGIQUE TARTAN COLOGNE	273
TA102300	ARBRE MAGIQUE VINTAGE FRUIT	273
TA102306	ARBRE MAGIQUE GREEN FOREST & BERGAMOTTO	273
TA102308	ARBRE MAGIQUE JASMINE & NARCISSUS	273
TA102310	ARBRE MAGIQUE VIOLET & GARDENIA	273
TA102312	ARBRE MAGIQUE MUSCHIO BIANCO	273
TA102320	ARBRE MAGIQUE ITALIAN BREEZE	273
TA102322	ARBRE MAGIQUE IBIZA COCKTAIL	273
TA102324	ARBRE MAGIQUE BREZZA DI MYCONOS	273
TA102326	ARBRE MAGIQUE AGRUMI DI CAPRI	273
TA102328	ARBRE MAGIQUE COLONIA	273
TA102330	ARBRE MAGIQUE MANGO & PAPAYA	273

BOTTARI SPA È CERTIFICATA ISO 9001:2015

La Bottari Spa ha sviluppato il proprio Sistema di Gestione per la Qualità rispondente ai requisiti della norma UNI EN ISO 9001:2015

La norma ISO 9001 definisce i requisiti per la realizzazione, in una organizzazione, di un sistema di gestione della qualità; la sua ultima revisione è avvenuta nel 2015 con la ISO 9001:2015.

La ISO 9001 è la normativa di riferimento per sottoporre a controllo qualità il processo in modo ciclico, partendo dalla definizione dei requisiti dei clienti, arrivando fino al monitoraggio di tutto il percorso/processo produttivo.

Il cliente e la sua soddisfazione sono al centro dell'attenzione della Bottari Spa e della ISO 9001; ogni attività, applicazione e monitoraggio delle attività/processi sono infatti volte a determinare il massimo soddisfacimento dell'utilizzatore finale e del cliente. Le fasi di applicazione della norma partono dalla definizione delle procedure e registrazioni per ogni singolo processo o macro processo identificato all'interno dell'organizzazione aziendale.

SI PASSA ATTRAVERSO TUTTE LE AREE DELL'ORGANIZZAZIONE,
TRE LE QUALI IN PARTICOLARE:

LA DIREZIONE AZIENDALE
LA PIANIFICAZIONE
IL MARKETING
LA PROGETTAZIONE
LA VENDITA
L'APPROVVIGIONAMENTO
L'ASSISTENZA POST VENDITA

Il tutto con un'attenta analisi delle opportunità aziendali e della definizione della missione e visione aziendale espressa attraverso la politica della qualità.

Bottari Spa è da sempre attenta agli aspetti qualitativi sia del prodotto distribuito che dei processi aziendali: il conseguimento della Certificazione ISO 9001:2015 è la consacrazione degli sforzi profusi negli anni verso l'ottica di un costante, preciso e maturo percorso di crescita nella direzione della massima soddisfazione del cliente.





FODERE
TAPPETI



TERGICRISTALLO



ACCESSORI
ESTERNI E INTERNI



ACCESSORI
CICLO E
MOTO



BOTTARI IS PRESENT ON THE
 NATIONAL MARKET
 AND ABROAD WITH ITS OWN
 BRANDS:
 BOTTARI,
 R.EVOLUTION,
 R.EVOLUTION MOTORBIKE,
 GOODBYKE,
 X-TRA,
 WIPER
 AND WITH MANY LICENSED
 BRANDS, AMONG WHICH
 GOODYEAR,
 AND
 GULF.





The right way for your business

WE INVENT, CREATE, INNOVATE, IMPROVE



Via Tavogliere 6D/E - 46030 Pomponesco Mantova, Italy
Tel. (+39) 0375.868111 - Fax (+39) 0375.868160
Cod. Fisc. Plva 01651150201
bottari@bottari.it - www.bottari.it

INVENTA - CREA - INNOVA - MIGLIORA

Via Tavogliere 6D/E - 46030 Pomponesco Mantova, Italy
Tel. (+39) 0375.868111 - Fax (+39) 0375.868160
Cod. Fisc. Plva 01651150201
bottari@bottari.it - www.bottari.it

INVENTA - CREA - INNOVA - MIGLIORA

Via Tavogliere 6D/E - 46030 Pomponesco Mantova, Italy
Tel. (+39) 0375.868111 - Fax (+39) 0375.868160
Cod. Fisc. Plva 01651150201
bottari@bottari.it - www.bottari.it

INVENTA - CREA - INNOVA - MIGLIORA

Via Tavogliere 6D/E - 46030 Pomponesco Mantova, Italy
Tel. (+39) 0375.868111 - Fax (+39) 0375.868160
Cod. Fisc. Plva 01651150201
bottari@bottari.it - www.bottari.it

INVENTA - CREA - INNOVA - MIGLIORA





CONTATTO _____

TELEFONO _____



CONTATTO _____

TELEFONO _____



CONTATTO _____

TELEFONO _____



CONTATTO _____

TELEFONO _____

Via Tavogliere 6D/E - 46030 Pomponesco Mantova, Italy
Tel. (+39) 0375.868111 - Fax (+39) 0375.868160
Cod. Fisc. Plva 01651150201
bottari@bottari.it - www.bottari.it

INVENTA - CREA - INNOVA - MIGLIORA

Via Tavogliere 6D/E - 46030 Pomponesco Mantova, Italy
Tel. (+39) 0375.868111 - Fax (+39) 0375.868160
Cod. Fisc. Plva 01651150201
bottari@bottari.it - www.bottari.it

INVENTA - CREA - INNOVA - MIGLIORA

Via Tavogliere 6D/E - 46030 Pomponesco Mantova, Italy
Tel. (+39) 0375.868111 - Fax (+39) 0375.868160
Cod. Fisc. Plva 01651150201
bottari@bottari.it - www.bottari.it

INVENTA - CREA - INNOVA - MIGLIORA

Via Tavogliere 6D/E - 46030 Pomponesco Mantova, Italy
Tel. (+39) 0375.868111 - Fax (+39) 0375.868160
Cod. Fisc. Plva 01651150201
bottari@bottari.it - www.bottari.it

INVENTA - CREA - INNOVA - MIGLIORA





CONTATTO _____

TELEFONO _____



CONTATTO _____

TELEFONO _____



CONTATTO _____

TELEFONO _____



CONTATTO _____

TELEFONO _____



RINGRAZIA

www.Bottari.it
Bottari
I T A L Y

Inventa, Crea,
Innova, Migliora.

Specializzati nella
produzione di Accessori
Auto, Moto, Bici, Veicoli
Commerciali e Camion.



BOTTARI S.p.A.

Via Tavogliere, 6D/E
46030 POMPONESCO (MN) ITALY
Tel. +39 0375 868111
Fax +39 0375 868150
e-mail: bottari@bottari.it
Web-Site: www.bottari.it

